



**PARA LIGHT ELECTRONICS CO., LTD.**

11F., No. 8, Jiankang Rd., Zhonghe Dist., New Taipei City 235, Taiwan,

Tel: 886-2-2225-3733

Fax: 886-2-2225-4800

E-mail: [para@para.com.tw](mailto:para@para.com.tw)

<http://www.para.com.tw>

DATA SHEET

PART NO. : L-C150QRCT

REV :     A / 1    

CUSTOMER'S APPROVAL : \_\_\_\_\_

DCC : \_\_\_\_\_

DRAWING NO. : DS-71-13-0012

DATE : 2016-6-24 PAGE

1 of 14

● PACKAGE OUTLINE DIMENSIONS

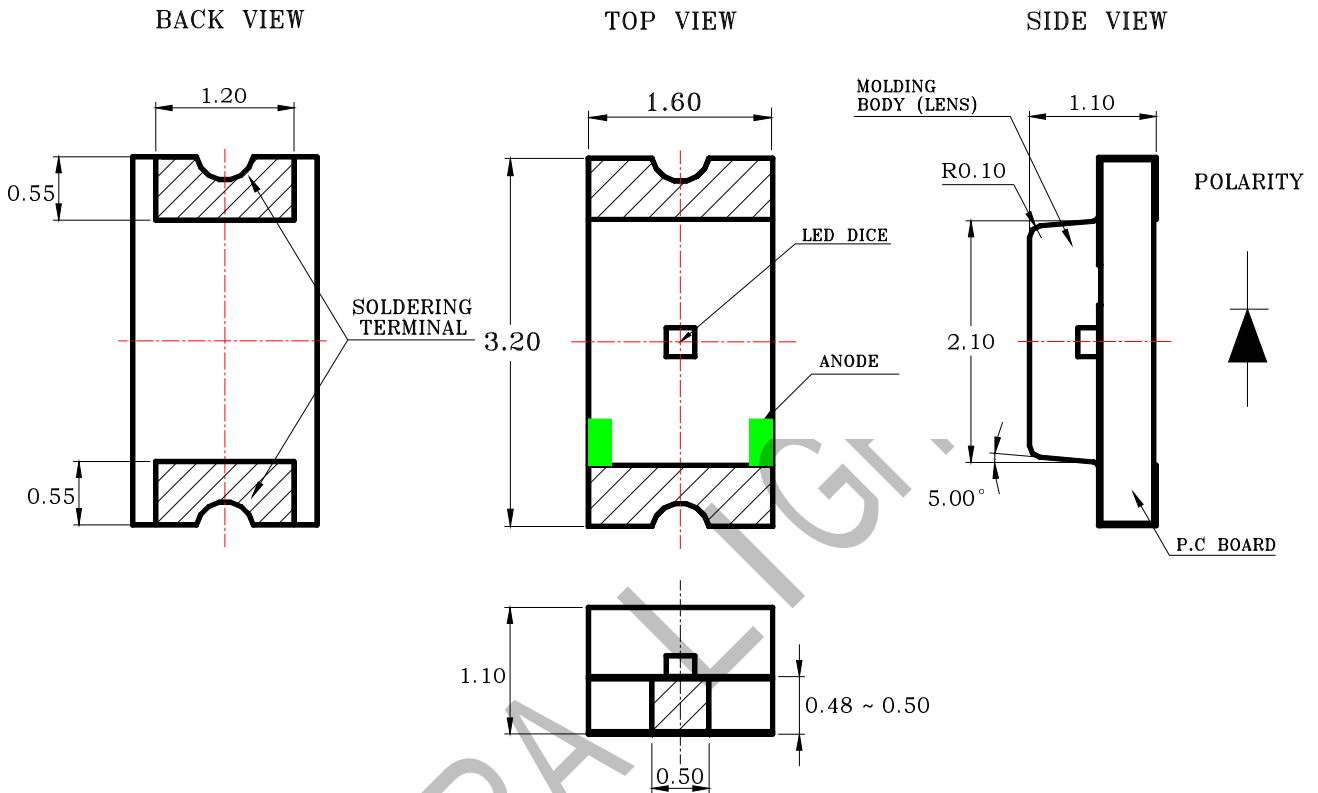

Notes:

1. All dimensions are in millimeters.
2. Tolerance is  $\pm 0.1\text{mm}$  (.004") unless otherwise noted.

● Features

- \* Top view, wide view angle, single color Chip LED.
- \* Package in 8mm tape on 7" diameter reels.
- \* Compatible with automatic Pick & Place equipment.
- \* Compatible with Infrared and Wave soldering reflow solder processes.
- \* EIA STD package.
- \* I.C. compatible.
- \* Pb free product.
- \* Meet RoHS Green Product.

● **Chip Materials**

- \* Dice Material : AlInGaP
- \* Light Color : Super Red
- \* Lens Color : Water Clear

● **Absolute Maximum Ratings(Ta=25°C)**

Symbol	Parameter	Rating	Unit
PD	Power Dissipation	75	mW
IPF	Peak Forward Current (1/10 Duty Cycle, 0.1ms Pulse Width)	80	mA
IF	Continuous Forward Current	30	mA
-	De-rating Linear From 25°C	0.25	mA/°C
VR	Reverse Voltage	5	V
ESD	Electrostatic Discharge Threshold(HBM)Note A	2000	V
Topr	Operating Temperature Range	-40 ~ +85	°C
Tstg	Storage Temperature Range	-40 ~ +85	°C

Note A :

HBM : Human Body Model. Seller gives no other assurances regarding the ability of to withstand ESD.

● **Electro-Optical Characteristics(Ta=25°C)**

Parameter	Symbol	Min.	Typ.	Max.	Unit	Test Condition
Luminous Intensity	IV	355	440		mcd	IF=20mA
Viewing Angle	2 θ 1/2		130		deg	Note 2
Peak Emission Wavelength	λ p		630		nm	Measurement @Peak
Dominant Wavelength	λ d		620		nm	IF=20mA
Spectral Line Half-Width	Δ λ		17		nm	
Forward Voltage	VF		2.0	2.3	V	IF =20mA
Reverse Current	IR			10	μ A	VR = 5V

● Bin Code List

Luminous Intensity(IV), Unit:mcd@20mA		
Bin Code	Min	Max
T2	355	450
U1	450	560

Tolerance of each bin are  $\pm 15\%$

Notes:

1. Luminous intensity is measured with a light sensor and filter combination that proximities the CIE eye-response curve.
2.  $\theta 1/2$  is the off-axis angle at which the luminous intensity is half the axial luminous intensity.
3. The dominant wavelength  $\lambda d$  is derived from the CIE chromaticity diagram and represents the single wavelength which defines the color of the device.
4. Caution in ESD :  
Static Electricity and surge damages the LED. It is recommended use a wrist band or anti-electrostatic glove when handling the LED. All devices, equipment and machinery must be properly grounded.
5. Major standard testing equipment by "Instrument System" Model : CAS140B Compact Array Spectrometer and "KEITHLEY" Source Meter Model : 2400.

### ● Typical Electro-Optical Characteristics Curves

(25°C Ambient Temperature Unless Otherwise Noted)

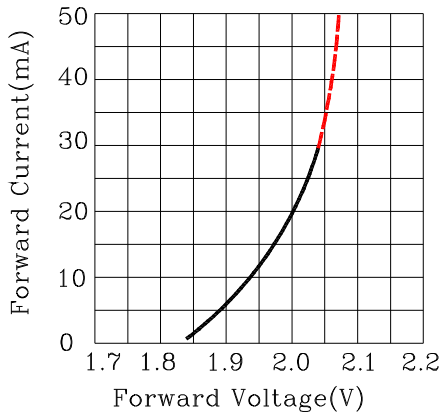

Fig.2 Forward Current vs. Forward Voltage

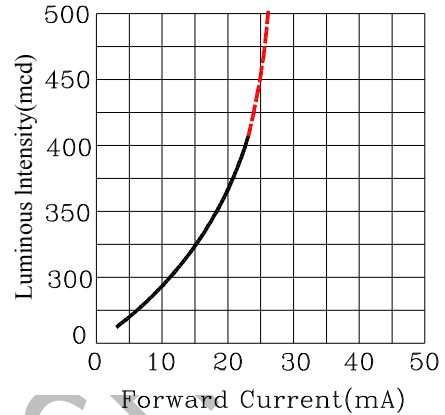

Fig.3 Luminous Intensity vs. Forward Current

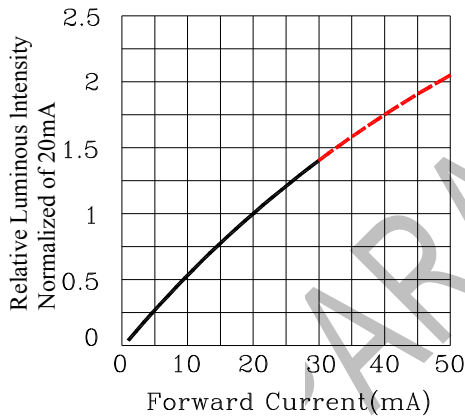

Fig.4 Relative Luminous Intensity vs. Forward Current

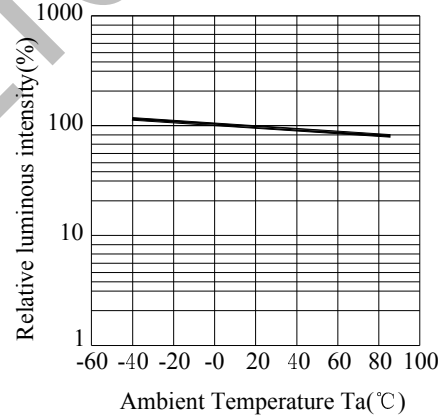

Fig.5 Luminous Intensity vs. Ambient Temperature

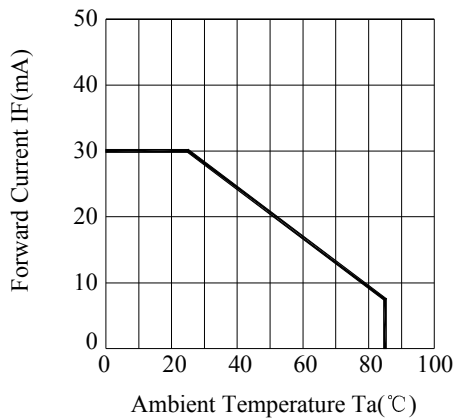

Fig.6 Forward Current Derating Curve

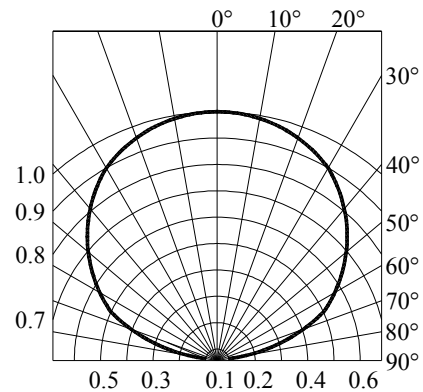

Fig.7 Relative Intensity vs. Angle



# SURFACE MOUNT DEVICE LED

Part No. : L-C150QRCT

REV:A / 1

## ● Label Explanation



ITEM CODE: PARRA LIGHT

PART NO: L-C150QRCT

IV --- Luminous Intensity Code

LOT NO:	<u>EM</u>	<u>S</u>	<u>L</u>	<u>12</u>	<u>09</u>	<u>0110</u>
	A	B	C	D	E	F

A---EM: Emos Code

B---S:SMD

L---Local

D---Year

E---Month

F---SPEC.

PACKING QUANTITY OF BAG :

3000pcs for 150、170、110、155、115 series

4000pcs for 191 series

5000pcs for 192 series

DATE CODE:	<u>2012</u>	<u>09</u>	<u>10</u>
	G	H	I

G--- Year

H--- Month

I --- Day

● Typical Electro-Optical Characteristics Curves

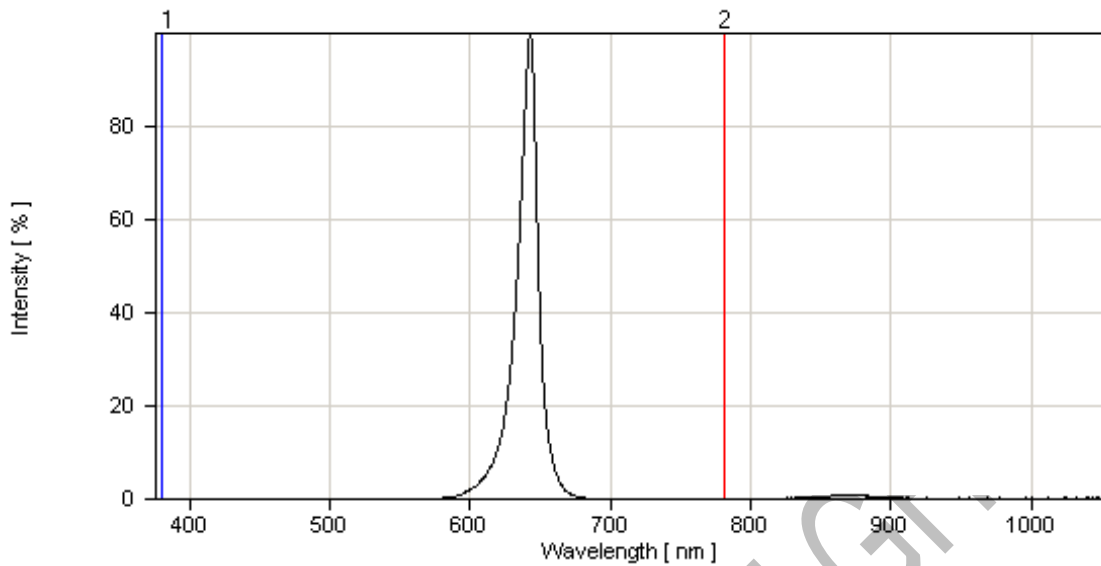
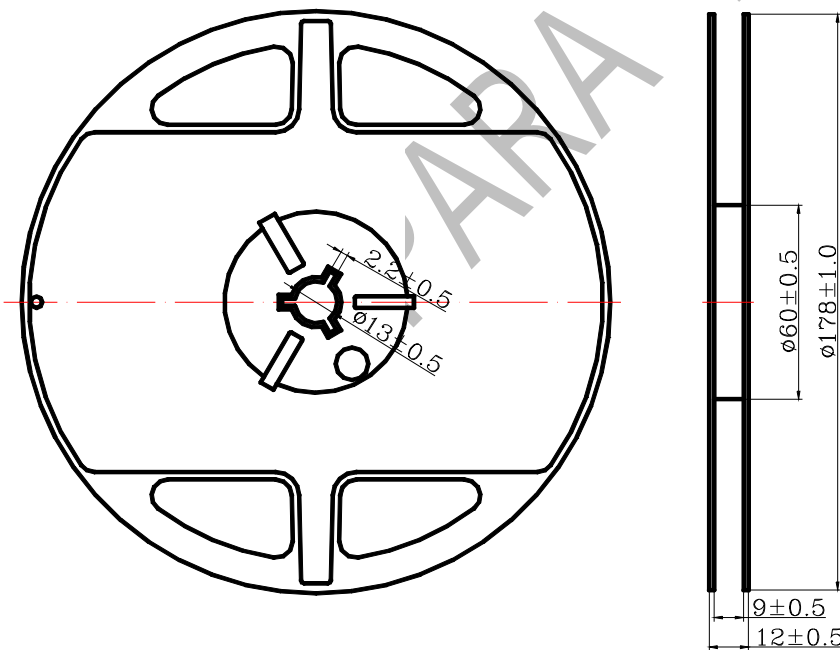

Fig.1 Relative Intensity vs. Wavelength

● Reel Dimensions



Notes:

1. Taping Quantity : 3000pcs
2. The tolerances unless mentioned is  $\pm 0.1\text{mm}$ , Angle  $\pm 0.5^\circ$  , Unit : mm.

● Package Dimensions Of Tape And Reel

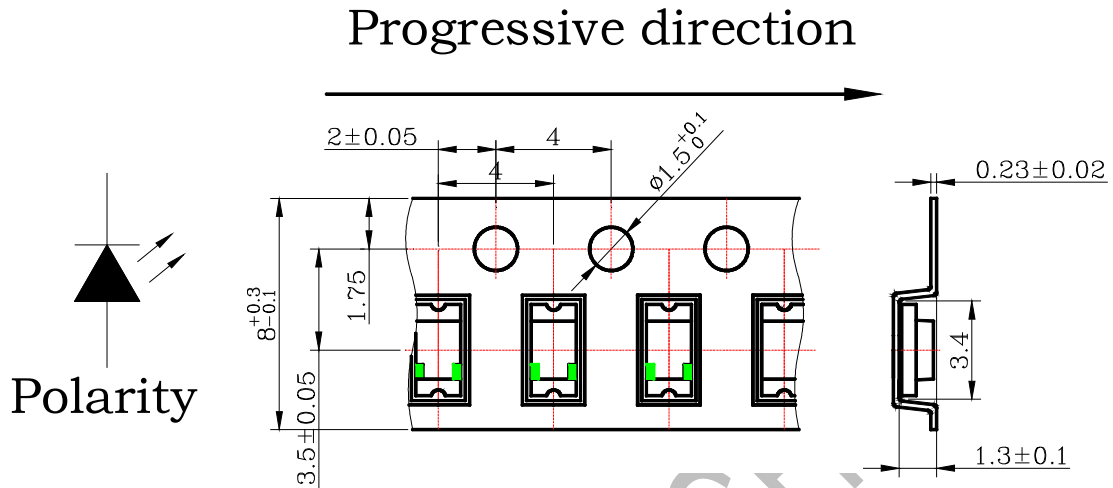

Notes: All dimensions are in millimeters.

Moisture Resistant Packaging

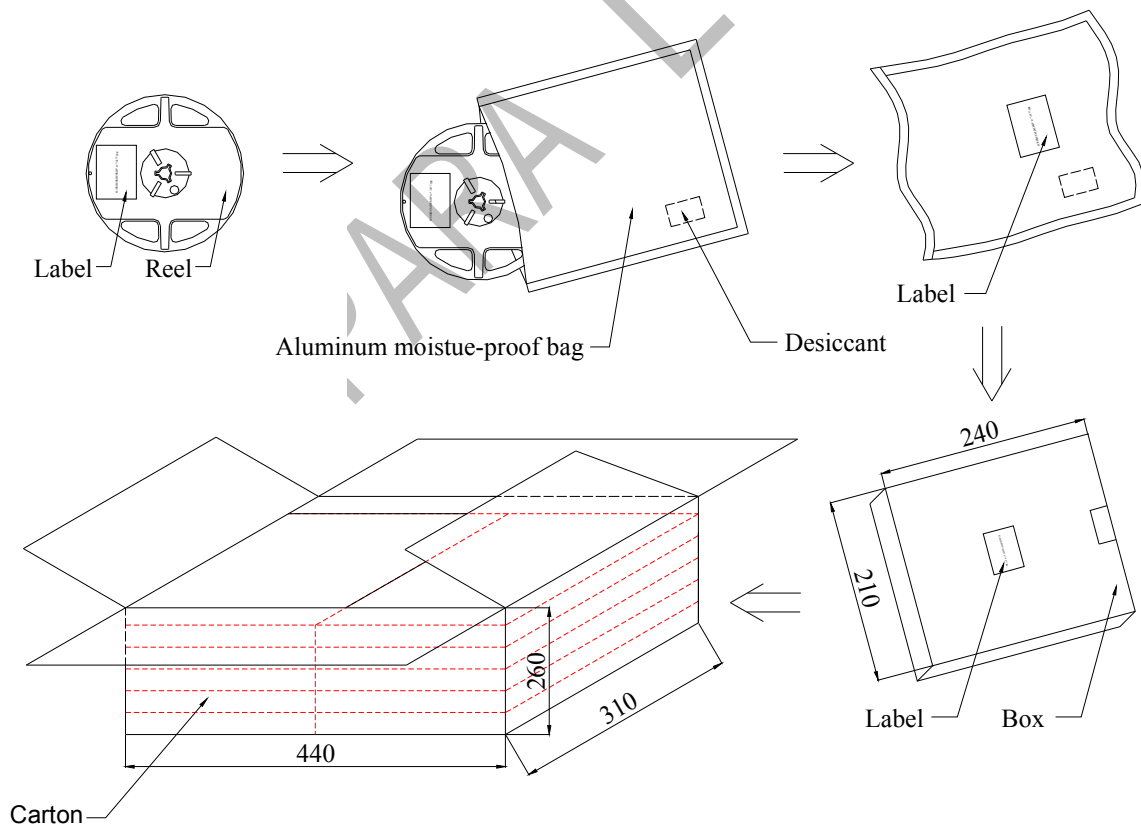

Notes : One reel in a bag, six bag in a inner box, six inner boxes in a carton. Unit : mm.



**● Cleaning**

- \* If cleaning is required , use the following solutions for less than 1 minute and less than 40°C.
- \* Appropriate chemicals: Ethyl alcohol and isopropyl alcohol.
- \* Effect of ultrasonic cleaning on the LED resin body differs depending on such factors as the oscillator output, size of PCB and LED mounting method. The use of ultrasonic cleaning should be enforced at proper output after confirming there is no problem.

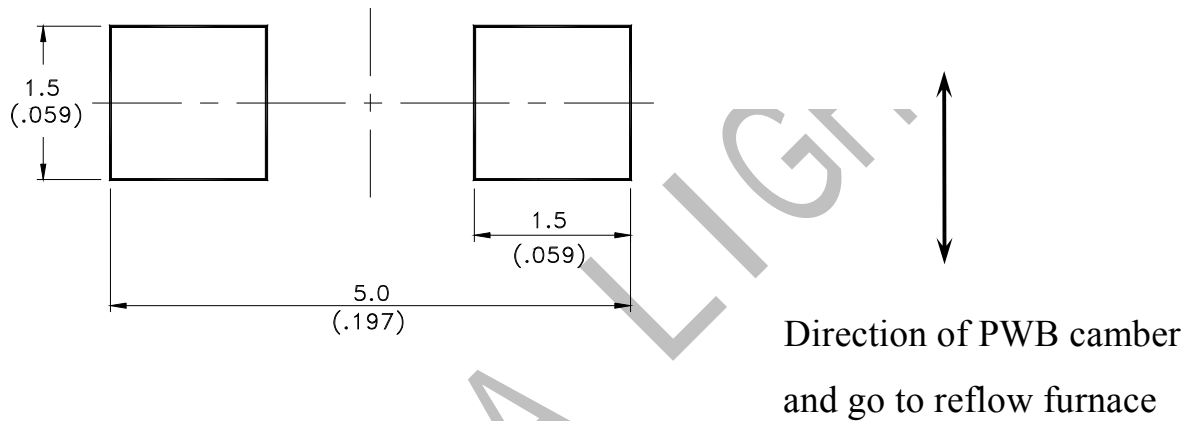
**● Suggest Soldering Pad Dimensions**

● Suggest Sn/Pb IR Reflow Soldering Profile Condition:

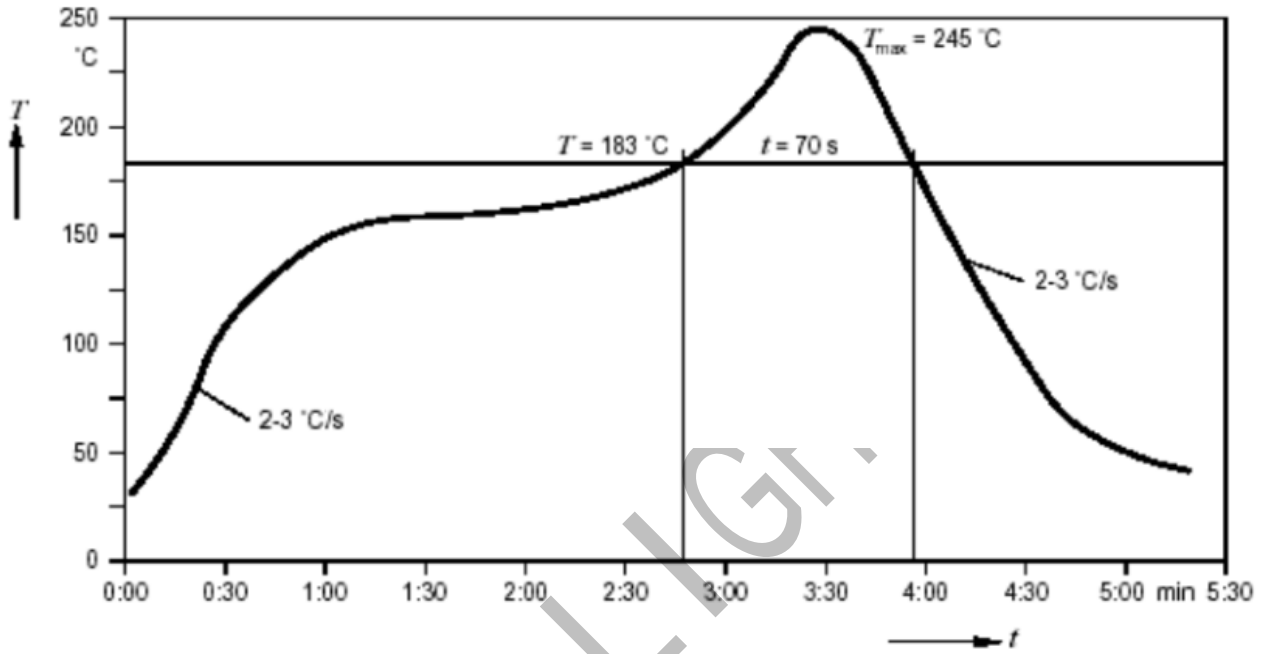

● Suggest Pb-Free IR Reflow Soldering Profile Condition:

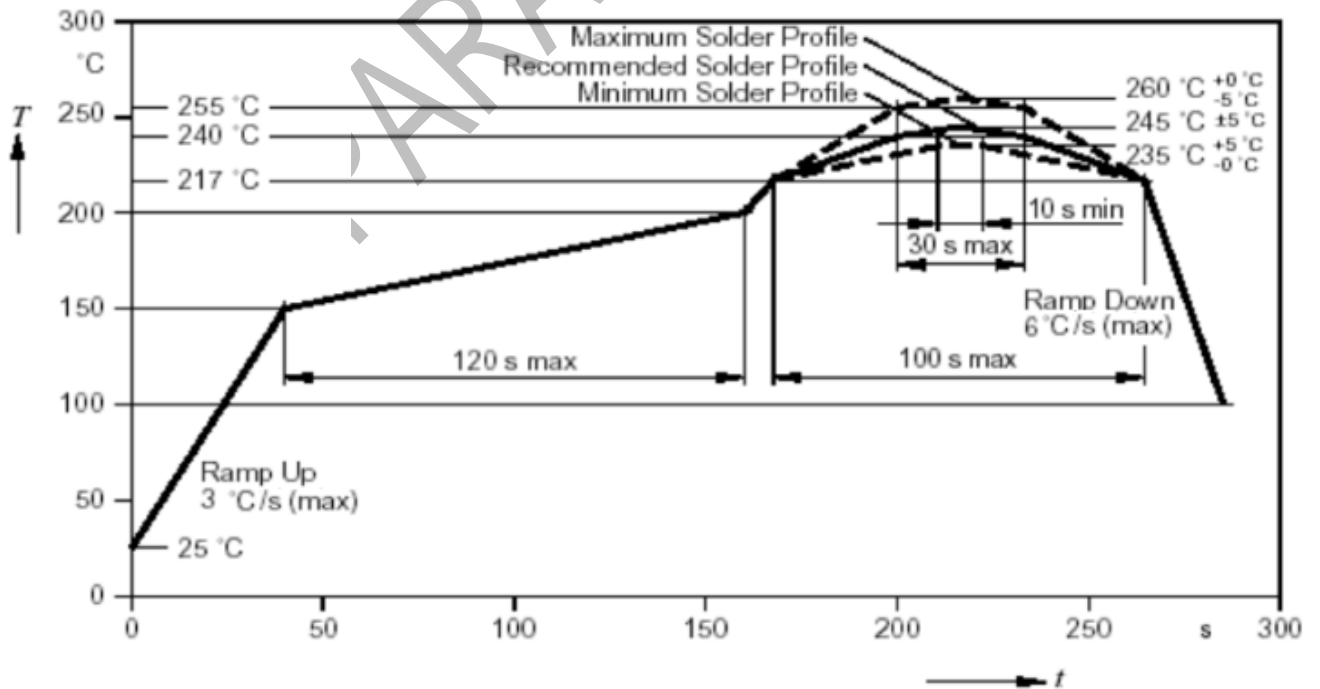

## ● CAUTIONS

### 1. Application Limitation :

The LED's described here are intended to be used for ordinary electronic equipment (such as office equipment, communication equipment and household application). Consult PARA's sales in advance for information on application in which exceptional quality and reliability are required, particularly when the failure or malfunction of the LED's may directly jeopardize life or health (such as airplanes, automobiles, traffic control equipment, life support system and safety devices).

### 2. Storage :

Do not open moisture proof bag before the products are ready to use.

Before opening the package: The LEDs should be kept at 30°C or less and 90%RH or less.

After opening the package: The LED's floor life is 1 year under 30°C or less and 60% RH or less. If unused LEDs remain, it should be stored in moisture proof packages.

If the moisture absorbent material (silica gel) has faded away or the LEDs have exceeded the storage time, baking treatment should be performed using the following conditions.

Baking treatment: 60±5°C for 24 hours.

### 3. Soldering

Do not apply any stress to the lead frame during soldering while the LED is at high temperature.

Recommended soldering condition.

Reflow Soldering :

Pre-heat 120~150°C, 120sec. MAX., Peak temperature : 240°C Max. Soldering time : 10 sec Max.

Soldering Iron : (Not recommended)

Temperature 300°C Max., Soldering time : 3 sec. Max.(one time only), power dissipation of iron : 20W Max. use SN60 solder of solder with silver content and don't to touch LED lens when soldering.

Wave soldering :

Pre-heat 100°C Max, Pre-heat time 60 sec. Max, Solder wave 260°C Max, Soldering time 5 sec. Max. preformed consecutively cooling process is required between 1<sup>st</sup> and 2<sup>nd</sup> soldering processes.

4. Lead-Free Soldering

For Reflow Soldering :

- 1、Pre-Heat Temp:150-180°C,120sec.Max.
- 2、Soldering Temp:Temperature Of Soldering Pot Over 230°C,40sec.Max.
- 3、Peak Temperature:260°C , 5sec.
- 4、Reflow Repetition:2 Times Max.
- 5、Suggest Solder Paste Formula 93.3 Sn/3.1 Ag/3.1 Bi /0.5 Cu

For Soldering Iron (Not Recommended) :

- 1、Iron Tip Temp:350°C Max.
- 2、Soldering Iron:30w Max.
- 3、Soldering Time:3 Sec. Max. One Time.

For Dip Soldering :

- 1、Pre-Heat Temp:150°C Max. 120 Sec. Max.
- 2、Bath Temp:265°C Max.
- 3、Dip Time:5 Sec. Max.

5. Drive Method

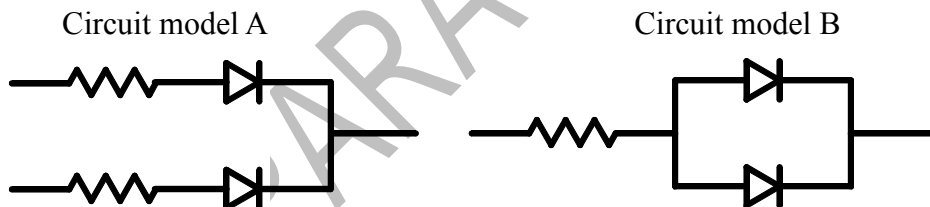

(A)Recommended circuit.

(B)The difference of brightness between LED`s could be found due to the Vf-If characteristics of LED.



# SURFACE MOUNT DEVICE LED

Part No. : L-C150QRCT

REV:A / 1

## 6. Reliability Test

Classification	Test Item	Test Condition	Reference Standard
Endurance Test	Operation Life	Ta= Under Room Temperature As Per Data Sheet Maximum Rating *Test Time= 1000HRS (-24HRS,+72HRS)*@20mA.	MIL-STD-750D:1026 (1995) MIL-STD-883D:1005 (1991) JIS C 7021:B-1 (1982)
	High Temperature High Humidity Storage	IR-Reflow In-Board, 2 Times Ta= 65±5°C, RH= 90~95% *Test Time= 1000HRS±2HRS	MIL-STD-202F:103B(1980) JIS C 7021:B-11(1982)
	High Temperature Storage	Ta= 105±5°C Test Time= 1000HRS (-24HRS,72HRS)	MIL-STD-883D:1008 (1991) JIS C 7021:B-10 (1982)
	Low Temperature Storage	Ta= -55±5°C *Test Time=1000HRS (-24HRS,72HRS)	JIS C 7021:B-12 (1982)
Environmental Test	Temperature Cycling	105±5°C      -55±5°C 10mins      10mins      100 Cycles	MIL-STD-202F:107D (1980) MIL-STD-750D:1051(1995) MIL-STD-883D:1010 (1991) JIS C 7021:A-4(1982)
	Thermal Shock	IR-Reflow In-Board, 2 Times 105±5°C      -55°C±5°C 10mins      10mins      100 Cycles	MIL-STD-202F:107D(1980) MIL-STD-750D:1051(1995) MIL-STD-883D:1011 (1991)
	Solder Resistance	Tsol= 260 ± 5°C Dwell Time= 10 ± 1sec	MIL-STD-202F:210A(1980) MIL-STD-750D:2031(1995) JIS C 7021:A-1(1982)
	Solder ability	Tsol= 235 ± 5°C Immersion time 2±0.5 sec Immersion rate 25±2.5 mm/sec Coverage ≥95% of the dipped surface	MIL-STD-202F:208D(1980) MIL-STD-750D:2026(1995) MIL-STD-883D:2003(1991) IEC 68 Part 2-20 JIS C 7021:A-2(1982)

## 7. Others:

The appearance and specifications of the product may be modified for improvement without notice.

● PART NO. SYSTEM :

L - C 1 5 0 X C X X - X X X X

**XXXX** : Special specification for customer

**T** : Taping for 7 inch reel  
**TC** : Taping for 13 inch reel  
**TH** : IV half binning  
**TP** : Wavelength binning

**Lens color**  
**C** : Water Clear  
**W** : White Diffused  
**T** : Color Transparent  
**D** : Color Diffused

**G** : Gap 570nm Green  
**Y** : GaAsp 585 nm Yellow  
**E** : GaAsp 620 nm Orange  
**QR** : GaAlAs 630 nm Red  
**KG** : AllnGap 570nm Super Green  
**KY** : AllnGap 590nm Super Yellow  
**KF** : AllnGap 605nm Super Amber  
**KR** : AllnGap 630 nm Super Red  
**LB** : InGaN 470nm Blue  
**LG** : InGaN 525nm Green.....

**0** : Single chip  
**1/2** : Super thin single chip  
**5/6** : Dual chip  
**F** : Three chip(Full color)

**150** : 1206 1.1T Type  
**170** : 0805 0.8T Type  
**191** : 0603 0.6T Type  
**192** : 0603 0.4T Type  
**110** : 1206 1.0T Type

**C** : Top View Type  
**S** : Side View Type

# 履 历 表

文件编号		DS-71-13-0012	文件名称	L-C150QRCT	页次：1	
版次	修改日期	变 更 内 容 说 明			生效日期	核准人
A/0	2013.11.22	新建				
A/1	2016.06.24	1.修正外箱尺寸				

## X-ON Electronics

Largest Supplier of Electrical and Electronic Components

*Click to view similar products for [Standard LEDs - SMD category](#):*

*Click to view products by [Para Light manufacturer](#):*

Other Similar products are found below :

[LTST-C190KYKT](#) [LTST-C19GD2WT](#) [LTST-N683GBEW](#) [LTW-170ZDC](#) [LTW-M140SZS40](#) [LTW-M140ZVS](#) [598-8110-100F](#) [598-8170-100F](#) [598-8610-202F](#) [AAAF5060QBFSEEZGS](#) [ALMD-LB36-SV002](#) [APT1608QGWW](#) [EAST2012YA0](#) [EASV1803BA0](#) [SML-512VWT86A](#) [SML-LX0606SISUGC/A](#) [SML-LXL1307SRC-TR](#) [SML-LXR851SIUPGUBC](#) [LT1ED53A](#) [AM27ZGC03](#) [APB3025SGNC](#) [APFA3010SURKCGKQBDC](#) [APHK1608VGCA](#) [APT2012QGWW](#) [CLX6D-FKB-CN1R1H1BB7D3D3](#) [LTST-008BGEW](#) [LTW-020ZDCG](#) [LTW-21TS5](#) [LTW-220DS5](#) [598-8330-117F](#) [SML-LX0402IC-TR](#) [CMDA20AYAA7D1S](#) [CMDA16AYDR7A1X](#) [91-21SYGD/S530-E2/TR7](#) [598-8040-100F](#) [598-8070-100F](#) [598-8140-100F](#) [598-8610-200F](#) [EAST2012GA0](#) [EAPL3527GA5](#) [SML-LXL1209SYC/ATR](#) [EAST2012RA0](#) [CMD91-21VRC/TR7](#) [SML-LXR851SGSIC-TR](#) [SML-512PWT86A](#) [SMF-2432GYC-TR](#) [LTST-C194TBKT-5A](#) [CLX6E-FKC-CH1M1D1BB7C3D3](#) [SML-LXL0805USBC-TR](#) [SML-LX2835SYSUGCTR](#)