



PARA LIGHT ELECTRONICS CO., LTD.

11F, No.8, Jiankang Rd,Zhonghe Dist,New Taipei City 253, Taiwan

Tel: 886-2-2225-3733 Fax: 886-2-2225-4800

E-mail: para@para.com.tw [http:// www.paralighttaiwan.com](http://www.paralighttaiwan.com)

DATA SHEET

PART NO. : L-C175JRJGCT-AM

REV : A / 1

CUSTOMER'S APPROVAL : _____ DCC : _____



2.0*1.25*1.1 mm SMD LED

L-C175JRJGCT-AM

REV:A / 1

PACKAGE DIMENSIONS

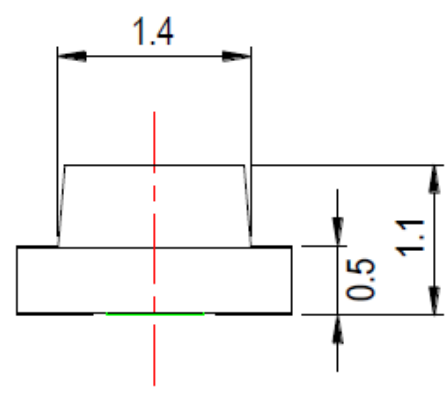
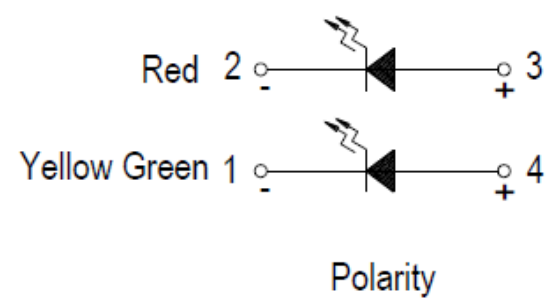
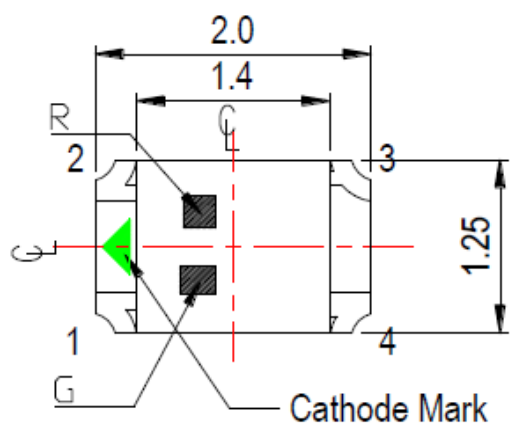

Recommended Solder Pad

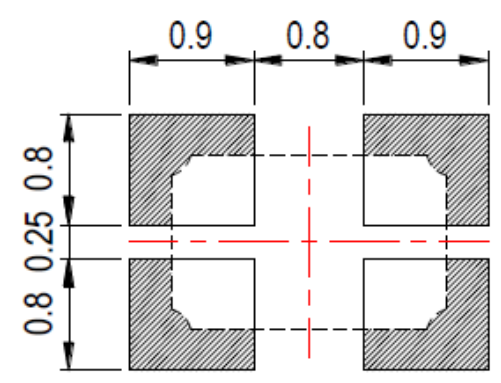
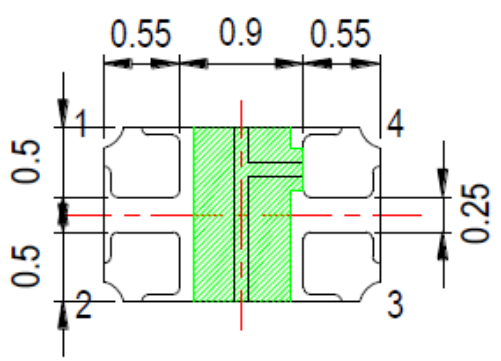

Note:
Tolerance unless mentioned is ± 0.1 mm, Unit = mm.



2.0*1.25*1.1 mm SMD LED

L-C175JRJGCT-AM

REV:A / 1

FEATURES

- * LOW POWER CONSUMPTION
- * I.C. COMPATIBLE
- * LONGLIFE SOLID STATE RELIABILITY

CHIP MATERIALS

- * Dice Material : AlInGaP / AlInGaP
- * Light Color : Brilliant Red & Brilliant Yellow Green
- * Lens Color : WATER CLEAR

ABSOLUTE MAXIMUM RATING : (Ta = 25°C)

SYMBOL	PARAMETER	RATING		UNIT
		Red	Green	
PD	Power Dissipation	60	60	mW
If	Forward Current	25	25	mA
Ifp	Peak Forward Current (1/10 duty cycle 0.1ms)	60	60	mA
VR	Reverse Voltage	5		V
ESD	Electrostatic Discharge Threshold(HBM)	2000	2000	V
Topr	Operating Temperature Range	-40 ~ + 85		°C
Tstg	Storage Temperature Range	-40 ~ + 100		°C
Tsld	Soldering Temperature	Reflow Soldering : 260 °C for 10 sec Hand Soldering : 350 °C for 3 sec		

ELECTRO-OPTICAL CHARACTERISTICS : (Ta = 25°C)

SYMBOL	PARAMETER	TEST CONDITION	VALUE			UNIT
			MIN.	TYP.	MAX.	
VF	Forward Voltage	IF = 5mA	Red	1.6	2.1	V
			Green	1.6	2.1	
IR	Reverse Current	VR = 5V			10	µA
Δλ	Spectral Line Half-Width	IF = 5mA		20		nm
λp	Peak Emission Wavelength	IF = 5mA	Red	632		nm
			Green		575	
λD	Dominant Wavelength	IF = 5mA	Red	617.5	625.5	nm
			Green	567.5	575.5	
2θ1/2	Half Intensity Angle	IF = 5mA		130		deg
Iv	Luminous Intensity	IF = 5mA	Red	11.5	45	mcd
			Green	7.2	18	



2.0*1.25*1.1 mm SMD LED

L-C175JRJGCT-AM

REV:A / 1

Typical Electro-Optical Characteristics Curves
(25°C Ambient Temperature Unless Otherwise Noted)

Brilliant Red:

Fig.1-Forward Voltage Shift vs. Junction Temperature

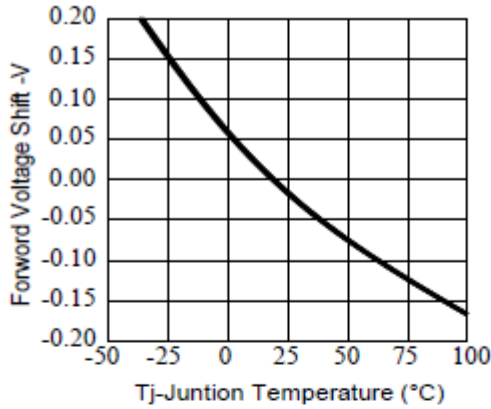

Fig.2-Relative Luminous Intensity vs. Forward Current $T_s=25^\circ\text{C}$

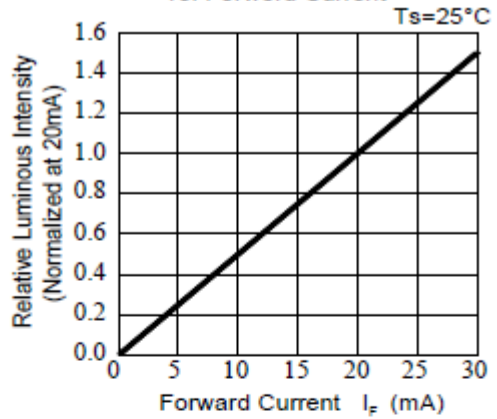

Fig.3-Relative Luminous Intensity vs. Junction Temperature

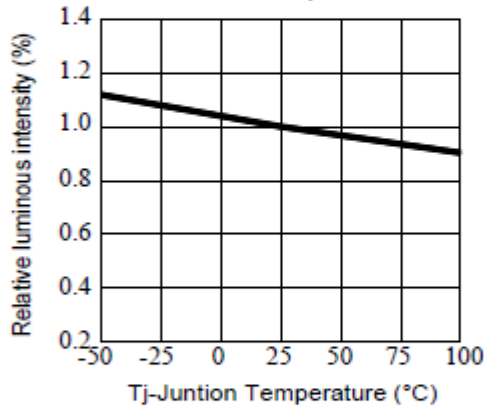

Fig.4-Forward Current vs. Forward Voltage $T_a=25^\circ\text{C}$

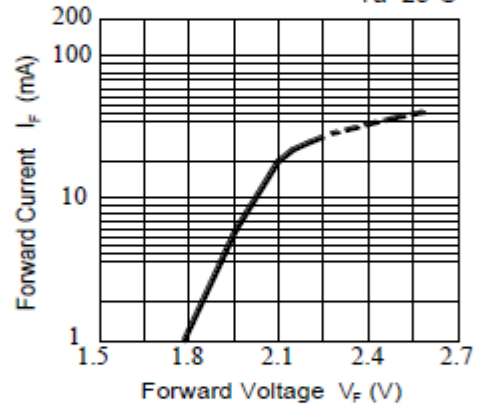

Fig.5-Max. Driving Forward Current vs. Soldering Temperature

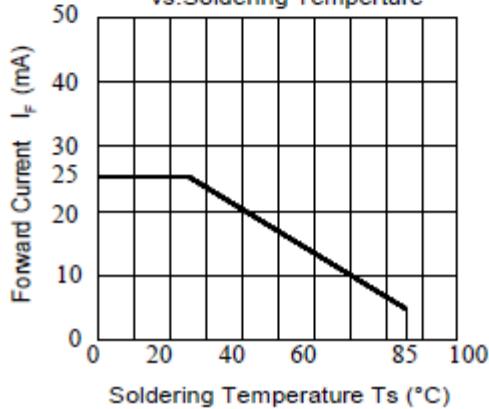
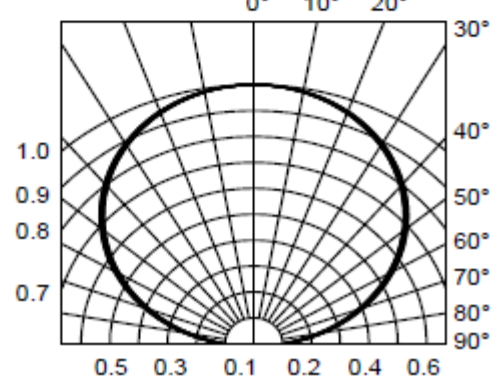

Fig.6-Radiation Diagram $T_a=25^\circ\text{C}$





2.0*1.25*1.1 mm SMD LED

L-C175JRJGCT-AM

REV:A / 1

Typical Electro-Optical Characteristics Curves (25°C Ambient Temperature Unless Otherwise Noted)

Brilliant Yellow Green:

Fig.1-Forward Voltage Shift vs. Junction Temperature

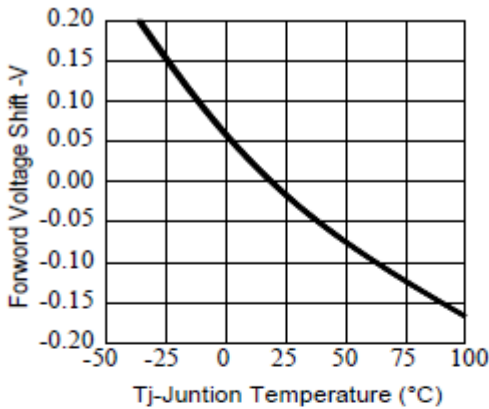

Fig.2-Relative Luminous Intensity vs. Forward Current $T_s=25^\circ\text{C}$

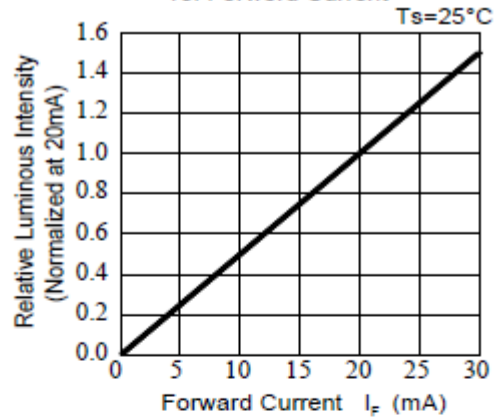

Fig.3-Relative Luminous Intensity vs. Junction Temperature

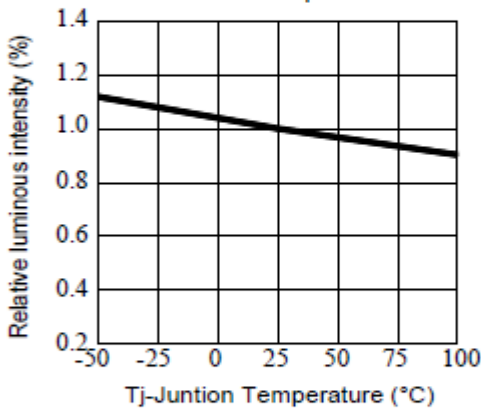

Fig.4-Forward Current vs. Forward Voltage $T_a=25^\circ\text{C}$

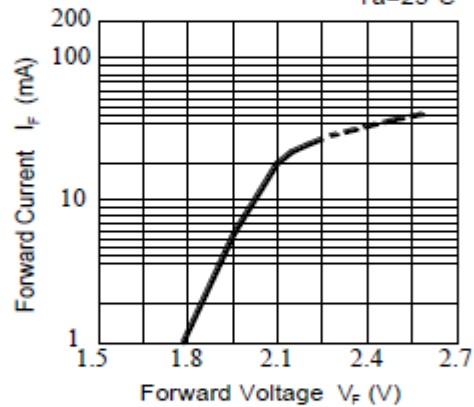

Fig.5-Max. Driving Forward Current vs. Soldering Temperature

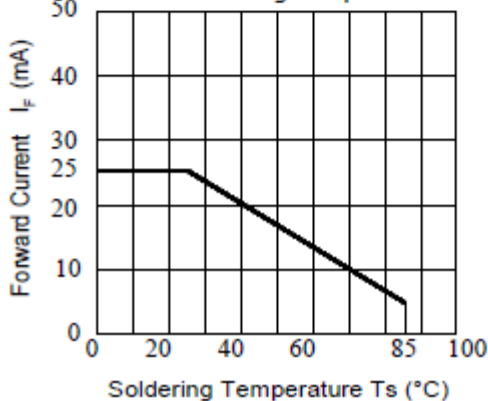
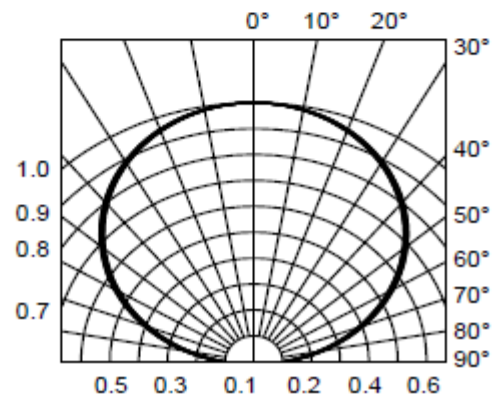

Fig.6-Radiation Diagram $T_a=25^\circ\text{C}$





2.0*1.25*1.1 mm SMD LED

L-C175JRJGCT-AM

REV:A / 1

Bin Range of Luminous Intensity(Brilliant Red)

Bin Code	Min.	Max.	Unit	Condition
AL	11.5	18.0	mcd	I _F =5mA
AM	18.0	28.5		
AN	28.5	45.0		

Bin Range of Luminous Intensity(Brilliant Yellow Green)

Bin Code	Min.	Max.	Unit	Condition
AK1	7.2	9.0	mcd	I _F =5mA
AK2	9.0	11.5		
AL1	11.5	14.5		
AL2	14.5	18.0		

Note: Tolerance of Luminous Intensity: ±10%

Bin Range of Dominant Wavelength(Brilliant Red)

Bin Code	Min.	Max.	Unit	Condition
R4	617.5	621.5	nm	I _F =5mA
R5	621.5	625.5		

Bin Range of Dominant Wavelength(Brilliant Yellow Green)

Bin Code	Min.	Max.	Unit	Condition
AG15	567.5	569.5	nm	I _F =5mA
AG16	569.5	571.5		
AG17	571.5	573.5		
AG18	573.5	575.5		

Note: Tolerance of Dominant Wavelength: ±1nm



2.0*1.25*1.1 mm SMD LED

L-C175JRJGCT-AM

REV:A / 1

Spectrum Distribution(Brilliant Red)

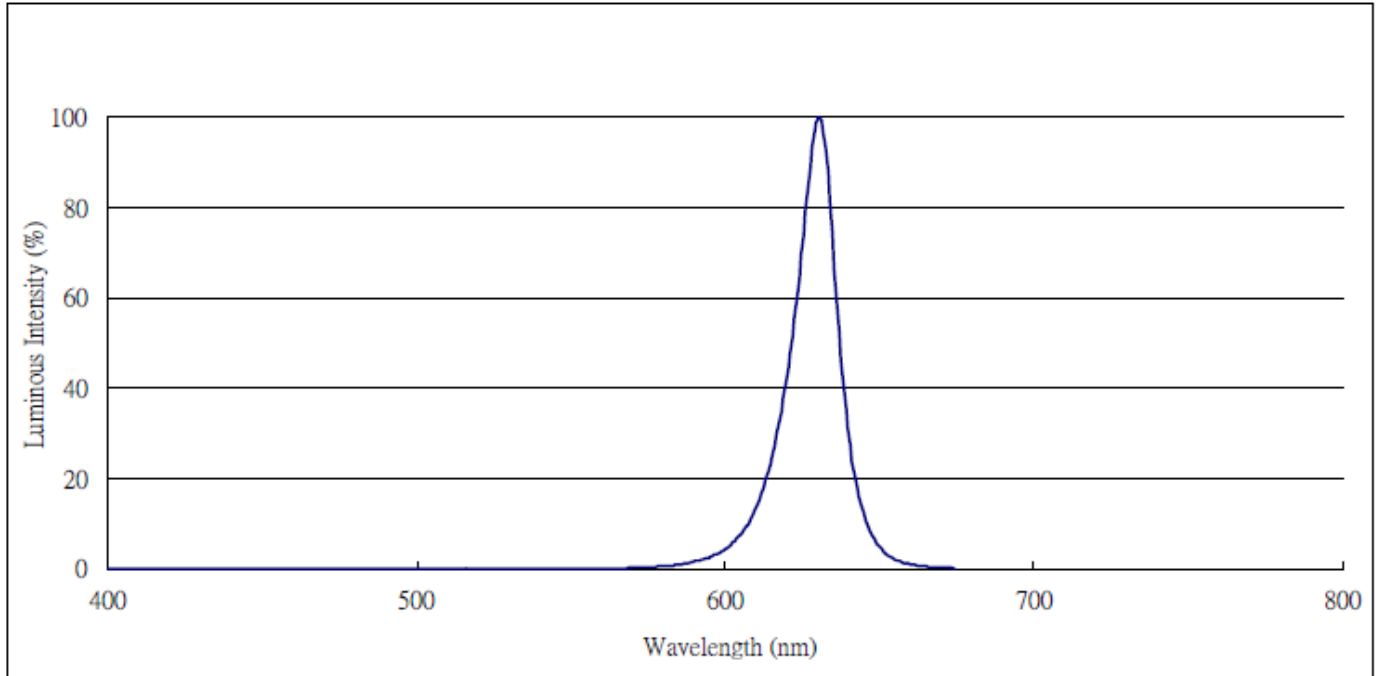

Spectrum Distribution(Brilliant Yellow Green)

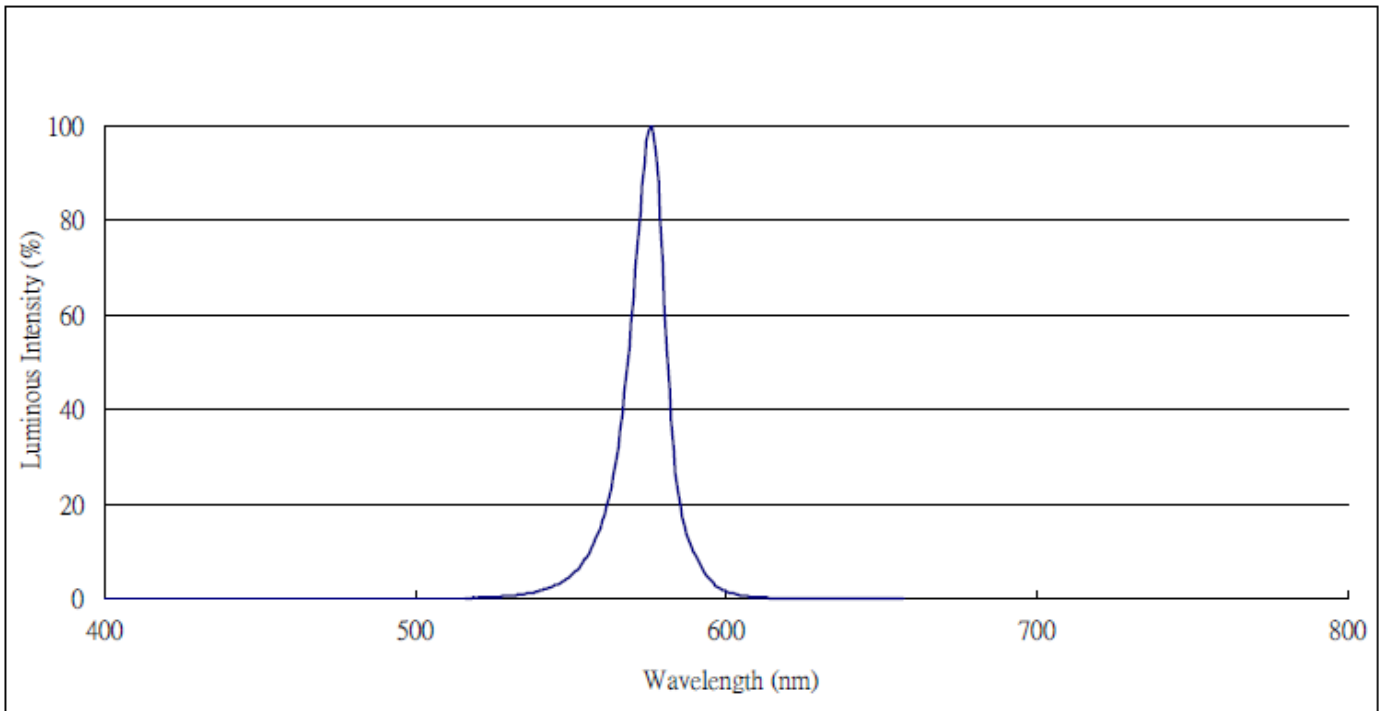



2.0*1.25*1.1 mm SMD LED

L-C175JRJGCT-AM

REV:A / 1

Reel Dimensions

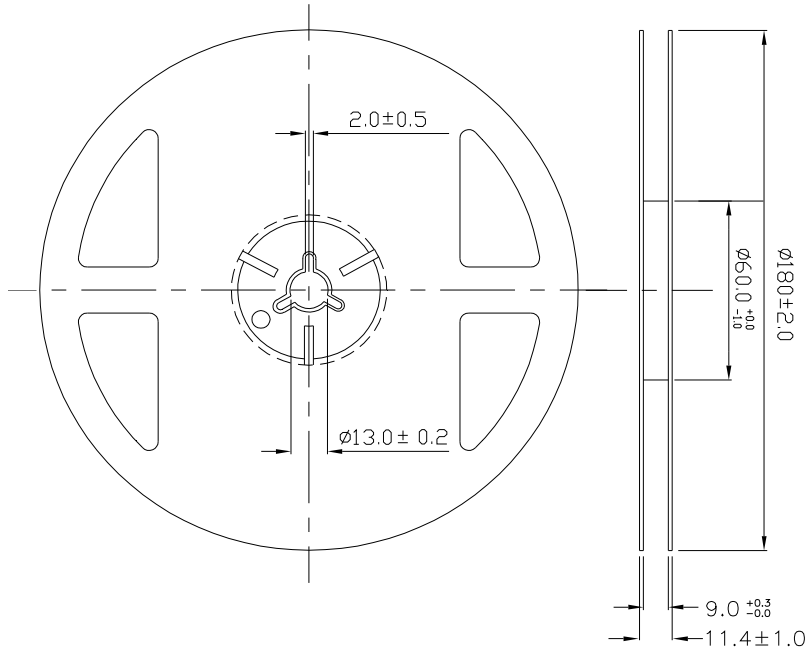

Note: Tolerances unless mentioned ± 0.1 mm, Unit = mm.

Carrier Tape Dimensions: Loaded Quantity 3000 pcs Per Reel

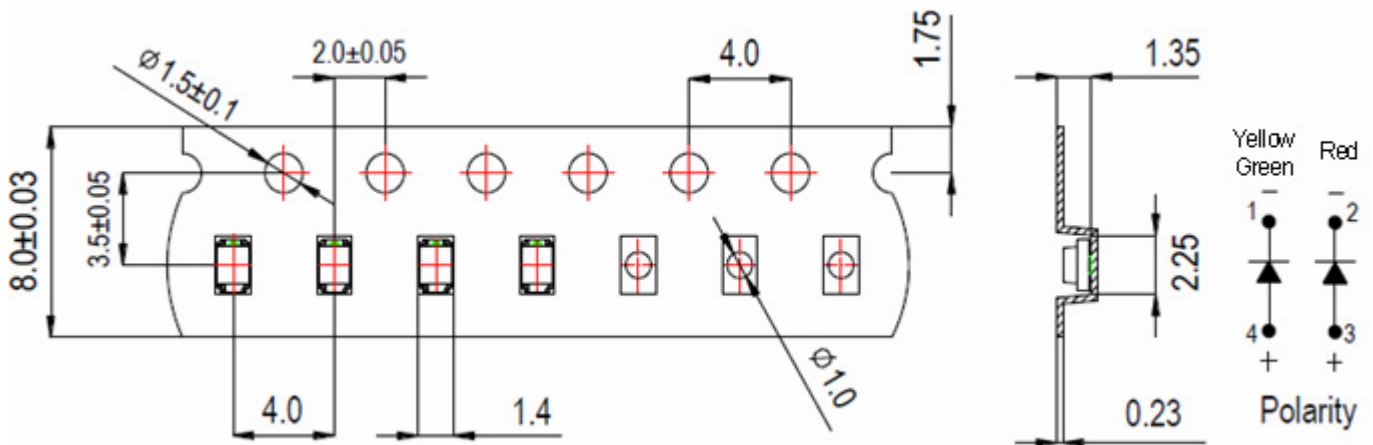

Note:

1. Tolerance unless mentioned is ± 0.1 mm, Unit = mm.
2. Minimum packing amount is 1000/2000 pcs per reel.



2.0*1.25*1.1 mm SMD LED

L-C175JRJGCT-AM

REV:A / 1

Moisture Resistant Packing Process

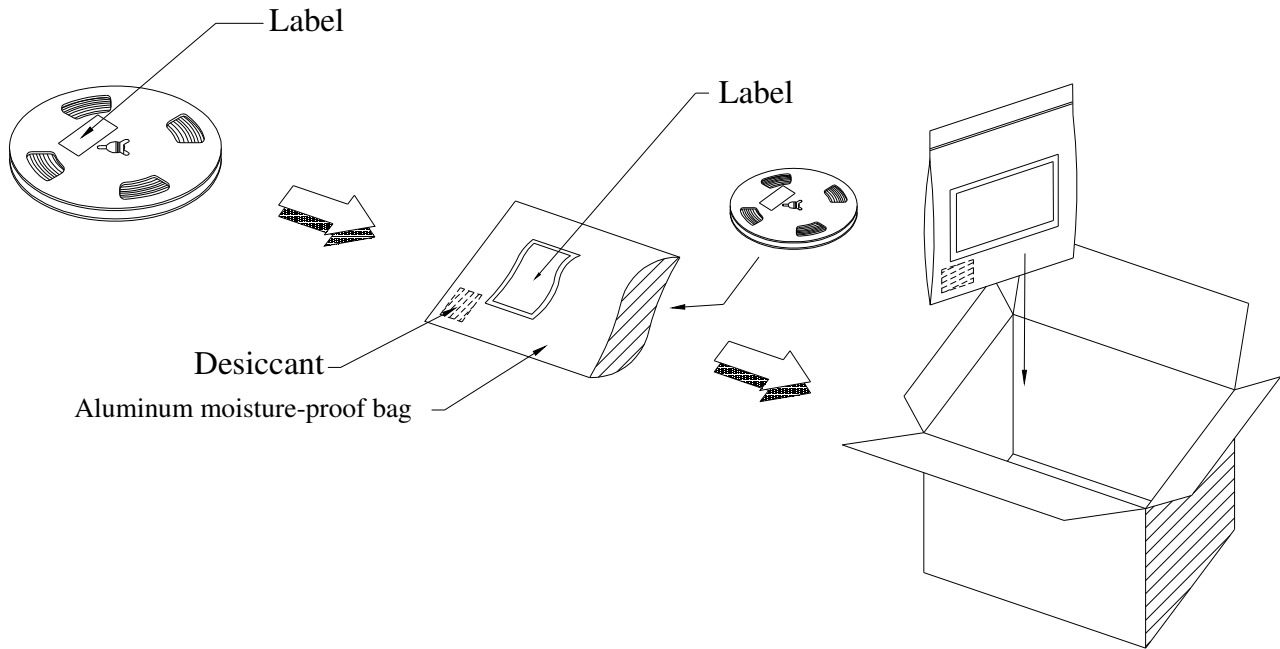

Reliability Test Items and Conditions

The reliability of products shall be satisfied with items listed below.

Confidence level : 90%

LTPD : 10%

No.	Items	Test Condition	Test Hours/Cycles	Sample Size	Ac/Re
1	Reflow Soldering	Temp. : 260°C/10sec.	6 Min.	22 PCS.	0/1
2	Thermal Shock	H : +100°C 5min ∩ 10 sec L : -10°C 5min	300 Cycles	22 PCS.	0/1
3	Temperature Cycle	H : +100°C 15min ∩ 5 min L : -40°C 15min	300 Cycles	22 PCS.	0/1
4	High Temperature/Humidity Reverse Bias	Ta=85°C,85%RH	1000 Hrs.	22 PCS.	0/1
5	Low Temperature Storage	Ta=-40°C	1000 Hrs.	22 PCS.	0/1
6	High Temperature Storage	Ta=100°C	1000 Hrs.	22 PCS.	0/1
7	DC Operation Life	Ta=25°C, I _F = 20 mA	1000 Hrs.	22 PCS.	0/1



2.0*1.25*1.1 mm SMD LED

L-C175JRJGCT-AM

REV:A / 1

Precautions for Use

1. Over-current-proof

Customer must apply resistors for protection; otherwise slight voltage shift will cause big current change (Burn out will happen).

2. Storage

2.1 Do not open moisture proof bag before the products are ready to use.

2.2 Before opening the package: The LEDs should be kept at 30°C or less and 90%RH or less.

2.3 After opening the package: The LED's floor life is 1 year under 30°C or less and 60% RH or less. If unused LEDs remain, it should be stored in moisture proof packages.

2.4 If the moisture absorbent material (silica gel) has faded away or the LEDs have exceeded the storage time, baking treatment should be performed using the following conditions.

Baking treatment: 60±5°C for 24 hours.

3. Soldering Condition

3.1 Pb-free solder temperature profile

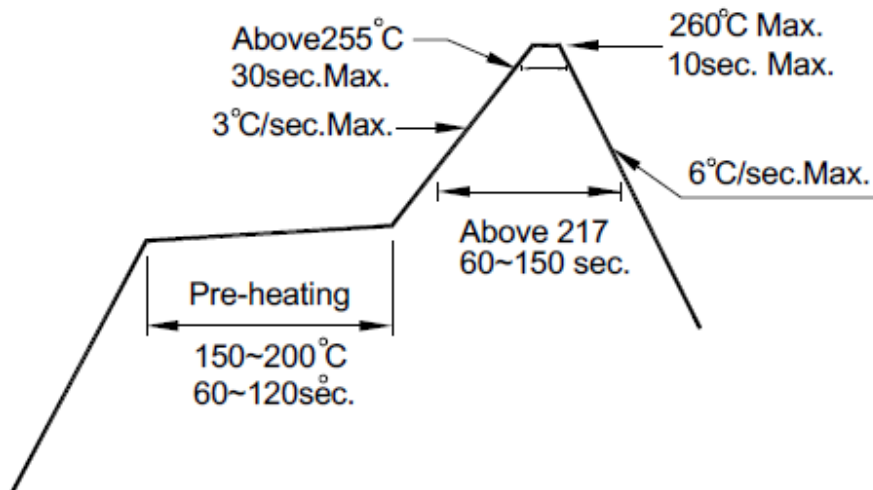

3.2 Reflow soldering should not be done more than two times.

3.3 When soldering, do not put stress on the LEDs during heating.

3.4 After soldering, do not warp the circuit board.

4. Soldering Iron

Each terminal is to go to the tip of soldering iron temperature less than 350°C for 3 seconds within once in less than the soldering iron capacity 25W. Leave two seconds and more intervals, and do soldering of each terminal. Be careful because the damage of the product is often started at the time of the hand solder.

5. Repairing

Repair should not be done after the LEDs have been soldered. When repairing is unavoidable, a double-head soldering iron should be used (as below figure). It should be confirmed beforehand whether the characteristics of the LEDs will or will not be damaged by repairing.

X-ON Electronics

Largest Supplier of Electrical and Electronic Components

Click to view similar products for [para light manufacturer](#):

Other Similar products are found below :

[UBL-3024-YW](#) [L-SC1R9PD1D1](#) [L3535UVC-K1PC](#) [LS115KRLGCT-20A](#) [L-C153PTDT-Lens-HD](#) [LT5050UVC-XPC](#) [B-1000G-GW](#) [L-C150WDT](#) [LT2835KYCT-BE1](#) [LS115JRJGCT-5A-UEI](#) [LT670KYCT](#) [L329EIR1C-UEI](#) [LT2835WDT-CW0-CM](#) [LC191IR1CT-HF](#) [L524EIR1C](#) [LC295JRLBCT](#) [LC195JRLBCT](#) [L-C170TBCT](#) [A-1001SRBW](#) [L-C175JRJGCT-AM](#) [L314EIR1C](#) [L-C150JRCT](#) [521110R1H-364-G](#) [LC191JGCT-5A](#) [L0001-4589](#) [L-C153CIR1CT-Lens-HD](#) [LT670LGCT](#) [LT670LBCT](#) [LC170WZDT](#) [LS110LGCT](#) [L-C292WDT-5A-YY](#) [L-513ED](#) [LS115JYLGCT](#) [L-C192CWDT-HM](#) [LS110LBCT](#) [LC195JYLGCT](#) [LC150JFCT](#) [LC195JGJYCT-GJ](#) [LC191JFCT-UEI](#) [LT2835IR1CT-150mA-HX](#) [LC295JYJGCT](#) [LC295KGGYCT](#) [L-C170JYCT](#) [L-5T47VB5C-D2-TR](#) [L-5T47LPG41C-D1](#) [L-513HURC](#)