



PARA LIGHT ELECTRONICS CO., LTD.

11F., No. 8, Jiankang Rd., Zhonghe Dist., New Taipei City 235, Taiwan,

Tel: 886-2-2225-3733

Fax: 886-2-2225-4800

E-mail: para@para.com.tw

www.paralighttaiwan.com

DATA SHEET

PART NO. : L-C295KGKYCT

REV : A/2

CUSTOMER'S APPROVAL : _____

DCC : _____

PACKAGE DIMENSIONS

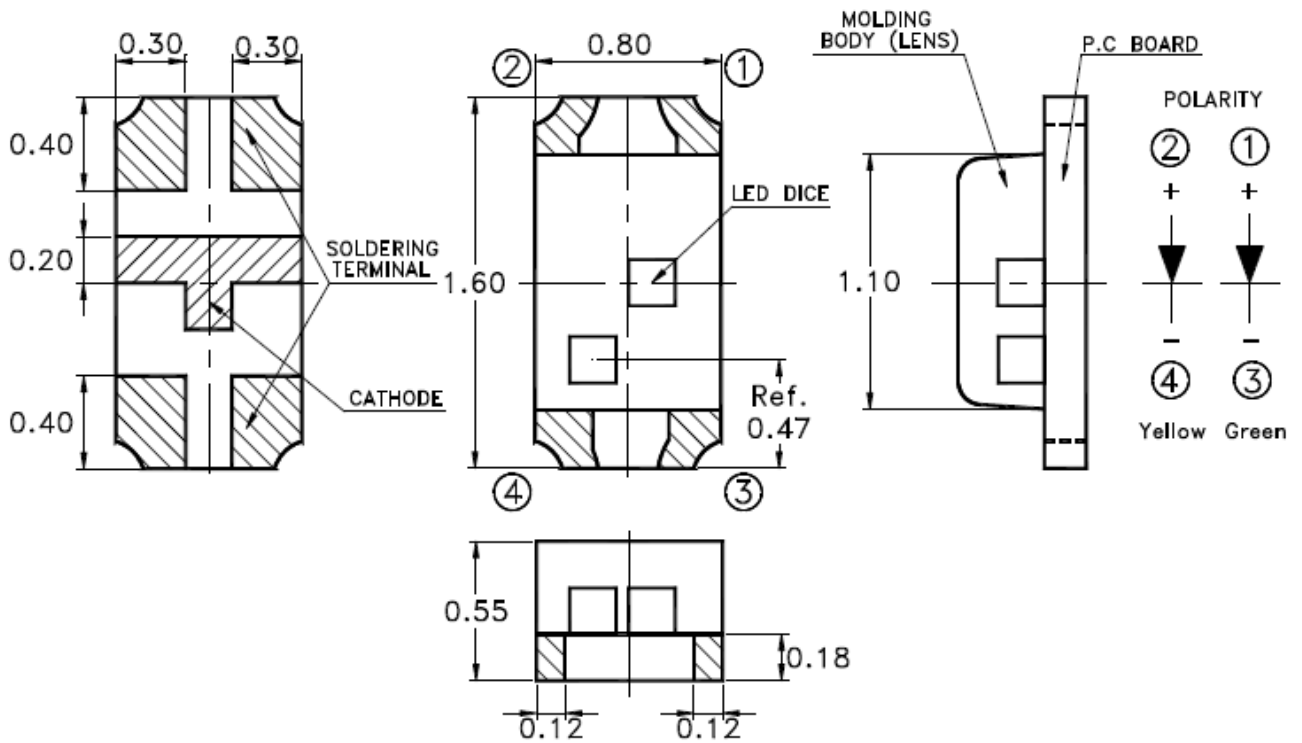

Note:

1. All Dimensions are in millimeters (inches)
2. Tolerance is $\pm 0.10\text{mm}$ (0.004 ") Unless otherwise specified.



1.6*0.8*0.55 mm SMD LED

L-C295KGKYCT

REV: A / 2

FEATURES

- * 1.6*0.8*0.55mm SMD LED
- * LOW CURRENT REQUIREMENT
- * WIDE VIEWING ANGLE
- * SMD LEADS
- * LOW POWER CONSUMPTION

CHIP MATERIALS

- * Dice Material : AlInGaP / AlInGaP
- * Light Color : Green & Yellow
- * Lens Color : Water Clear

ABSOLUTE MAXIMUM RATING : (Ta = 25°C)

SYMBOL	PARAMETER	Green	Yellow	UNIT
PD	Power Dissipation	75	75	mW
If	Forward Current	30	30	mA
Ifp	Peak pulsing current (1/10 duty cycle 0.1ms)	80	80	mA
VR	Reverse Voltage	5		V
Topr	Operating Temperature Range	-40 ~ + 85		°C
Tstg	Storage Temperature Range	-40 ~ + 85		°C

ELECTRO-OPTICAL CHARACTERISTICS : (Ta = 25°C)

SYMBOL	PARAMETER	TEST CONDITION	VALUE			UNIT
			MIN.	TYP.	MAX.	
VF	Forward Voltage	IF = 20mA	Green	2.0	2.4	V
			Yellow	2.0	2.4	
λD	Dominant Wavelength	IF = 20mA	Green	571		nm
			Yellow	589		
λp	Peak Emission Wavelength	IF = 20mA	Green	574		nm
			Yellow	591		
Δλ	Spectral Line Half-Width	IF = 20mA	Green	15		nm
			Yellow	15		
IR	Reverse Current	VR = 5V			10	μA
2θ1/2	Half Intensity Angle	IF = 20mA		130		deg
IV	Luminous Intensity	IF = 20mA	Green	18	112	mcd
			Yellow	45	180	

Typical Electro-Optical Characteristics Curves
(25°C Ambient Temperature Unless Otherwise Noted)

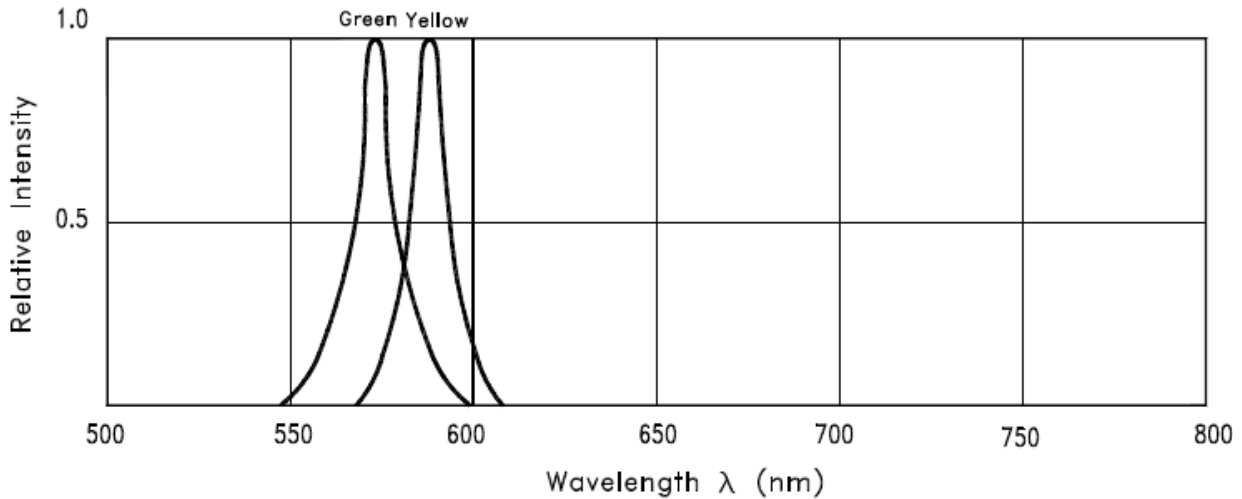

Fig.1 RELATIVE INTENSITY VS. WAVELENGTH

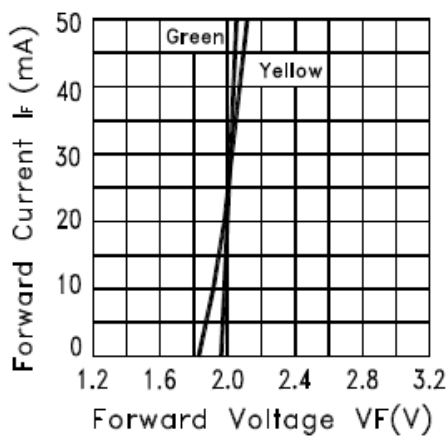

Fig.2 FORWARD CURRENT VS. FORWARD VOLTAGE

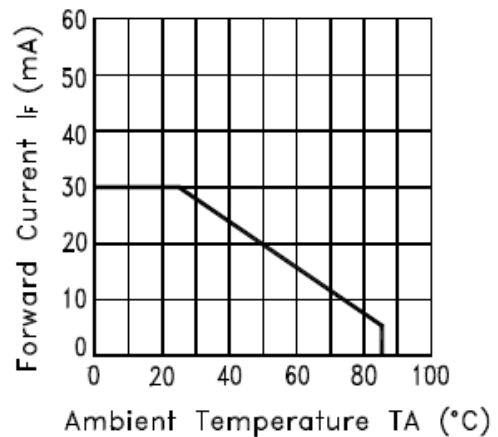

Fig.3 FORWARD CURRENT DERATING CURVE

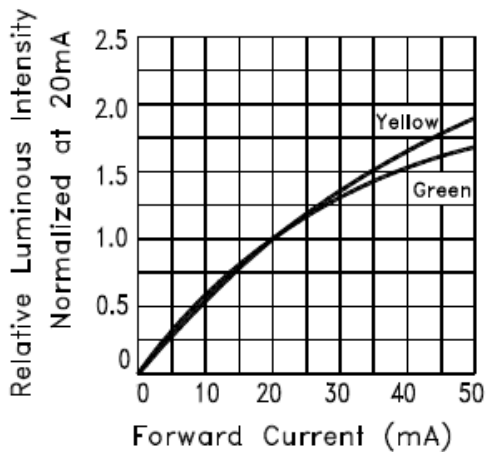

Fig.4 RELATIVE LUMINOUS INTENSITY VS. FORWARD CURRENT

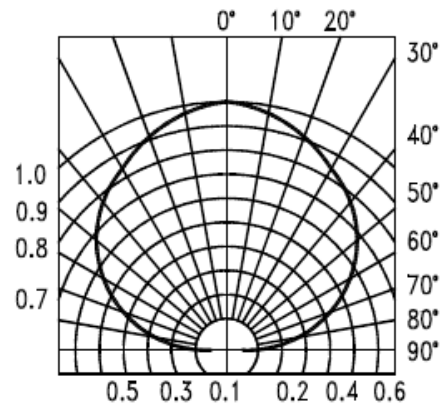

Fig.6 SPATIAL DISTRIBUTION

Cleaning

Do not use unspecified chemical liquid to clean LED they could harm the package.

If clean is necessary, immerse the LED in ethyl alcohol or in isopropyl alcohol at normal temperature for less one minute.

Suggest Soldering Pad Dimensions

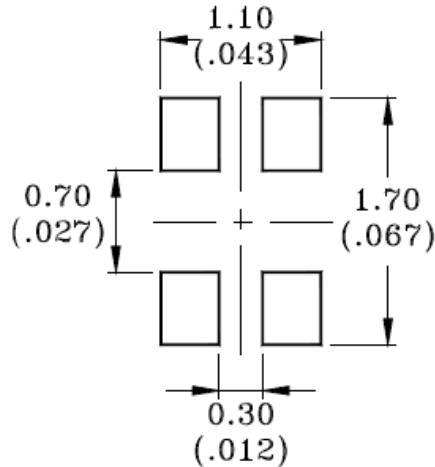

Package Dimensions Of Tape And Reel

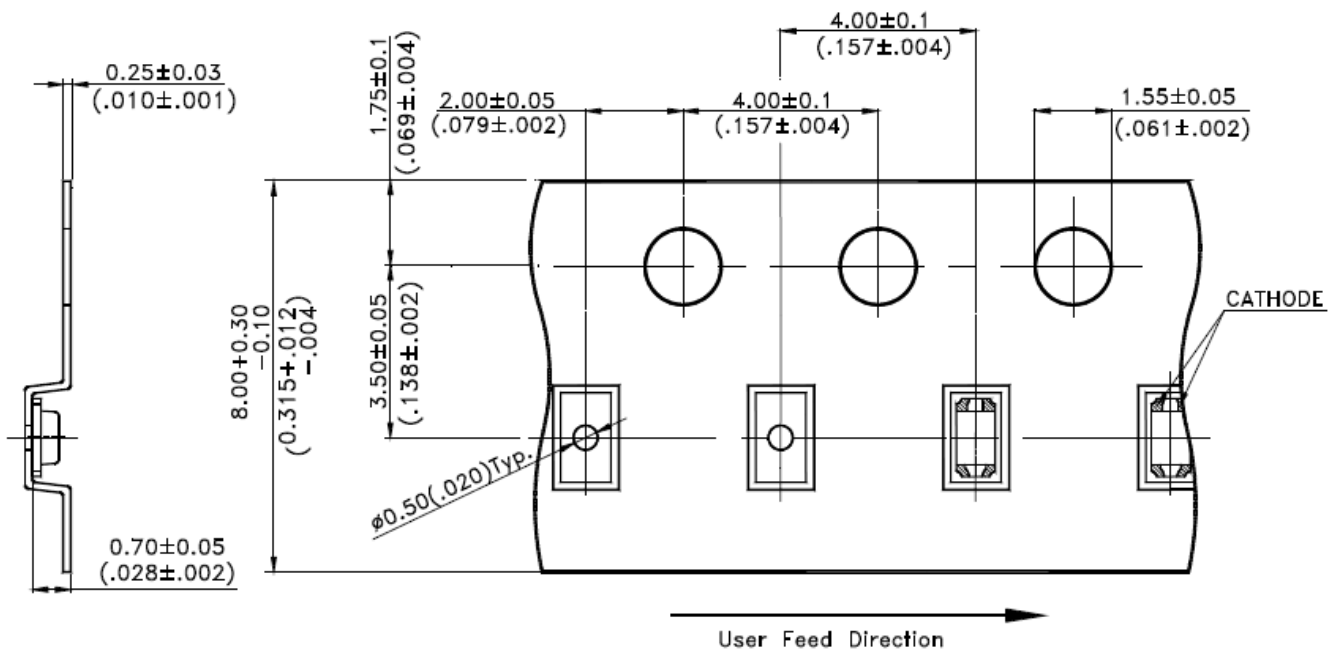

Notes:

1. All dimensions are in millimeters (inches).

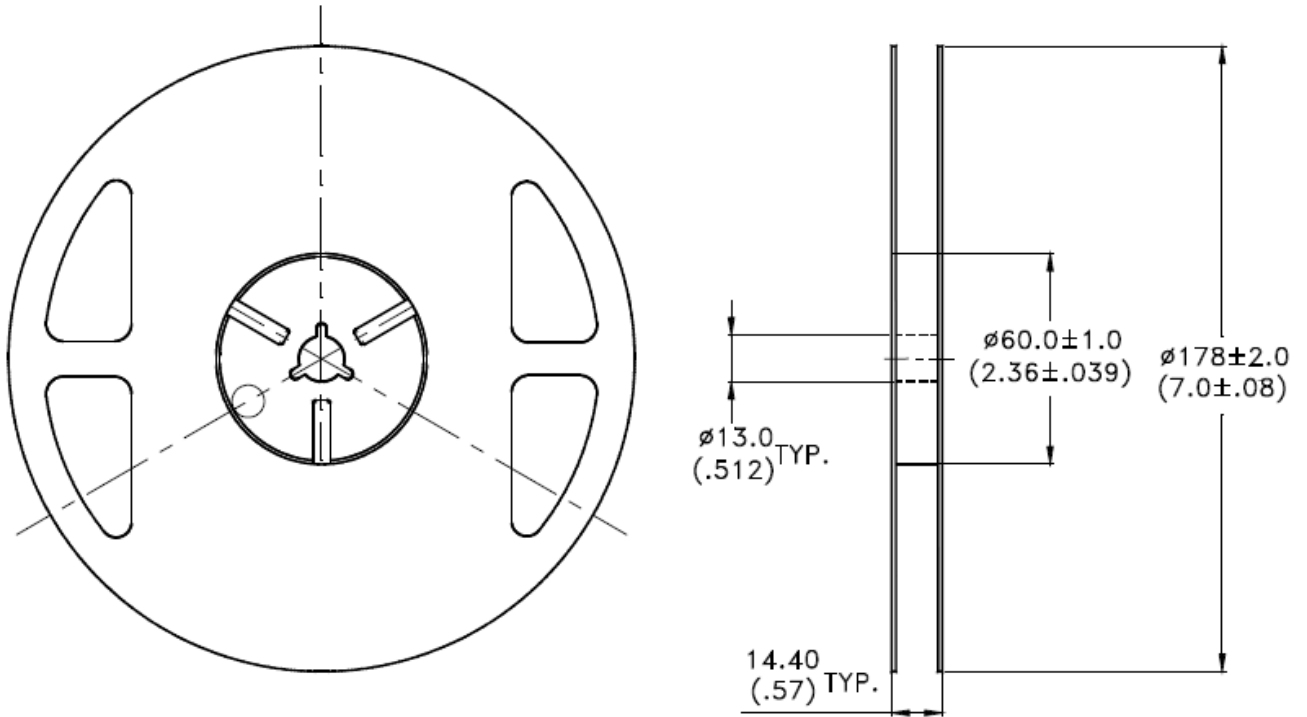

Notes:

1. Empty component pockets sealed with top cover tape.
2. 7 inch reel-3000 pieces per reel.
3. Minimum packing quantity is 500 pcs for remainders.
4. The maximum number of consecutive missing lamps is two.
5. In accordance with ANSI/EIA 481-1-A-1994 specifications.



1.6*0.8*0.55 mm SMD LED

L-C295KGKYCT

REV: A / 2

● Bin Code List

Luminous Intensity (IV), Unit: mcd@20mA					
Green			Yellow		
Bin Code	Bin Code	Bin Code	Bin Code	Min	Max
N	28	45	P	45	71
P	45	71	Q	71	112
Q	71	112	R	112	180

Tolerance of each bin are $\pm 15\%$

Dominant Wavelength (Hue), Unit: nm@20mA					
Yellow			Green		
Bin Code	Min	Max	Bin Code	Min	Max
YA	587	590	GA	567	570
YB	590	593	GB	570	573
YC	593	596	GC	573	576

Tolerance of each bin are $\pm 1\text{nm}$

Suggestion Profile:

(1) Suggestion IR Reflow Profile For Normal Process

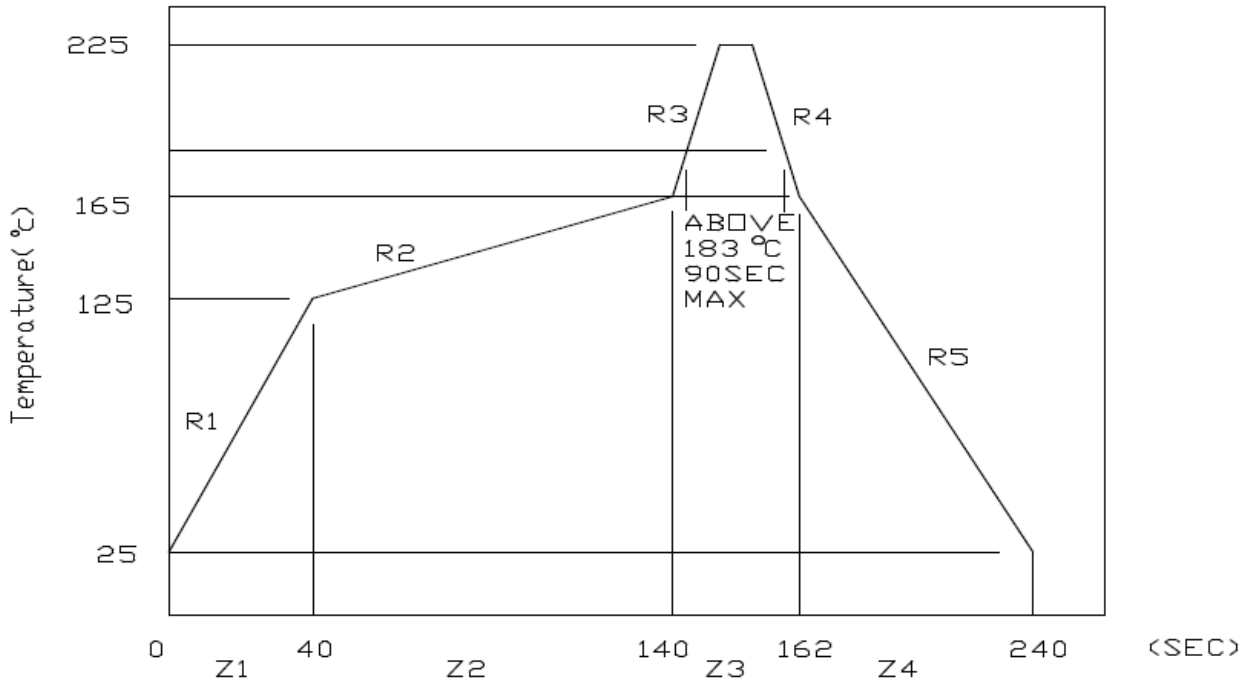

(2) Suggestion IR Reflow Profile For Pb Free Process

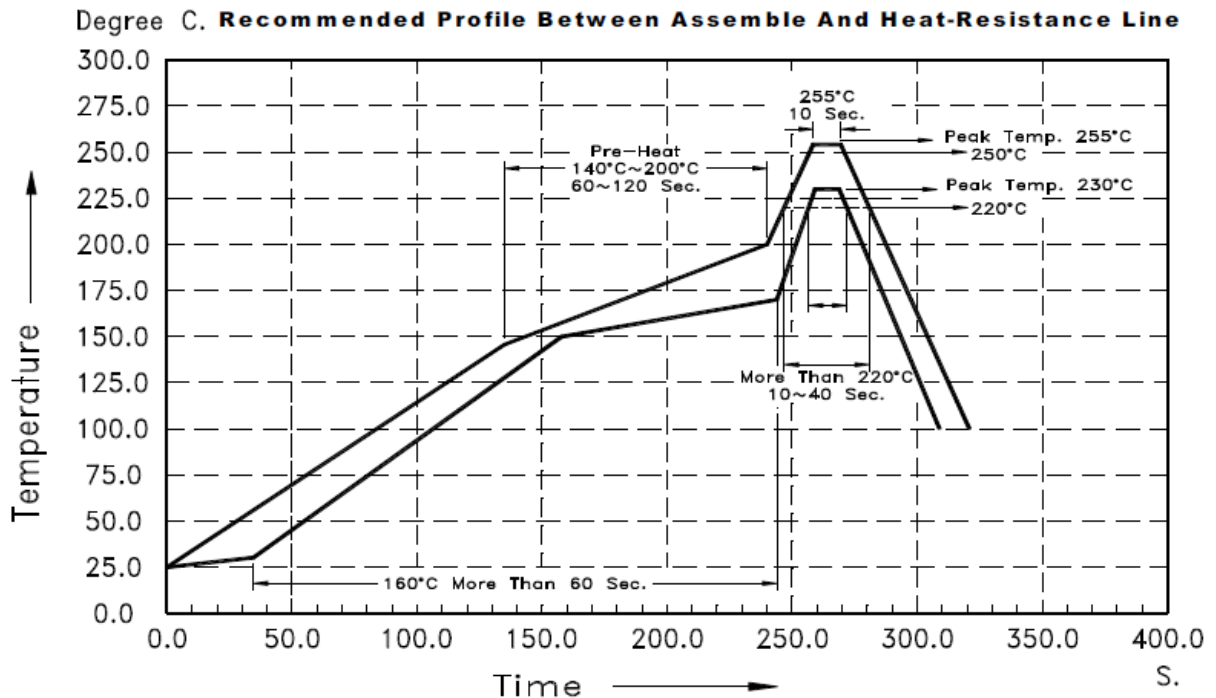

The Profile is available that must to use SnAg_(x=3.3~3.8) Cu_(y=0.2~0.7) solder paste

X-ON Electronics

Largest Supplier of Electrical and Electronic Components

Click to view similar products for [para light manufacturer](#):

Other Similar products are found below :

[UBL-3024-YW](#) [L-SC1R9PD1D1](#) [L3535UVC-K1PC](#) [LS115KRLGCT-20A](#) [L-C153PTDT-Lens-HD](#) [LT5050UVC-XPC](#) [B-1000G-GW](#) [L-C150WDT](#) [LT2835KYCT-BE1](#) [LS115JRJGCT-5A-UEI](#) [LT670KYCT](#) [L329EIR1C-UEI](#) [LT2835WDT-CW0-CM](#) [LC191IR1CT-HF](#) [L524EIR1C](#) [LC295JRLBCT](#) [LC195JRLBCT](#) [L-C170TBCT](#) [A-1001SRBW](#) [L-C175JRJGCT-AM](#) [L314EIR1C](#) [L-C150JRCT](#) [521110R1H-364-G](#) [LC191JGCT-5A](#) [L0001-4589](#) [L-C153CIR1CT-Lens-HD](#) [LT670LGCT](#) [LT670LBCT](#) [LC170WZDT](#) [LS110LGCT](#) [L-C292WDT-5A-YY](#) [L-513ED](#) [LS115JYLGCT](#) [L-C192CWDT-HM](#) [LS110LBCT](#) [LC195JYLGCT](#) [LC150JFCT](#) [LC195JGJYCT-GJ](#) [LC191JFCT-UEI](#) [LT2835IR1CT-150mA-HX](#) [LC295JYJGCT](#) [LC295KGGYCT](#) [L-C170JYCT](#) [L-5T47VB5C-D2-TR](#) [L-5T47LPG41C-D1](#) [L-513HURC](#)