



**PARA LIGHT ELECTRONICS CO., LTD.**

11F., No. 8, Jiankang Rd., Zhonghe Dist., New Taipei City 235, Taiwan

Tel: 886-2-2225-3733

Fax: 886-2-2225-4800

E-mail: [para@para.com.tw](mailto:para@para.com.tw)

[www.paralighttaiwan.com](http://www.paralighttaiwan.com)

**DATA SHEET**

**PART NO.: SZT3014WDT**

**REV: A / 0**

CUSTOMER'S APPROVAL: \_\_\_\_\_

DCC: \_\_\_\_\_

DRAWING NO.: DS-31P-19-0033

DATE: 2019-03-22

PAGE

1

## ■ Package Dimensions

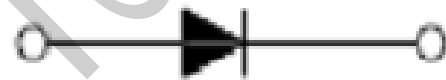
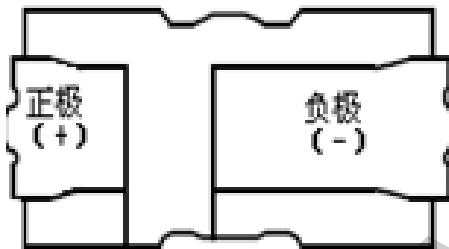
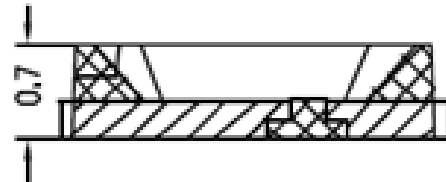
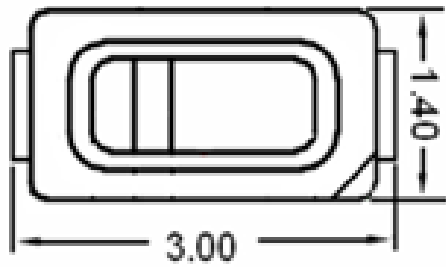
**Notes:**

1. All dimensions are in millimeters.
2. Tolerance is  $\pm 0.1$  mm unless otherwise noted.
3. Specifications are subject to change without notice.

■ Maximum Ratings(Ta=25°C)

Parameter	Symbol	Rating	Unit
Power Dissipation	PD	90	mW
Forward Current *1	IF	30	mA
Operating Temperature Range	Topr	-30~+80	°C
Storage Temperature Range	Tstg	-40~+100	°C
Reverse Voltage	VR	5	V
Soldering Temperature (T=5 sec)	Tsol	260 ± 5	°C

■ Electrical - Optical Characteristics (Ta =25°C)

Parameter	Symbol	Condition	Min.	Typ.	Max.	Unit
Forward Voltage	VF	IF =30mA	2.8	---	3.0	V
Total Flux for white	IV	IF =30mA	6	---	7	lm
CIE-X/Y CIE-X/Y white Bin Information	CIE x	IF = 30mA	0.63	---	0.64	
	CIE y		0.36	---	0.37	
Reverse Current	IR	VR=5V	0	---	10	μA
View Angle	2θ <sub>1/2</sub>	IF =30mA	---	120	---	degree

■ Typical Electro-Optical Characteristics Curves

Forward Voltage VS. Forward Current

正向电压与正向电流特性曲线

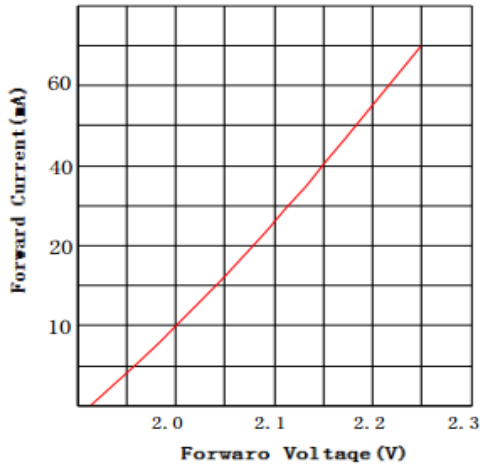

Forward Current VS. Relative Intensity

正向电流与相对光强特性曲线

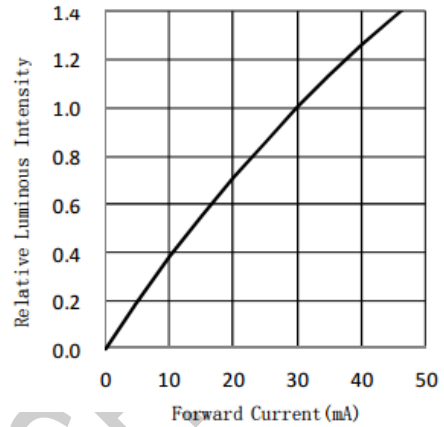

Ambient Temperature vs. Forward Current

环境温度与正向电流特性曲线

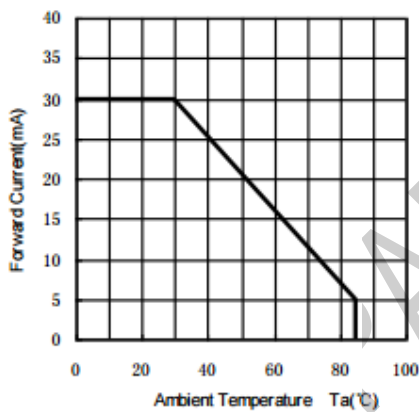

Ambient Temperature VS. Relative Intensity

环境温度与相对光强特性曲线

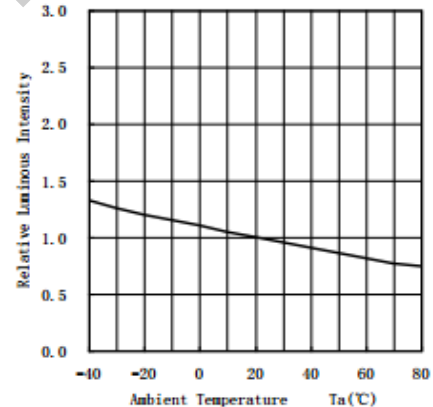

Relative spectral emission 相对光谱分布特性曲线

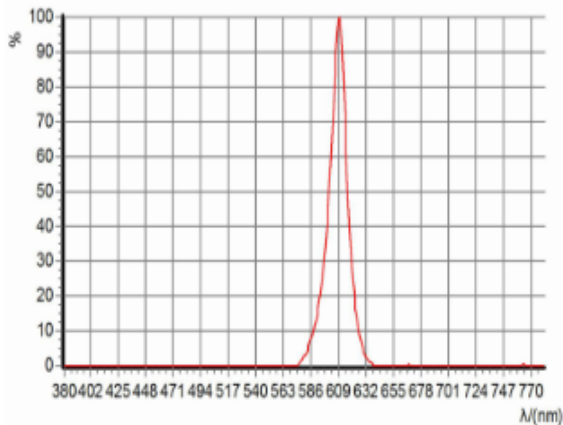

Radiation diagram 辐射图特性曲线

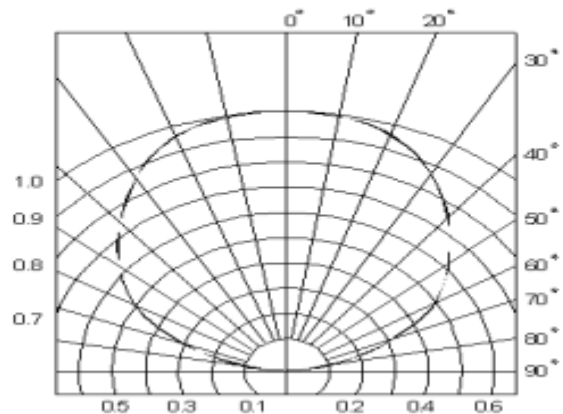

◆Bin Intensity Bin Limits (At 30mA)

BIN CODE	Min(lm)	Max(lm)
C	6.0	7.0

◆Bin VF Bin Limits (At 30mA)

BIN CODE	Min(v)	Max(v)
G1	2.8	2.9
G2	2.9	3.0

◆ Bin Color Bin Limits (At 30mA)

CIE-X/Y色区值 CIE-X/Y white Binning Information

BIN	Chromaticity Coordinates				
OA1	x	0.6275	0.6375	0.641	0.631
	y	0.3645	0.3575	0.364	0.371



BIN : C OA1 G1

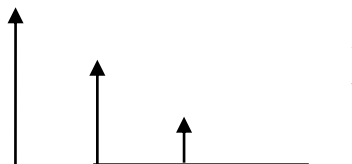

VF BIN CODE  
Wave Length BIN CODE  
Intensity BIN CODE

Notes:

1. Iv: Tolerance for each Bin limit is  $\pm 5\%$
2. Tolerance for each Bin limit is  $\pm 1$
3. VF : Tolerance for each Bin limit is  $\pm 0.05V$

◆ Tapping and packaging specifications(Units: mm)

Label:

Reel Dimensions :

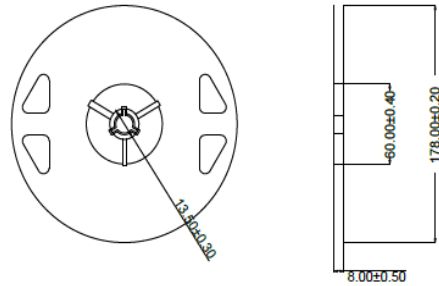

Tape Specifications (Units : mm )

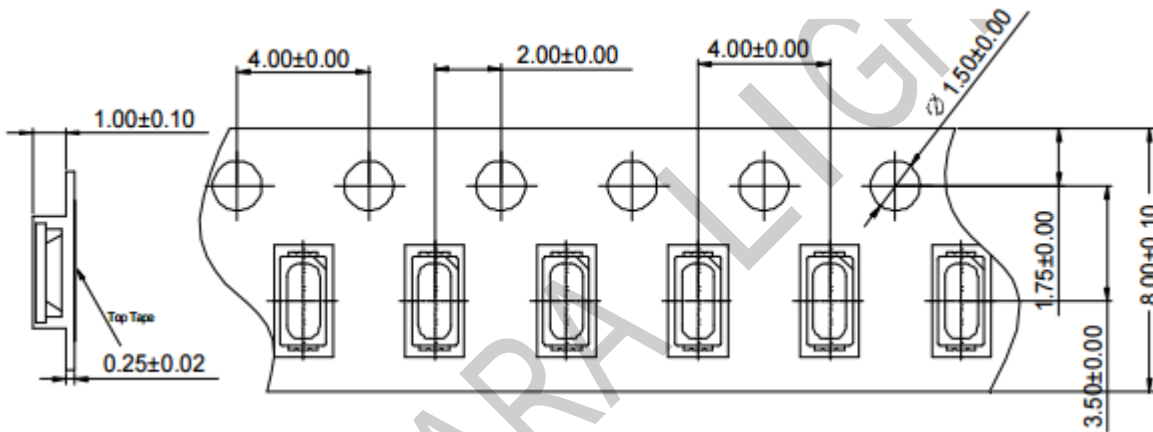

◆ Package Method : (unit:mm)

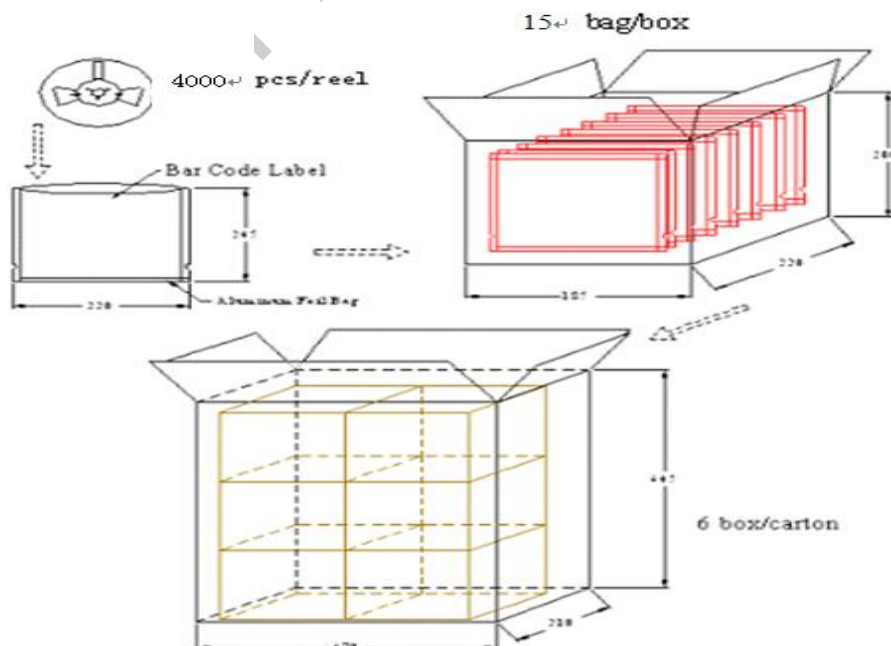

◆ Reliability Test

Classification	Test Item	Reference Standard	Test Conditions	Result
Endurance Test	Operation Life	MIL-STD-750:1026 MIL-STD-883:1005 JIS-C-7021 :B-1	$I_f=10mA$ $T_a=$ Under room temperature Test time=1,000hrs	0/20
	High Temperature High Humidity Storage	MIL-STD-202:103B JIS-C-7021 :B-11	$T_a=+65^{\circ}C\pm 5^{\circ}C$ RH=90%-95% Test time=168hrs	0/20
	High Temperature Storage	MIL-STD-883:1008 JIS-C-7021 :B-10	High $T_a=+85^{\circ}C\pm 5^{\circ}C$ Test time=1,000hrs	0/20
	Low Temperature Storage	JIS-C-7021 :B-12	Low $T_a=-35^{\circ}C\pm 5^{\circ}C$ Test time=1,000hrs	0/20
Environmental Test	Temperature Cycling	MIL-STD-202:107D MIL-STD-750:1051 MIL-STD-883:1010 JIS-C-7021 :A-4	$-35^{\circ}C \sim +25^{\circ}C \sim +85^{\circ}C \sim +25^{\circ}C$ 60min 20min 60min 20min Test Time=5cycle	0/20
	Thermal Shock	MIL-STD-202:107D MIL-STD-750:1051 MIL-STD-883:1011	$-35^{\circ}C\pm 5^{\circ}C \sim +85^{\circ}C\pm 5^{\circ}C$ 20min 20min Test Time=10cycle	0/20
	Solder Resistance	MIL-STD-202:201A MIL-STD-750:2031 JIS-C-7021 :A-1	Preheating: $140^{\circ}C-160^{\circ}C$ , within 2 minutes. Operation heating : $260^{\circ}C$ (Max.), within 10seconds. (Max.)	0/20

◆Recommended Soldering Pattern(unit:mm)

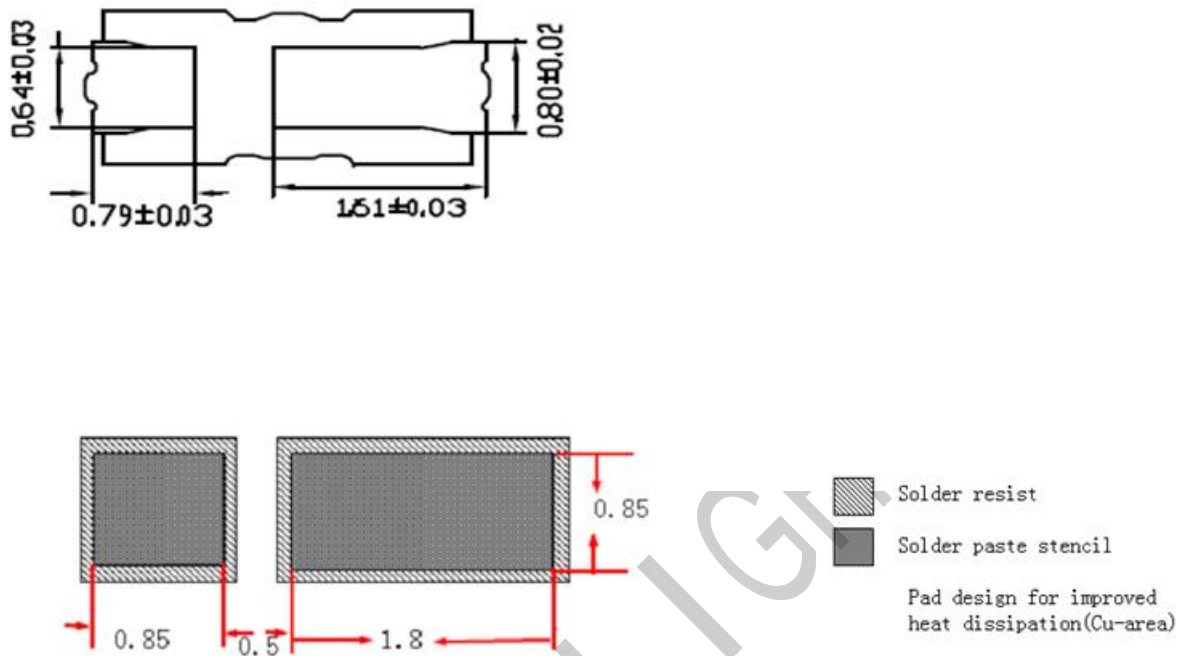

◆Soldering :

1. Manual Soldering

The temperature of the iron tip should not be higher than 350°C and Soldering time to be within 3 seconds per solder-pad.

2. Reflow Soldering Temp/Time

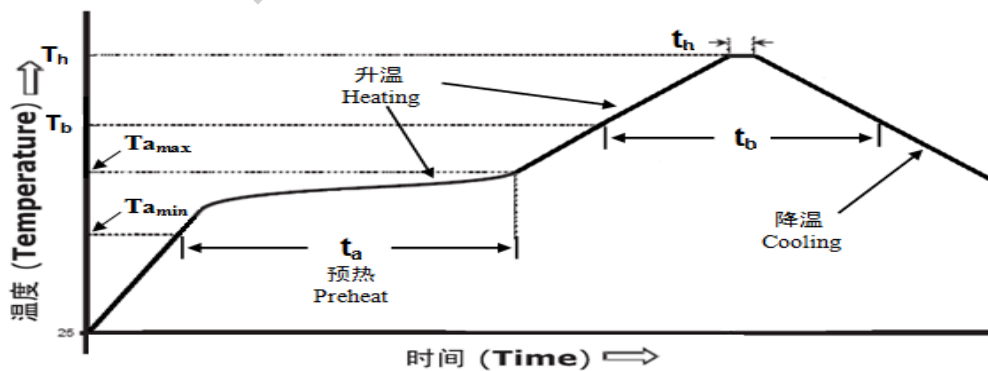



温度曲线参数 Temperature curve Parameters	铅锡膏 Lead solder paste	无铅锡膏 Lead -free solder paste
温变速度 The rate of temperature	4°C/SEC.MAX	4°C/SEC.MAX
预热最低温度 Preheat: Min temperature (Tamin)	100°C	120°C
预热: 最大温度 Preheat: Max temperature (Tamax)	150°C	180°C
预热时间 Preheat time (tamin to tamax )	60~100 SEC	60~120 SEC
焊接温度 Soldering temperature (T <sub>b</sub> )	180°C	217°C
焊接时间 Soldering time (tb)	60~120 SEC	60~120 SEC
峰值温度 Peak temperature	215°C	260°C
峰值温度时间 Peak temperature time	10 ~15 SEC	5~10 SEC
冷却速度 Cooling speed	6°C/SEC.MAX	6°C/SEC.MAX

**Judgment criteria of failure for the reliability**

Measuring items	Symbol	Measuring conditions	Judgement criteria for failure
Forward voltage	V <sub>F</sub> (V)	I <sub>F</sub> =30mA	Over U <sup>1</sup> x1.2
Reverse current	I <sub>R</sub> (uA)	V <sub>R</sub> =5V	Over U <sup>1</sup> x2
Luminous intensity	I <sub>v</sub> ( lm )	I <sub>F</sub> =30mA	Below S <sup>1</sup> X0.5

**Note:**

1. U means the upper limit of specified characteristics. S means initial value.
2. After each test, remove test pieces, wait for 2 hours and test pieces have returned to ambient temperature, then take next measurement.



## SURFACE MOUNT DEVICE LED

Part No.: SZT3014WDT

EV: A / 0

### ◆ Storage:

1. recommended storage condition: At 5°C-30°C and relative humidity 50% RH Max.
2. After this bag is opened, devices that will be applied to infrared reflow, vapor-phase reflow, or equivalent soldering process must be:
  - a. completed within 24 hours
  - b. Stored at less than 30% RH.
3. Devices require baking before mounting, if:
  - 2a or 2b is not met.
4. If baking is required, devices must be baked under below conditions:
  - 12 hours at 60°C±3°C

### ◆ Note:

- (1) Care must be taken not to damage LED's silicone resin while exposing to high temperature or contact LED's silicone resin with hard or sharp objects, such as metal hook, tweezers or sand blasting..
- (2) Current limiting resistor must be used in the circuit to drive Grand LEDs within the rated figures and not to overload Grand LEDs with instantaneous voltage at the turning ON and OFF cycles. When using pulse driving, the average current must be within the rated figures. And the circuit should be designed to avoid reverse voltage when turning off the Grand LEDs.

### ◆ Package and Label of Products:

Package: Products are packed in one bag of 4000 pcs (one taping reel) and a label is attached to each bag.

## X-ON Electronics

Largest Supplier of Electrical and Electronic Components

*Click to view similar products for [Standard LEDs - SMD category](#):*

*Click to view products by [Para Light manufacturer](#):*

Other Similar products are found below :

[LTST-C190KYKT](#) [LTST-C19GD2WT](#) [LTST-N683GBEW](#) [LTW-170ZDC](#) [LTW-M140SZS40](#) [LTW-M140ZVS](#) [598-8110-100F](#) [91-21SUBCS400-A6TR7](#) [AAAF5060QBFSEEZGS](#) [APT1608QGW](#) [EAST2012YA0](#) [99-213/R6C-AR2T1B/2C](#) [SML-LX0606SISUGC/A](#) [SML-LXR851SIUPGUBC](#) [LT1ED53A](#) [AM27ZGC03](#) [APFA3010SURKCGKQBDC](#) [APHK1608VGCA](#) [APT2012QGW](#) [LTST-008BGEW](#) [LTW-010DCG](#) [LTW-020ZDCG](#) [LTW-21TS5](#) [LTW-220DS5](#) [LO T67F-V1AB-24-1](#) [598-8330-117F](#) [CMDA20AYAA7D1S](#) [95-21SURCS530-A3TR10](#) [HSMQ-C177](#) [598-8040-100F](#) [598-8070-100F](#) [598-8140-100F](#) [598-8610-200F](#) [SML-LXL1209SYC/ATR](#) [CMD91-21VRC/TR7](#) [SML-LXR851SGSIC-TR](#) [SML-512PWT86A](#) [SMF-2432GYC-TR](#) [EASV3015RGYA0](#) [LTST-C190KFKT-5A](#) [LTST-C194TBKT-5A](#) [CLX6E-FKC-CH1M1D1BB7C3D3](#) [SML-LXL0805USBC-TR](#) [SML-LX2835SYSUGCTR](#) [LTW-M670ZVS-M5](#) [APA2106ZGC/G](#) [CLMXB-FKA-CbcfghjnpACBB79463](#) [VFA1101W-5AY3B2-TR](#) [LCB P473-P2R2-3J7L-1-Z](#) [HSMR-C197](#)