



Content

- 3 Welcome
- 4 About Partex. Why mark?
- 5 Standards and Certificates
- 6 Methods of marking and type of packaging
- 7 Article number: International colour code
- 8 Product overview / Index
- 14 Products



Welcome,

We are very proud of our company's dynamic development and how we invest in the future, in new technologies and environmentally friendly solutions.

Partex lead the world in industrial marking systems. We manufacture products for the identification of wires, cables, pipes and components. From the individual electrician to the world's largest companies, our unique marking systems contribute towards increased efficiency and higher safety levels.

Partex consists of a parent company and several subsidiaries. However, we want to be known as one organization, rather than as several separate companies. We want the family culture and atmosphere of the parent company Partex Gullspång in Sweden, to permeate the entire group, creating one big family.

On the following pages we invite you to familiarize yourself with our company and our products.





Partex UK headquarters

PARTEX MARKING SYSTEMS was founded in 1948 by Tore Lööf in Gullspång, Sweden. Since the beginning we have engaged in the production of complete marking systems and cable accessories.

Many of our clients know that Partex is a Swedish company and that we introduced the most popular one-character marker, the PA-marker. But you should know that our offer is much wider. This catalogue will be a useful guide to the world of marking systems and cable accessories.

It is worth mentioning that many of our products were established in response to specific requests from customers who had problems with identification. If you have a special requirement, do not hesitate to contact us as soon as possible.

WHY MARK?

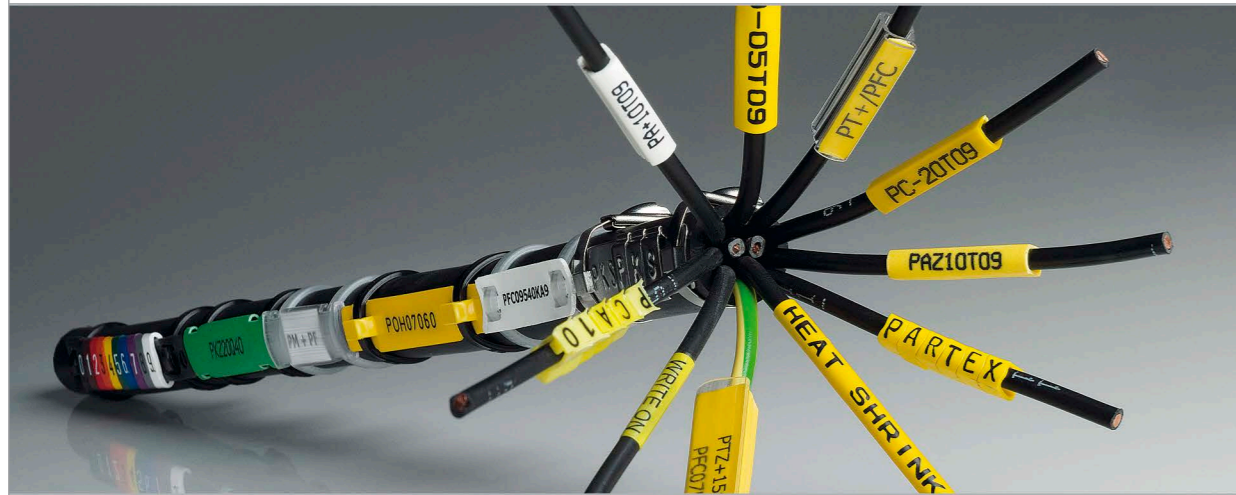

Marking increases safety, reduces wasted time in manufacturing and production stoppages. Furthermore, marking simplifies maintenance and reduces costs for service, production loss, fault identification, repairs and exchange of electrical equipment.

Why Choose Partex? Partex offers a complete range of marking products. We have over 60 years' experience of development and manufacturing that has given us a unique expertise and knowledge in the field.



In order to ensure that our products have a high and consistent quality, they are subjected to numerous tests at the National Institute for Research and Testing in Sweden. Detailed research and stringent tests are carried out, such as the impact of mold, rust, fire, extreme temperatures, UV radiation and various chemicals.

Below is a list of tests.

TEST	METHOD
Flammability	according to UL 94
Low temperature	markers are kept at -30° C for 4 hours. Checking cracks, fractures and similar damage. In addition, the ease of assembly is checked.
High temperature	markers kept at a temperature of 70° C for 1 hour. If the material has passed the test, the test is repeated at a higher temperature.
Aging resistance	accelerated thermal aging, corresponding to the use of material through 30 years at 20° C. Checking cracks, fractures and similar damage. (Up to 50% reduction in elongation before fracture). In addition, the possibility of assembly is checked.
UV resistance	accelerated UV-test, corresponding to ISO 4892-2. Exposing the material to sunlight for a period that equals one year in southern Sweden. Checking for fading, changes in color and readability of the print.
Resistance to abrasion (text)	in accordance with Method 2172 Swedish National Testing and Research Institute (machine abrasive). Using a load of 75 g per millimeter.
Chemical resistance	mounted markers are immersed in the chemical agent at a temperature of 23° C - 2 C, left for 2 hours, and then checked for functionality, durability, color and clarity of printing. Chemicals used: synthetic diesel fuel, sulfuric acid (25%), cleaning agent (Berol 226, 10%), distilled water, sea water (5% NaCl), transformer oil (Nytro 10X) and Ethanol (95%).
Dielectric resistance	in accordance with IEC 93
Ozone resistance	the test samples are extended by 33% and exposed to ozone to 100 ± 5 ppm at 65° C to -2° C for 192 hours.

Certified to:
ISO 9001



+ MARKING METHODS

123
M1 SINGLE CHARACTER MARKERS

Consists of single character markers that can be combined with each other to give total marking flexibility.

123
M2 MULTI CHARACTER MARKERS

Allows you to order markers already printed with the complete information in accordance with your specification.

123
M3 ON-SITE

Allows you to produce your own markers on site with one of Partex marking machines.

+ PACKAGING



reel of 1000 pcs



on a reel / in a bag



on reels



disc of 250/500 pcs



un sorted



in a bag



multi pack



on tape / sheet



boxed reel



handy pack of 250 pcs

PA-10003BV40.1

1 2 3 4 5 6 7 8 9

1. Product series

PA = PA profile
PO = PO profile
PK = PK profile

2. Variations

Z = Zorex / Halogen free
- = Standard version
+ = An improved product

3. Size

4. Length

5. Packaging

A = Cut / loose markers in a bag
B = Semi cut markers on reel
P = Semi cut markers in strips in bags
S = Semi cut markers on compact disc

6. Type of print

B = Black ink jet print
V = Hot stamped print
N = Neutral / Blank markers

7. Colour of profile

Colours according to the international colour code

8. Colour of print

Print colour according to the international colour code.
Some products can only be printed in black or white.

9. Type of characters

A-Z Letters
0-9 Numbers
Special characters such as: + - / earth sign etc.

INTERNATIONAL COLOUR CODE

We offer several types of printing. For example, single-character markers are hot stamped and multi-character markers are printed with ink or thermal transfer.

The colours of our markers are consistent with international colour code shown below.



0 black marker (RAL9011)
white print



7 violet marker (RAL4006)
white print



1 brown marker (RAL8015)
white print



8 grey marker (RAL7005)
black print



2 red marker (RAL3018)
white print

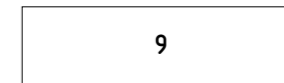

9 white marker (RAL9010)
black print



3 orange marker (RAL2004)
black print



yellow-green marker
black print



4 yellow marker (RAL1021)
black print



red marker,
white print



5 green marker (RAL6001)
white print



blue marker,
white print



6 blue marker (RAL5010)
white print





PY
Single character closed markers for wires with small diameters.

▶ page 14



PA/PAZ
Single character closed markers. Chevron Cut.

▶ page 14



PZ
Single character closed markers. Straight Cut.

▶ page 16



PC
Single character open markers.

▶ page 18



PCA
Single-character open marker.

▶ page 20



PK+
Single-character markers mounted on wires.

▶ page 22



PA+/PC/PK+
Multi-character marking
Markers printed according to customer requirements.

▶ page 26



PO/POZ
Multi-character marking
Oval profile for marking wire and cable (POZ - Halogen-free).

▶ page 28



PHZ
Multi-character marking
Heat-shrink tubing for thermal transfer printers.

▶ page 32



PHZF
Multi-character marking
Flat, halogen free heat shrink for thermal transfer printers.

▶ page 34



SG/MS/HF/NF/EF/ET
ProSleeve ladder format printable heat-shrink tubing.

▶ page 36-46



PT+
PA type sleeve with oval, transparent pocket for marker tags.

▶ page 48



PTZ+
Multi-character marking
Halogen free, PA type sleeve with oval, transparent pocket for marker tags.

▶ page 48



PTC
Multi-character marking
PC type sleeve with oval, transparent pocket for marker tags.

▶ page 50



PM
Transparent holder for cable marking. Mounted with cable ties.

▶ page 52



PTM
Transparent holder for cable marking. Mounted with cable ties.

▶ page 54



PK+
Single-character markers mounted on PDH or PKH carriers.

▶ page 22



PPQ
Flat and flexible cable marker.

▶ page 56



TIE/TAG
Write-on identification tags.

▶ page 70



PO/POZ
Multi-character marking
Oval profile for marking wire and cable (POZ - Halogen-free).

▶ page 28



PHZ
Multi-character marking
Heat-shrink tubing for thermal transfer printers.

▶ page 32



PHZF
Multi-character marking
Flat, halogen free heat shrink for thermal transfer printers.

▶ page 34



CMZ/CMM/CMD/CML/CMT
ProSleeve ladder format printable cable markers.

▶ page 58-62



SG/MS/HF/NF/EF/ET
ProSleeve ladder format printable heat-shrink tubing.

▶ page 36-46



PKS - single character
Stainless steel single-character markers mounted on a metal holder.

▶ page 64



PKS - Multi-character
Multi-character markers embossed according to specification, with up to four lines of text.

▶ page 66



PKS
Stainless steel markers laser etched with specified text or symbols.

▶ page 68



PFC
Printable marker cards, made from halogen free material.

▶ page 85

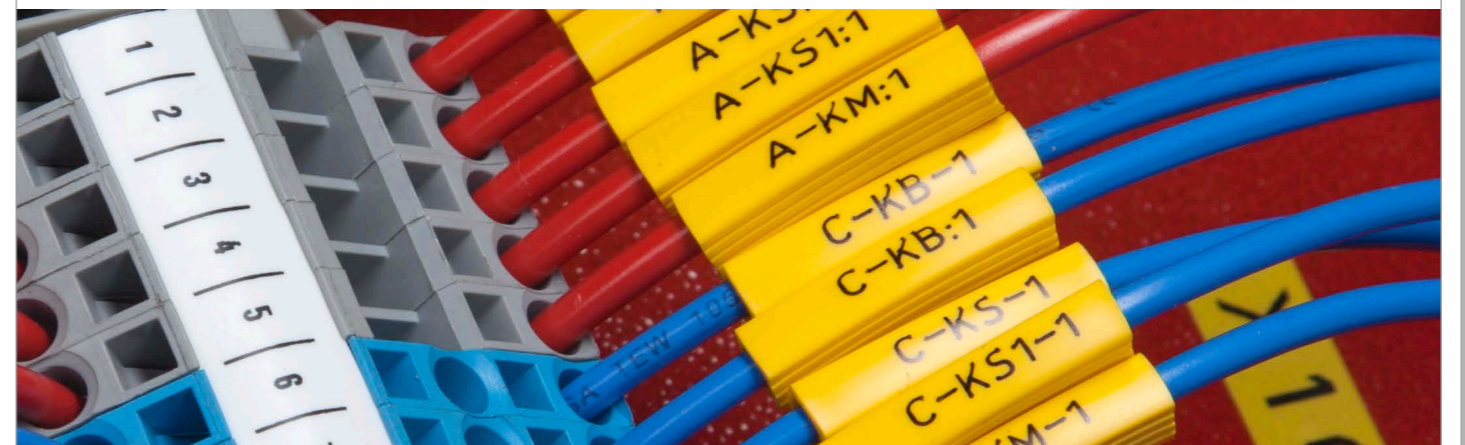
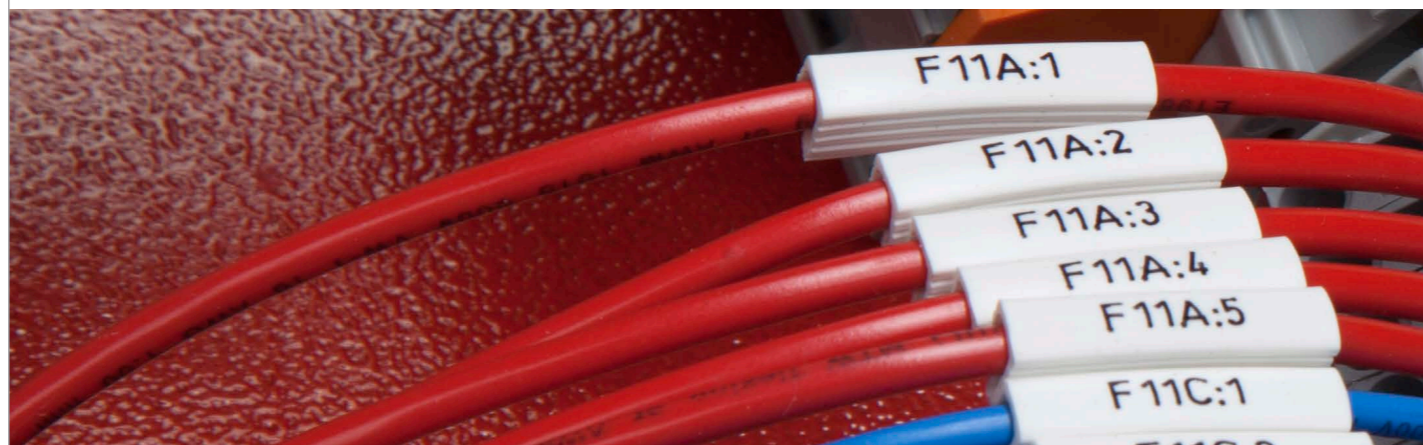



PROMARK-T1000
Professional and portable thermal transfer printer for the production of markers.

▶ page 100



EOS1
A compact thermal transfer printer suitable for printing onto PPG cable markers.

▶ page 104



MK10
Thermal transfer industrial printer to print markers

▶ page 106



MK10-DH
Thermal transfer industrial printer to print double-sided markers

▶ page 108



PRIMACY
Thermal transfer printer specifically designed for PFC cards.

▶ page 112

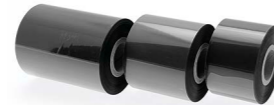

RIBBONS
Thermal transfer ribbons for use in the EOS1, MK10 and MK10-DH printers

▶ page 81



WinSign
Software for controlling Partex marking machines

▶ page 114



HFC
Halogen-free cable ties made from Nylon 6.6.

▶ page 95



HFC-UV
Cable Ties for outdoor use

▶ page 96



MAR
Cable ties for marking

▶ page 97



TT1
Automatic tool for nylon cable ties

▶ page 97



SST
Stainless steel cable ties

▶ page 98



SSTC
Coated cable ties Cable ties in stainless steel, coated with a layer of polyester

▶ page 99



SSTM
Mounts for Stainless steel cable ties

▶ page 97



SSTG/SSAT
Tensioning tools for stainless steel cable ties

▶ page 97



TIE PEN
Pen for manual marking of markers

▶ page 71



SP
Spiral tube

▶ page 94



PE-P
Plates engraved with a two-layer plastic laminate

▶ page 72



SSDT
Stainless steel dog tags laser engraved

▶ page 73



SL/CL
Warning, Danger and PAT test labels

▶ page 74



EPL/EPF
Pro Sleeve ladder format printable panel labels

▶ page 80



PS - Component markers
Universal markers for marking modular and electrical components

▶ page 82



PP+
Flat profile for insertion into marker carriers or mounted terminal blocks

▶ page 84



PPA+
Self-adhesive flat profile for component marking

▶ page 84



PROMARK-PL
Self-adhesive labelling tape

▶ page 103



CAS
Cassettes to store single-character markers PA.

▶ page 86



MD/MDH
Holder and applicators for single marker PA.

▶ page 87



PLD
Self-adhesive wrap around markers

▶ page 88



PUJ/MD10
Applicators for easy assembly of single character markers

▶ page 89



PAL/B
Box for storage of single-character markers

▶ page 90



PAL/50
Box for storage of single-character markers

▶ page 91



SRC-T
Cardboard marker dispenser

▶ page 92



SRP
Heavy duty, steel marker dispenser

▶ page 93

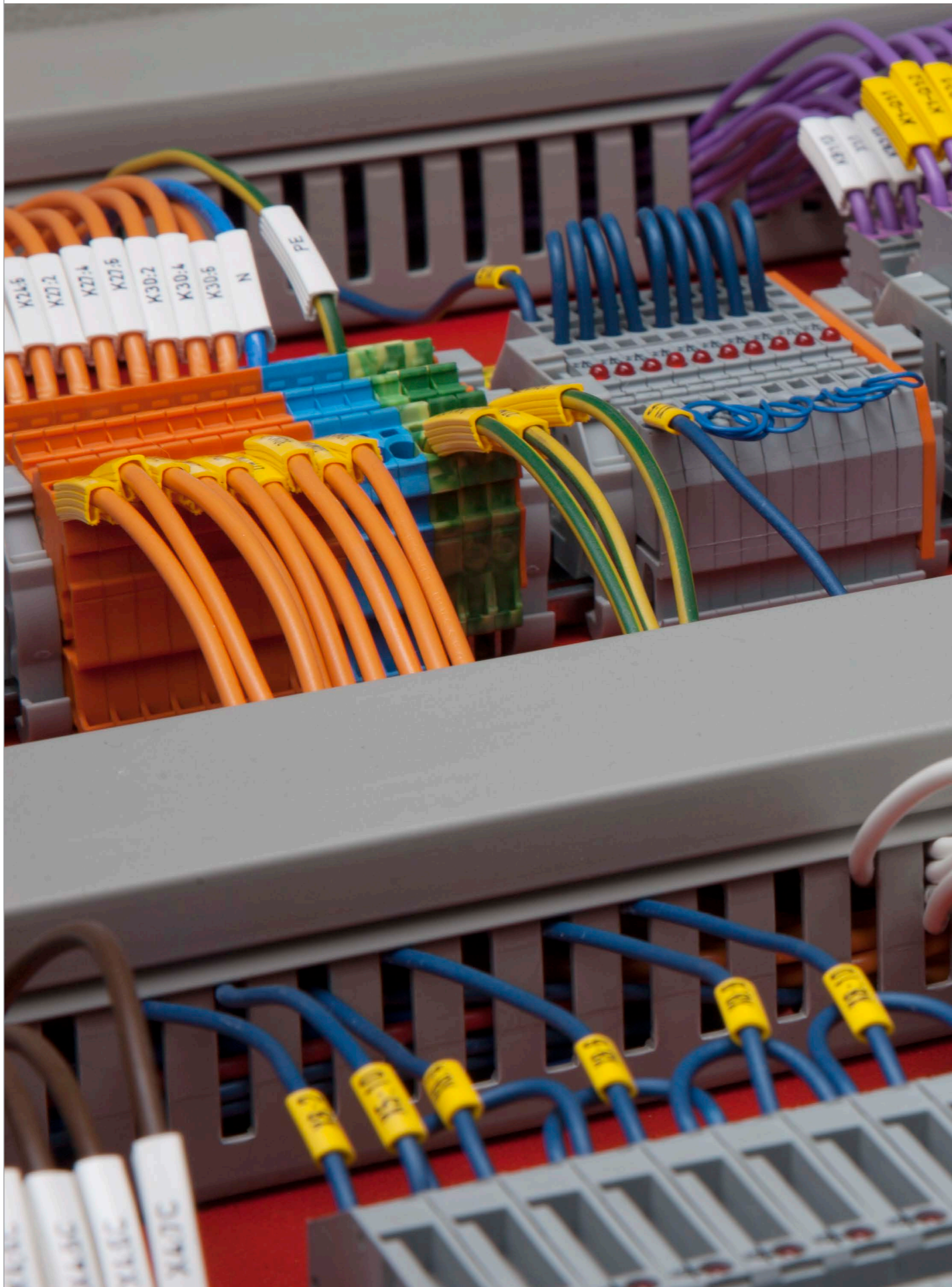



+ INFORMATION

- + Closed, permanent grip and adjustable marker sleeves
- + For applications including electrical engineering, pneumatics and hydraulics
- + Twist-protection for secure combination marking
- + Excellent legibility

+ PROPERTIES

Temperature range

PA: -30°C to +60°C

PAZ: -30°C to +90°C

Material

PA: PVC

PAZ: ZEREX (Halogen free)

Print

hot stamped

Standard colours

PA: yellow and white

international colour code for 0-9

PAZ: yellow and white

Text

0-9, A-Z, +, -, /, ~, ↓

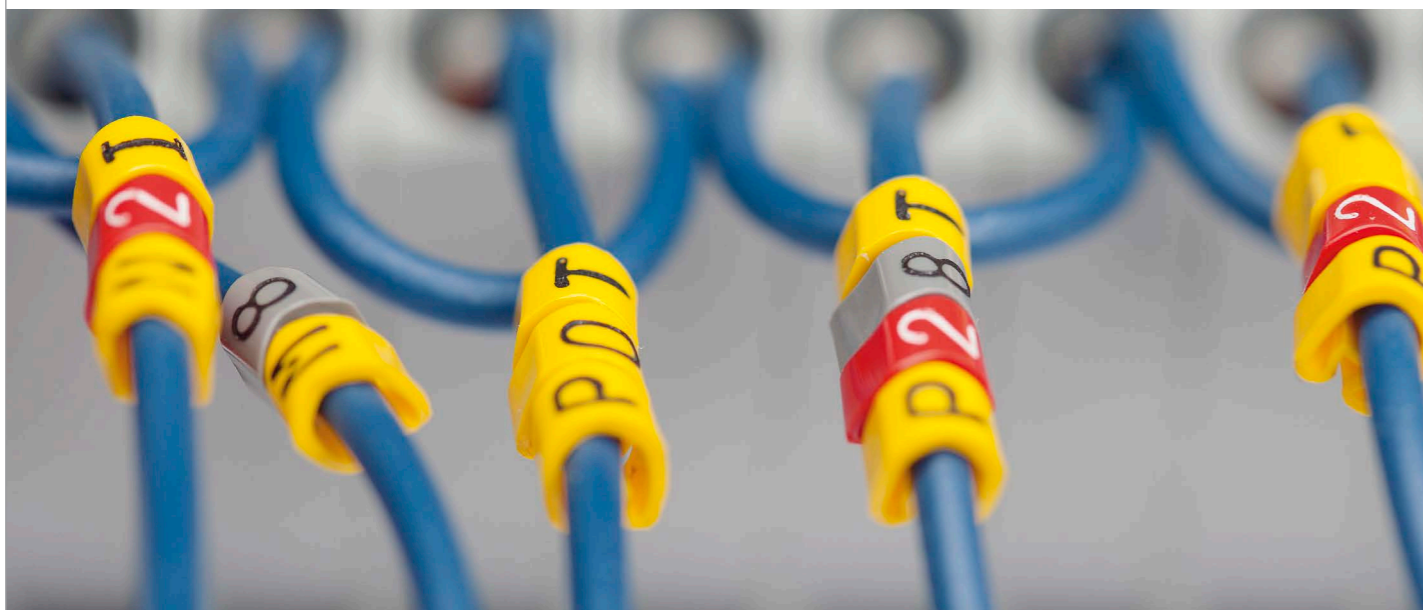

+ DIMENSIONS

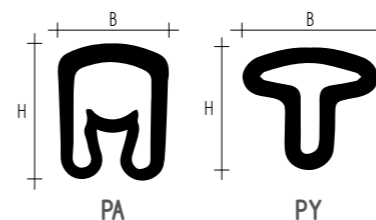

TYPE	HEIGHT (H mm)	WIDTH (B mm)	TEXT HEIGHT (mm)
PY-01	33	35	26
PA-02	36	35	26
PA-1	55	4.2	26
PA-2	9.5	6.6	4.0
PA-3	16.5	11.0	4.0

+ SIZES AND PACKAGING

TYPE	DIAMETER / AREA*	LENGTH	NUMBER OF CHARACTERS	PACKAGING
PY-01	~10 - 2.0 mm ~0.2 - 0.7 mm ²	3 mm	1	bag of 5x200 pcs - cut roll of 1000 pcs
PA-02/PAZ02	~13 - 3.0 mm 0.5 to 0.75 mm ²	3 mm	1	bag of 5x200 pcs - cut disc of 500 pcs
PA-1/PAZ1	~25 - 5.0 mm 0.75 to 4.0 mm ²	3 mm	1	bag of 5x200 pcs - cut disc of 500 pcs
PA-2/PAZ2	~4.0 - 10.0 mm 2.5 to 10.0 mm ²	4 mm	1	bag of 5x100 pcs - cut disc of 250 pcs
PA-3/PAZ3	~8.0 - 16.0 mm 16.0 to 50.0 mm ²	6 mm	1	bag of 5x20 pcs - cut

* Size shown refers to BS6231 tri-rated cable.

+ RELATED PRODUCTS



MD/MDH
PAGE 87



CAS
PAGE 86



PUJ/MD10
PAGE 89

+ APPLICATION

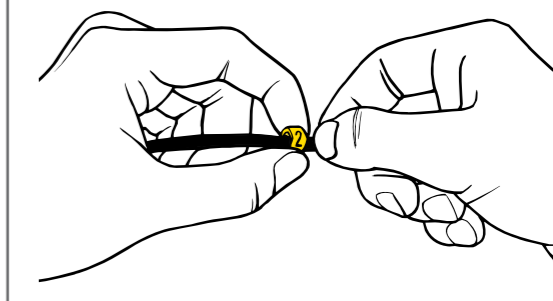



+ INFORMATION

- + Closed, permanent grip and adjustable marking sleeves
- + For applications including electrical engineering, pneumatics and hydraulics
- + Twist-protection for secure combination marking
- + Excellent legibility

+ PROPERTIES

Temperature range
-30°C to +60°C

Material
PVC

Print
hot stamped

Standard colours
yellow and white
international colour code for 0-9

Text
0-9, A-Z, + - / : ~ ⊥



+ DIMENSIONS

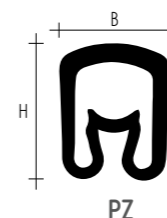

TYPE	HEIGHT (H mm)	WIDTH (B mm)	TEXT HEIGHT (mm)
PZ-02	36	35	26
PZ-1	55	42	26
PZ-2	95	66	40

+ SIZES AND PACKAGING

TYPE	DIAMETER / AREA*	LENGTH	NUMBER OF CHARACTERS	PACKAGING
PZ-02	~13 - 3.0 mm 0.5 to 0.75 mm ²	3 mm	1	bag of 5x200 pcs - cut bag of 250 pcs - strips
PZ-1	~25 - 5.0 mm 0.75 to 4.0 mm ²	3 mm	1	bag of 5x200 pcs - cut bag of 250 pcs - strips
PZ-2	~40 - 10.0 mm 2.5 to 10.0 mm ²	4 mm	1	bag of 5x100 pcs - cut bag of 250 pcs - strips

* Size shown refers to BS6231 tri-rated cable

+ RELATED PRODUCTS



MD/MDH
PAGE 87



CAS
PAGE 86



PUJ/MD10
PAGE 89

+ APPLICATION

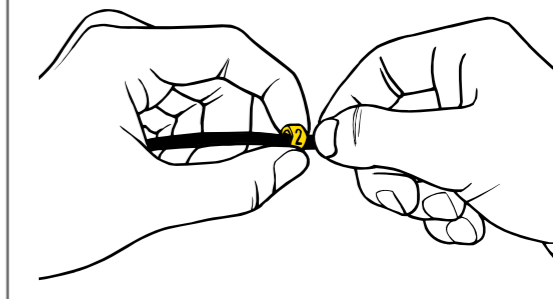



+ INFORMATION

- + Open markers for already connected wires
- + Securely positioned with help of barbs
- + Twist-protected for secure combination marking
- + Fast snap installation.

+ PROPERTIES

Temperature range
-30°C to +60°C

Material
PVC

Print
hot stamped

Standard colours
yellow and white
international colour code for 0-9

Text
0-9, A-Z, + - / : ~ ±

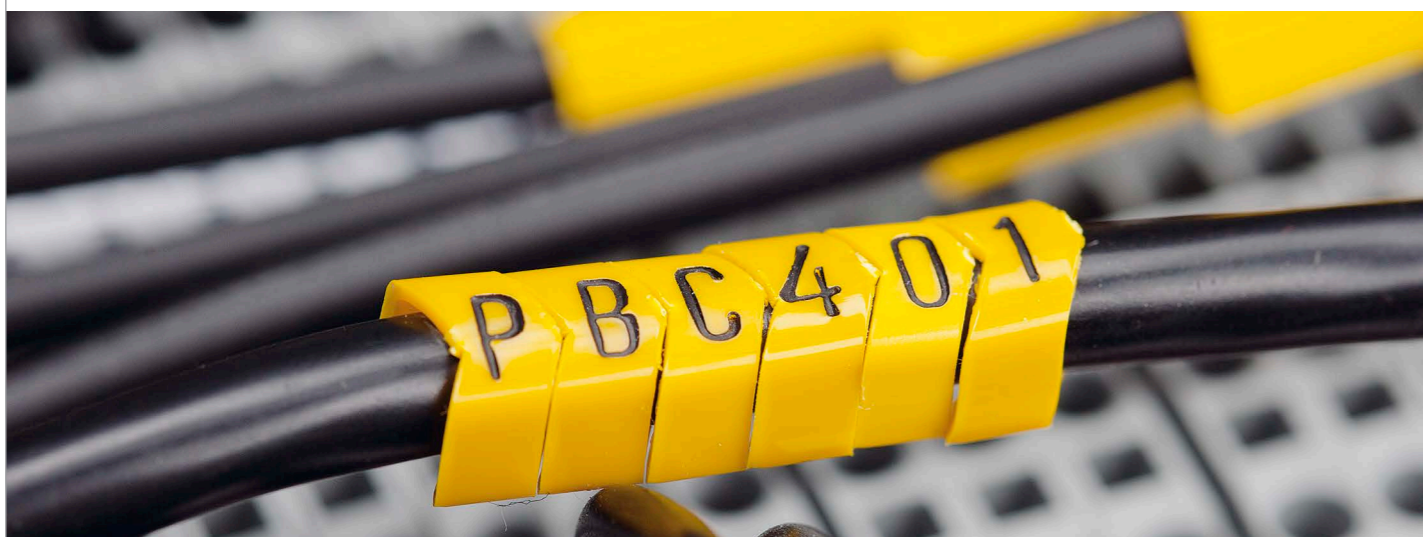

+ DIMENSIONS

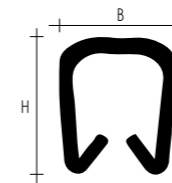

TYPE	HEIGHT (H mm)	WIDTH (B mm)	HEIGHT TEXT (mm)
PC-10	3.6	3.7	2.6
PC-20	4.2	4.5	2.6
PC-30	5.5	5.7	2.6
PC-40	6.5	6.9	4.0

+ SIZES AND PACKAGING

TYPE	CABLE DIAMETER	LENGTH	NUMBER OF CHARACTERS	PACKAGING
PC-10	~2.4 - 3.0 mm ~0.5 - 1.5 mm ²	3 mm	1	1000 piece multi pack
PC-20	~3.0 - 4.0 mm ~1.5 - 2.5 mm ²	3 mm	1	1000 piece multi pack
PC-30	~4.0 - 5.0 mm ~2.5 - 4.0 mm ²	3 mm	1	1000 piece multi pack
PC-40	~5.0 - 6.2 mm ~4.0 - 6.0 mm ²	4 mm	1	1000 piece multi pack

* Size shown refers to BS6231 tri-rated cable

+ APPLICATION

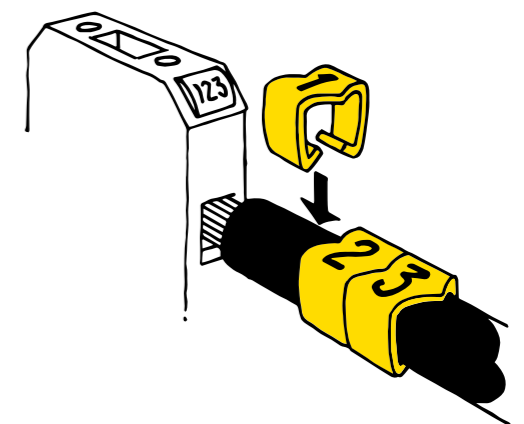



+ INFORMATION

- + Open markers for already connected wires
- + Designed to interlock when fitted enabling easy alignment of multi digit markings.
- + Two sizes cover all cable sizes from 0.5 to 4.0 mm².

+ PROPERTIES

Temperature range
-30°C to +100°C

Material
Halogen-free Polyamide 6.6

Print
hot stamped

Standard colours
black on white, or black on yellow
international colour codes 0-9

Text
0-9, A-Z, + - / : ~ ±, or blank

Properties
Excellent resistance to petrol, oils and fats.

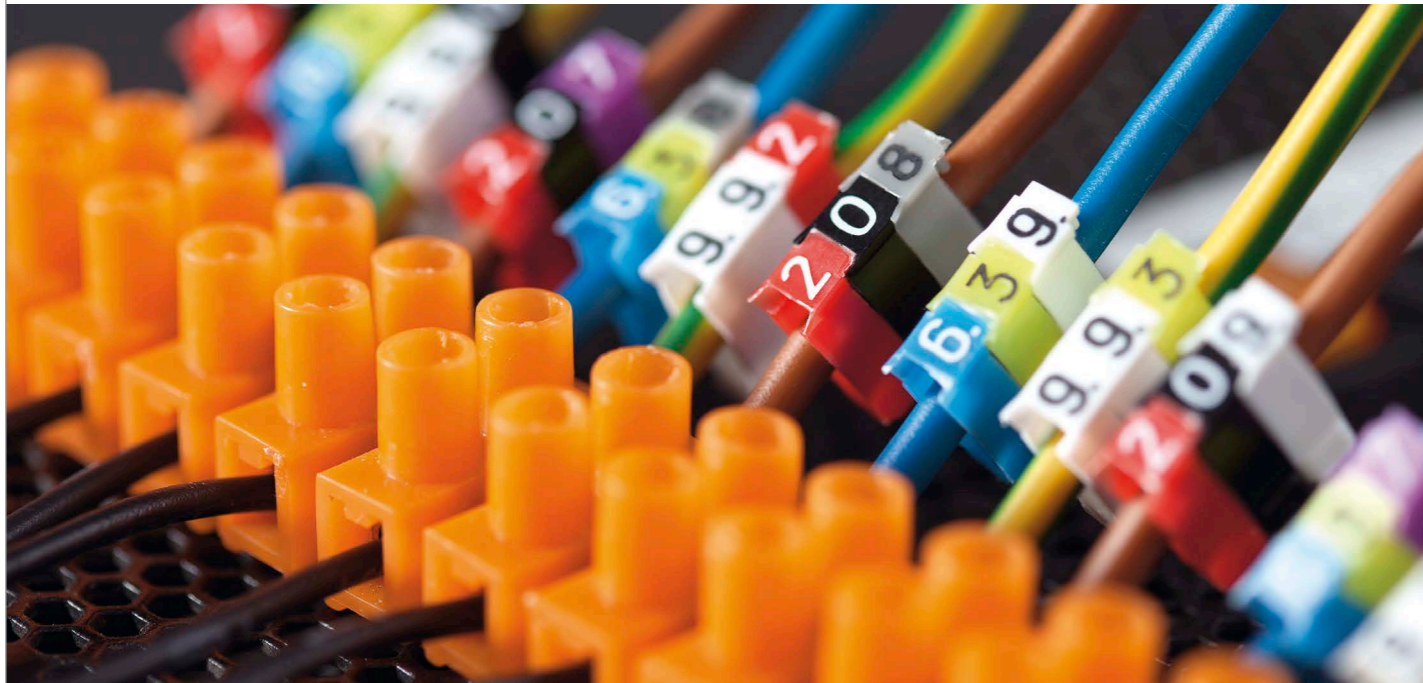

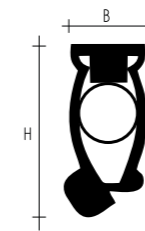

+ DIMENSIONS



TYPE	HEIGHT (H mm)	WIDTH (B mm)	HEIGHT TEXT (mm)
PCA1	9.5	5.0	3.0
PCA2	13.0	5.0	3.0

+ SIZES AND PACKAGING

TYPE	DIAMETER / CABLE SIZE*	LENGTH	NUMBER OF CHARACTERS	PACKAGING
PCA1	2.2 - 3.6 mm 0.5, 0.75, 1.0, or 1.5 mm ²	4 mm	1	 pack of 320 pcs (10 strips of 32 markers)
PCA2	3.6 - 6.0 mm 2.5 or 4.0 mm ²	4 mm	1	 pack of 320 pcs (10 strips of 32 markers)

* Size shown refers to BS6231 tri-rated cable

+ APPLICATION

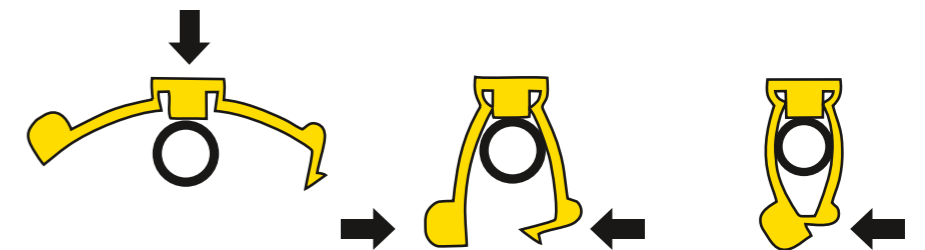



+ INFORMATION

- + Combination marker for cable and pipe marking
- + One size for all diameters
- + Installed quickly onto Partex PKH or POH holder which is fastened with cable ties around the cable
- + Entirely closed and twist-protected
- + Highly durable in exposed environments and with excellent readability

+ PROPERTIES

Temperature range

PK+: -30°C to +60°C
PKZ: -30°C to +90°C

Material

PK+: PVC
PKZ: ZEREX

Print

PK+: hot stamped, PKZ: ink

Standard colours

yellow and white and the international colour code for 0-9

Text

0-9, A-Z, +, -, /, ~, ↓

+ APPLICATION

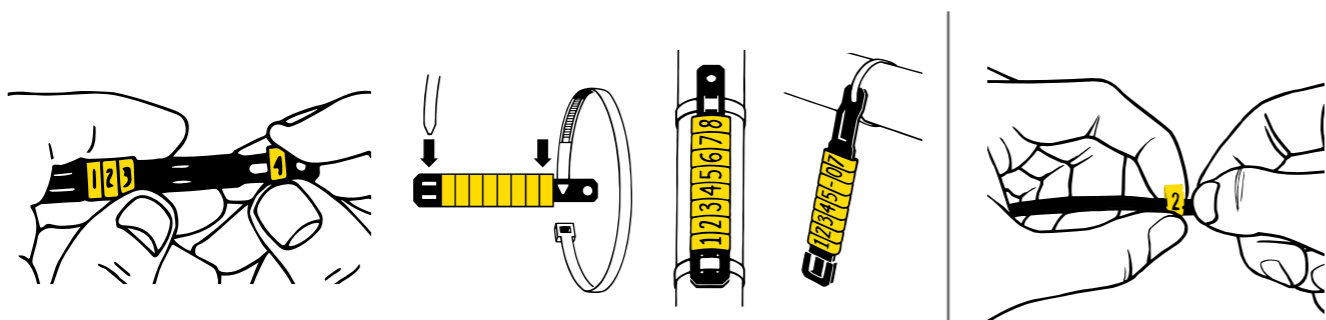

+ RELATED PRODUCTS



HFC
PAGE 95



POH



PKH

+ DIMENSIONS

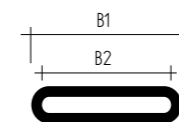

TYPE	WIDTH (B1 mm)	WIDTH (B2 mm)	HEIGHT TEXT (mm)
PK+/PKZ2	11.3	10.0	4.0

+ ACCESSORIES

PRODUCT	LENGTH	MAX. QUANTITY PK-2	MAX. QUANTITY PKZ2	PACKAGING
PKH070	70 mm	10	-	pack of 100 pcs
PKH070POL	70 mm	10	7	pack of 100 pcs
PKH100POL	100 mm	20	13	pack of 100 pcs
POH07	60 mm	8	-	pack of 100 pcs
POH12	82 mm	13	-	pack of 100 pcs
POH18	110 mm	19	-	pack of 100 pcs
POH30	150 mm	30	-	pack of 100 pcs

+ SIZES AND PACKAGING

TYPE	LENGTH	NUMBER OF CHARACTERS	PACKAGING
PK+/PKZ2	4 mm	1	pack of 5x100 pcs - cut
PK+/PKZ2	4 mm	1	compact disc 500 pcs

PKH are available in black only, POH are available in black, white and yellow (other colours on request)



MULTI CHARACTER MARKERS

M2

CUSTOMIZED MULTI CHARACTER MARKERS

SAVING. Customized multi-character marking increases efficiency. The more complex the job, the greater the potential time saving. Furthermore, there is no waste. Ordering the markers ready-sorted saves even more time.

SIMPLICITY. We have also made it easy to order M2 markers. Simply choose the method that suits you best. Anything from an emailed Excel list to direct ordering via the internet, using MarkOnLine. - order when, where and how you like. It could not be any simpler!

SAFETY. Using our M2 system ensures the highest quality and accuracy. A correct original specification guarantees a correct end result. This is because all the markers are printed in advance!

SELECTION. Our M2 system leaves you entirely free to adapt your marking to your needs. Product types, sizes, colours, materials, sorting methods, packaging - we understand our customers needs and can offer the widest possible selection of solutions.

ONLINE ORDERING. Design your own customised markers online with our easy to use website: <https://markonline.partex.co.uk>



SORTING AND PACKAGING OPTIONS FOR OUR CUSTOMIZED MULTI CHARACTER MARKERS

- MFS10** - The same type of markers sorted on a roll or in a bag.
- MFS20** - Various types of markers sorted in one bag. Sorted for example according to drawing, cabinet or cables.
- MFS30** - „Double Sorting“, eg the cabinet, inside cabinets - by individual cables. Markers can also be ordered on adhesive tape or a sheet.
- MFS40** - Markers mounted with cable ties and holders (PKH), sorted on a sheet or adhesive tape.





+ INFORMATION

- + Multi-character markers printed according to customer specifications
- + All of information on one sleeve
- + Quick installation with fewer markers
- + No residue, no need of inventory

+ OPEN WIRE MARKERS

TYPE	DIAMETER [mm]	AREA [mm ²]	LENGTH [mm]	NUMBER OF CHARACTERS
PC/PCZ-10	2.4 - 3.0	0.5 - 1.5	9 - 100	1 - 30
PC/PCZ-20	3.0 - 4.0	1.5 - 2.5	9 - 100	1 - 30
PC/PCZ-30	4.0 - 5.0	2.5 - 4.0	9 - 100	1 - 30
PC/PCZ-40	5.0 - 6.2	4.0 - 6.0	9 - 100	1 - 30

+ CLOSED WIRE MARKERS

TYPE	DIAMETER [mm]	AREA* [mm ²]	LENGTH [mm]	NUMBER OF CHARACTERS
PA+00	0.8-2.0		9 - 100	1-30
PA+02	1.3 - 3.0	0.5 - 0.75	9 - 100	1 - 30
PA+1	2.5 - 5.0	0.75 - 4.0	9 - 100	1 - 30
PA+2	4.0 - 10.0	2.5 - 10.0	9 - 100	1 - 30
PA+3	8.0 - 16.0	16.0 - 50.0	9 - 100	1 - 30

* Size shown refers to BS6231 tri-rated cable.

+ CABLE MARKERS

TYPE	LENGTH [mm]	NUMBER OF CHARACTERS
PK+/PKZ2	9 - 100	1 - 30
PK+/PKZ20QT25	25	12
PK+/PKZ20QT40	40	40

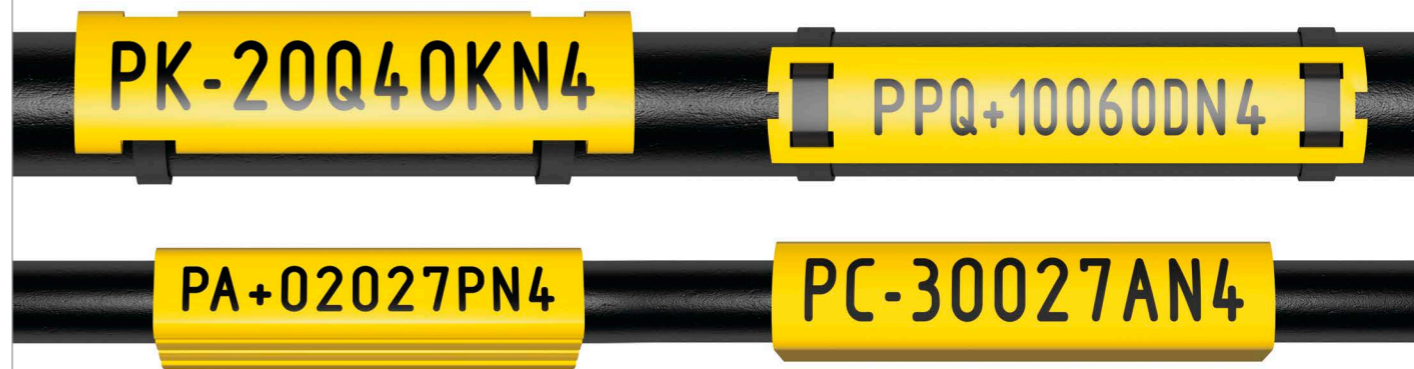

+ CUSTOMISED MULTI-CHARACTER MARKING, PA

TYPE	DIAMETER [mm]	AREA* [mm ²]	MARKER TEXT	PACKAGING
PA+02	1.3 - 3.0	0.5 - 0.75	L1, L2, L3, PE	strip pack 5x100 pcs compacta disc 250 pcs reel 1000 pcs
PA+1	2.5 - 5.0	0.75 - 4.0	L1, L2, L3, PE	strip pack 5x100 pcs compacta disc 250 pcs reel 1000 pcs
PA+2	4.0 - 10.0	2.5 - 10.0	L1, L2, L3, PE	strip pack 5x100 pcs compacta disc 250 pcs reel 1000 pcs
PA+3	8.0 - 16.0	16.0 - 50.0	L1, L2, L3, PE	strip pack 5x20 pcs

* Size shown refers to BS6231 tri-rated cable.

+ CUSTOMISED MULTI-CHARACTER MARKING, PC

TYPE	DIAMETER [mm]	AREA [mm ²]	MARKER TEXT	PACKAGING
PC-10	2.4 - 3.0	0.5 - 1.5	L1, L2, L3, PE	strip pack 5x100 pcs
PC-20	3.0 - 4.0	1.5 - 2.5	L1, L2, L3, PE	strip pack 5x100 pcs
PC-30	4.0 - 5.0	2.5 - 4.0	L1, L2, L3, PE	strip pack 5x100 pcs
PC-40	5.0 - 6.2	4.0 - 6.0	L1, L2, L3, PE	strip pack 5x100 pcs

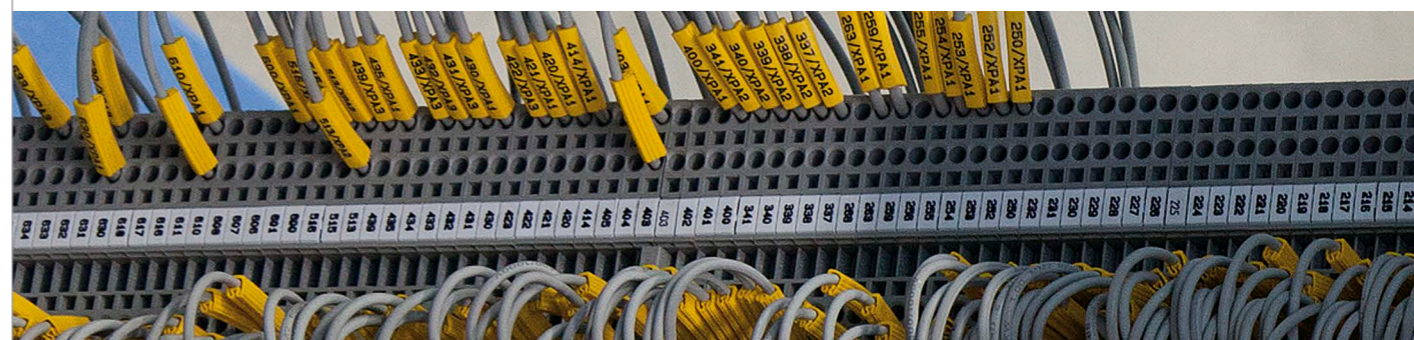



+ INFORMATION

- + Oval profile to identify cables and wires
- + Quick installation - all information included on one sleeve
- + Designed for the most popular sizes of wires and cables
- + Easy to print onto with thermal transfer printers from Partex.
- + PO-068 can be applied directly onto the POH or PKH carriers and then fastened to the cable with cable ties.

+ PROPERTIES

Temperature range

PO: -30°C to +60°C; POZ: -30°C to +90°C

Material

PO - PVC, POZ - ZEREX

Print

thermal transfer

Standard colours

yellow and white, others available on request

+ RELATED PRODUCTS



PROMARK-T1000
PAGE 100



MK10
PAGE 106



MK10-DH
PAGE 108



PKH
PAGE 23



POH
PAGE 23

+ APPLICATION

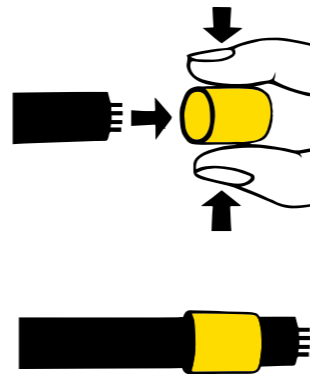

+ DIMENSIONS AND PACKAGING

TYPE	TYPE - (ZERO HALOGEN)	DIAMETER [mm] [min/max]	AREA* [mm²]	PACKAGING	COMPATIBLE PRINTERS
PO-01	POZ-01	13 / 18		6 m / 250 m	PROMARK-T1000 MK10, MK10-DH
PO-02	POZ-02	17 / 22		5 m / 60 m / 250 m	
PO-03	POZ-03	20 / 25		4.5 m / 50 m / 250 m	
PO-04	POZ-04	22 / 28	0.5	4.5 m / 50 m / 200 m	
PO-05	POZ-05	27 / 35	0.75-1.0	4 m / 40 m / 200 m	
PO-06	POZ-06	32 / 4.0	15-25	3.5 m / 40 m / 200 m	
PO-068*	PKZ20	6.8 / 7.0	-	4.5 m / 50 m	
PO-06Q**	-	-	-	3.5 m / 40 m	
PO-068Q**	PKZ20Q	-	-	25 m / 50 m	
PO-07	POZ-07	3.8 / 4.7	4.0	3.5 m / 30 m / 100 m	
PO-08	POZ-08	4.6 / 5.5	6.0	3 m / 30 m / 100 m	
PO-09	POZ-09	5.6 / 7.0	10.0	50 m	
PO-10	POZ-10	6.5 / 8.0	16.0		

* mounted on POH, PKH or directly with cable tie ** pre-punched, mounted with cable tie

Size shown refers to BS6231 tri-rated cable



+ PO - WIRE AND CABLE MARKERS

TYPE	DIAMETER (min/max) [mm]	AREA** [mm ²]
PO/POZ-01	13/18	
PO/POZ-02	17/22	
PO/POZ-03	20/25	
PO/POZ-04	2.2/2.8	05
PO/POZ-05	2.7/3.5	0.75-1.0
PO/POZ-06	3.2/4.0	15-2.5
PO/POZ-068*	6.8/7.0	-
PO/POZ-07	3.8/4.7	4.0
PO/POZ-08	4.6/5.5	6.0
PO/POZ-09	5.6/7.0	10.0
PO/POZ-10	6.5/8.0	16.0
PO/POZ-12	7.5/10.0	20.0
PO/POZ-14	9.5/12.0	25.0
PO/POZ-16	11.5/14.0	35.0
PO/POZ-18	13.5/16.0	50.0
PO/POZ-20	15.5/18.0	70.0
PO/POZ-22	17.5/20.0	95.0
PO/POZ-24	19.5/22.0	120.0
PO/POZ-26	21.5/24.0	150.0
PO/POZ-28	24.0/28.0	185.0

* Mountable on POH and PKH carriers

** Size shown refers to BS6231 tri-rated cable

+ PACKAGING



UN SORTED

Your customised markers can be sorted and packaged however you require



ON A REEL / IN A BAG

+ PHZ - HEAT SHRINK

TYPE	DIAMETER BEFORE SHRINKING [mm]	DIAMETER AFTER SHRINKING [mm]
PHZ/PHZF20024	2.4	1.2
PHZ/PHZF20032	3.2	1.6
PHZ/PHZF20048	4.8	2.4
PHZ/PHZF20064	6.4	3.2
PHZ/PHZF20095	9.5	4.8
PHZ/PHZF20127	12.7	6.4
PHZ/PHZF20190	19.0	9.5
PHZ/PHZF20254	25.4	12.7
PHZ/PHZF20320	32.0	16.0

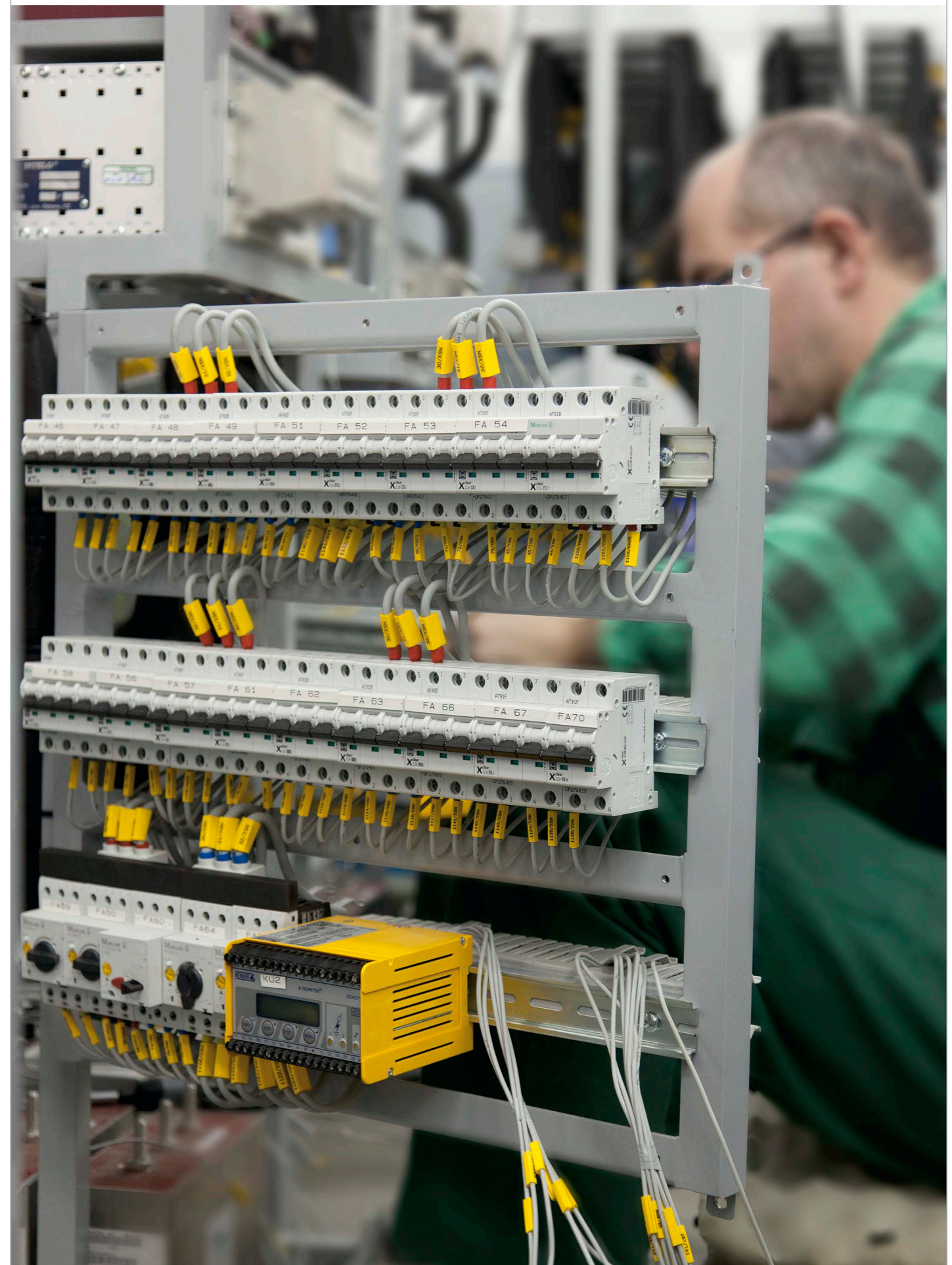



+ INFORMATION

- + Flexible, round profile made of cross-linked heat shrinkable polyolefin.
- + Many applications in industry
- + Excellent properties and fire safety characteristics
- + Low smoke generation and evolution of acid gases
- + 2:1 shrink ratio

+ PROPERTIES

Temperature range
-55°C to +125°C

Material
polyolefin, flame retardant in accordance with ASTM D2671

Print
thermal transfer

Standard colours
yellow and white, other colours available on request

According to the standard
AMS-DTL-23053 Class 1
BS 6853:1999
CEN/TS 45545-2
UNI CEI 11170-3



+ DIMENSIONS AND PACKAGING

TYPE	DIAMETER (D mm)	DIAMETER (D1 mm)	THICKNESS (W mm)	PACKAGING	COMPATIBLE PRINTERS
PHZ20024	2.4	12	0.51	15 m or 100 m	PROMARK-T1000
PHZ20032	3.2	16	0.51	15 m or 100 m	
PHZ20048	4.8	2.4	0.51	12 m or 100 m	
PHZ20064	6.4	3.2	0.64	12 m or 100 m	
PHZ20095	9.5	4.8	0.64	75 m	MK-10, MK10-DH
PHZ20127	12.7	6.4	0.64	50 m	
PHZ20190	19.0	9.5	0.77	25 m	
PHZ20254	25.4	12.7	0.89	25 m	
PHZ20381	38.1	19.1	1.02	25 m	

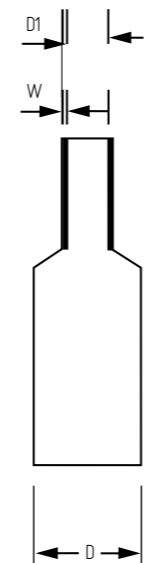

+ RELATED PRODUCTS



+ APPLICATION

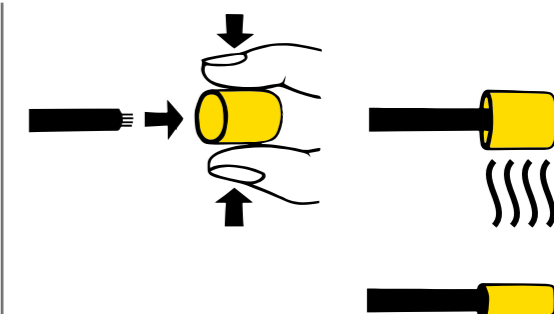



+ INFORMATION

- + Flat, thin-walled heat shrink made of halogen-free material.
- + High resistance to low and high temperature.
- + Very low gas emission in the event of fire.
- + Flame resistant.
- + 2:1 shrink ratio.
- + Ideal for heavy-duty industrial applications.
- + Fast and cheap marking on site with a printer from Partex.

+ PROPERTIES

Temperature range
-55°C do +125°C

Material
Halogen free, self-extinguishing in accordance with ASTM D2671

Print
thermal transfer

Standard colours
yellow and white, other colours available on request

According to standard
AMS-DTL-23053 Class 1

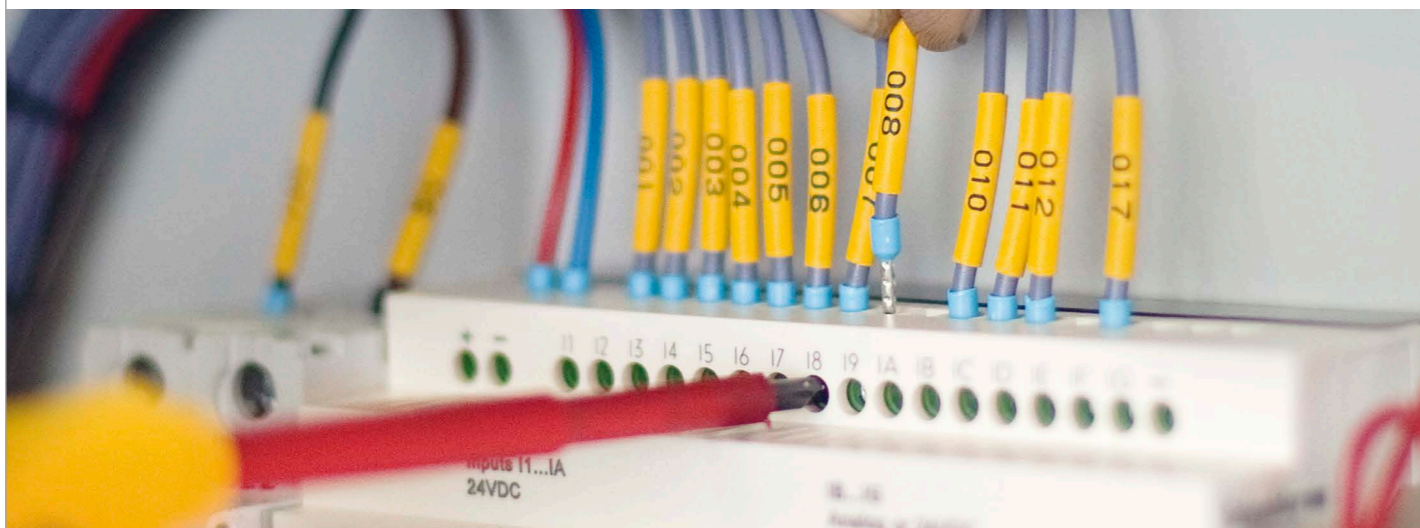

+ DIMENSIONS AND PACKAGING

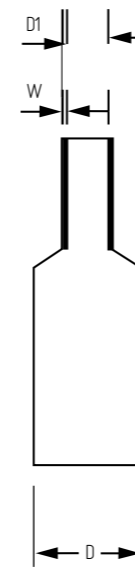

TYPE	DIAMETER (D mm)	DIAMETER (D1 mm)	THICKNESS (W mm)	PACKAGING	COMPATIBLE PRINTERS
PHZF20024	2.4	12	0.51	25 m or 100 m	PROMARK-T1000
PHZF20032	3.2	16	0.51	25 m or 100 m	
PHZF20048	4.8	24	0.51	25 m or 100 m	
PHZF20064	6.4	32	0.64	25 m or 100 m	
PHZF20095	9.5	4.8	0.64	75 m	MK-10, MK10-DH
PHZF20127	12.7	6.4	0.64	50 m	
PHZF20191	19.1	9.5	0.77	50 m	
PHZF20254	25.4	12.7	0.89	50 m	
PHZF20381	38.1	19.1	1.02	25 m	

+ RELATED PRODUCTS



+ APPLICATION

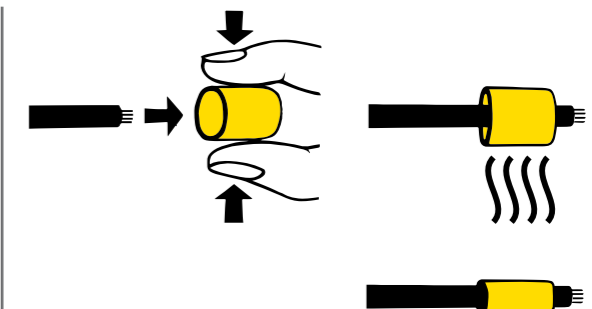



+ INFORMATION

SG - Standard Grade Printable Heat Shrink Sleeves

Very flexible heat shrinkable tubing (2:1 shrink ratio). Flexible polyolefin sleeves used for wire identification. Markers are supplied roll form in a flattened format on a backing which can also be printed to aid sorting.

- + Flame Retardant
- + Self Extinguishing
- + Easy Pick Application
- + Backing card perforated after every sleeve
- + RoHS and REACH Compliant

+ SPECIFICATIONS

Temperature range
-55°C to +125°C

Material
flexible polyolefin

Print
thermal transfer

Standard colours
yellow and white

Shrink ratio
2:1

Certified and issued to:
UL224 VW-1 Flammability

+ PROPERTIES

PROPERTY	VALUE
Continuous Operating Temperature	-55°C to +125°C
Tensile Strength	10.4 MPa Min.
Elongation at Break	250% Min.
Optimum Shrink Temperature	+115°C
Longitudinal Change	-7% Max.
Dielectric Strength	20kV per 1mm wall thickness
Minimum Shrink Temperature	+90°C

+ RELATED PRODUCTS



MK10
PAGE 106



MK10-DH
PAGE 108



EOS1
PAGE 104

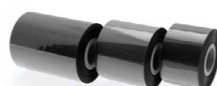

RIBBONS
PAGE 81

**PROSLEEVE - SG
STANDARD GRADE**

+ PRODUCT RANGE

TYPE	DIAMETER (mm) BEFORE SHRINKING	DIAMETER (mm) AFTER SHRINKING	SLEEVE LENGTH (mm)	MARKERS ACROSS	MARKERS / BOX
SG^024125LR*	2.4	12	12.5	4	4000
SG^024250LR*	2.4	12	25	2	2000
SG^024500LR*	2.4	12	50	1	1000
SG^032125LR*	3.2	16	12.5	4	4000
SG^032250LR*	3.2	16	25	2	2000
SG^032500LR*	3.2	16	50	1	1000
SG^048125LR*	4.8	24	12.5	4	4000
SG^048250LR*	4.8	24	25	2	2000
SG^048500LR*	4.8	24	50	1	1000
SG^064125LR*	6.4	32	12.5	4	4000
SG^064250LR*	6.4	32	25	2	2000
SG^064500LR*	6.4	32	50	1	1000
SG^095125LR*	9.5	47.5	12.5	4	2000
SG^095250LR*	9.5	47.5	25	2	1000
SG^095500LR*	9.5	47.5	50	1	500
SG^127125LR*	12.7	64	12.5	4	2000
SG^127250LR*	12.7	64	25	2	1000
SG^127500LR*	12.7	64	50	1	500
SG^180125LR*	18.0	90	12.5	4	2000
SG^180250LR*	18.0	90	25	2	1000
SG^180500LR*	18.0	90	50	1	500
SG^254250LR*	25.4	127	25	2	600
SG^254500LR*	25.4	127	50	1	300
SG^381500LR*	38.1	191	50	1	100
SG^508500LR*	50.8	254	50	1	100

^ = S (single sided), D (double sided); * = Colour (4=Yellow, 9=White)
Recommended ribbon: 2020 series



+ INFORMATION

MS - Military Specification Printable Heat Shrink Sleeves

Very flexible, high temperature rated, highly flame retardant, UL and CSA recognised heat shrinkable tubing (3:1 shrink ratio). Flexible polyolefin sleeves used for wire identification. Markers are supplied roll form in a flattened format on a carrier which can also be printed to aid sorting.

- + Flame Retardant
- + Self Extinguishing
- + Meets requirements of SAE-DTL-23053/5
- + Easy Pick Application
- + Backing card perforated after every sleeve
- + Print performance to Military Specifications
- + RoHS and REACH Compliant

+ SPECIFICATIONS

Temperature range
-55°C to +135°C

Material
flexible polyolefin

Print
thermal transfer

Standard colours
yellow and white

Shrink ratio
3:1

Certified and issued to:
SAE-AMS-DTL-23053/5
UL224 VW-1 Flammability

Print performance to military specifications
Adherence: SAE-AS5942
Fluid Resistance: MIL202G Method 215K

+ PROPERTIES

PROPERTY	VALUE
Continuous Operating Temperature	-55°C to +135°C
Elongation After Heat Ageing 158°Cx168h)	100% Min.
Heat Shock (250°Cx4h)	Pass no crack, flowing or dripping
Min. Shrink Temp for full Recovery	+90°C
Longitudinal Change	-15% Max.
Tensile Strength	10.4 MPa Min.
Elongation at Break	200% Min.
Secant Modulus	173 MPa Max.
Flammability	UL 224 VW1
Voltage Rating	600V

+ RELATED PRODUCTS



MK10
PAGE 106



MK10-DH
PAGE 108



EOS1
PAGE 104

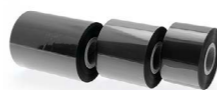

RIBBONS
PAGE 81

PROSLEEVE - MS
MILITARY SPECIFICATION

+ PRODUCT RANGE

TYPE	DIAMETER (mm) BEFORE SHRINKING	DIAMETER (mm) AFTER SHRINKING	SLEEVE LENGTH (mm)	MARKERS ACCROSS	MARKERS / BOX
MS^024125LR*	2.4	0.8	12.5	4	4000
MS^024250LR*	2.4	0.8	25	2	2000
MS^024500LR*	2.4	0.8	50	1	1000
MS^032125LR*	3.2	1.10	12.5	4	4000
MS^032250LR*	3.2	1.10	25	2	2000
MS^032500LR*	3.2	1.10	50	1	1000
MS^048125LR*	4.8	1.6	12.5	4	4000
MS^048250LR*	4.8	1.6	25	2	2000
MS^048500LR*	4.8	1.6	50	1	1000
MS^064125LR*	6.4	2.10	12.5	4	4000
MS^064250LR*	6.4	2.10	25	2	2000
MS^064500LR*	6.4	2.10	50	1	1000
MS^095125LR*	9.5	3.2	12.5	4	2000
MS^095250LR*	9.5	3.2	25	2	1000
MS^095500LR*	9.5	3.2	50	1	500
MS^127125LR*	12.7	4.2	12.5	4	2000
MS^127250LR*	12.7	4.2	25	2	1000
MS^127500LR*	12.7	4.2	50	1	500
MS^180125LR*	18.0	6.4	12.5	4	2000
MS^180250LR*	18.0	6.4	25	2	1000
MS^180500LR*	18.0	6.4	50	1	500
MS^254250LR*	25.4	8.5	25	2	600
MS^254500LR*	25.4	8.5	50	1	300
MS^381500LR*	38.1	12.7	50	1	100

^ = S (single sided), D (double sided); * = Colour (4=Yellow, 9=White)
Recommended ribbon: 2020 serie s



+ INFORMATION

HF - Halogen Free Printable Heat Shrink Sleeves

Very flexible, low smoke, zero halogen and flame retardant heat shrinkable tubing (2:1 shrink ratio). Flexible polyolefin sleeves used for wire identification. Offers excellent fire safety characteristics combined with minimal smoke emissions

- + Flame Retardant to UL224 VW-1
- + Low Smoke
- + Zero Halogen
- + Easy Pick Application
- + Backing card perforated after every sleeve
- + Print performance to Military Specifications
- + RoHS and REACH Compliant

+ SPECIFICATIONS

Temperature range
-30°C to +105°C

Material
flexible polyolefin

Print
thermal transfer

Standard colours
yellow and white

Shrink ratio
2:1

Certified and issued to:
UL224 VW-1 Flammability

Print performance to military specifications
Adherence: SAE-AS81531-1998 Clause 4.6.2
Fluid Resistance: MIL202 Method 215K

+ PROPERTIES

PROPERTY	VALUE
Continuous Operating Temperature	-30°C to +105°C
Elongation After Heat Ageing (150°C x 168h)	250% Min.
Heat Shock (225°C x 4h)	No cracking, flowing or dripping
Min. Shrink Temp for full Recovery	+90°C
Longitudinal Change	+5%, -10% Max.
Tensile Strength	13.0 MPa Min.
Elongation at Break	400% Min.
Oxygen Index	36%
Dielectric Strength	20kV/mm
Volume Resistivity	1014 ohm cm

+ RELATED PRODUCTS



MK10
PAGE 106



MK10-DH
PAGE 108



EOS1
PAGE 104



RIBBONS
PAGE 81

PROSLEEVE - HF
HALOGEN FREE

+ PRODUCT RANGE

TYPE	DIAMETER (mm) BEFORE SHRINKING	DIAMETER (mm) AFTER SHRINKING	SLEEVE LENGTH (mm)	MARKERS ACCROSS	MARKERS / BOX
HF^024125LR*	2.4	12	12.5	4	4000
HF^024250LR*	2.4	12	25	2	2000
HF^024500LR*	2.4	12	50	1	1000
HF^032125LR*	3.2	16	12.5	4	4000
HF^032250LR*	3.2	16	25	2	2000
HF^032500LR*	3.2	16	50	1	1000
HF^048125LR*	4.8	24	12.5	4	4000
HF^048250LR*	4.8	24	25	2	2000
HF^048500LR*	4.8	24	50	1	1000
HF^064125LR*	6.4	32	12.5	4	4000
HF^064250LR*	6.4	32	25	2	2000
HF^064500LR*	6.4	32	50	1	1000
HF^095125LR*	9.5	47.5	12.5	4	2000
HF^095250LR*	9.5	47.5	25	2	1000
HF^095500LR*	9.5	47.5	50	1	500
HF^127125LR*	12.7	64	12.5	4	2000
HF^127250LR*	12.7	64	25	2	1000
HF^127500LR*	12.7	64	50	1	500
HF^190125LR*	19.0	95	12.5	4	2000
HF^190250LR*	19.0	95	25	2	1000
HF^190500LR*	19.0	95	50	1	500
HF^254250LR*	25.4	127	25	2	600
HF^254500LR*	25.4	127	50	1	300
HF^381500LR*	38.1	191	50	1	100
HF^508500LR*	50.8	254	50	1	100

^ = S (single sided), D (double sided); * = Colour (4=Yellow, 9=White)
Recommended ribbon: 2020 or 510 series



+ INFORMATION

NF - Diesel Resistant Printable Heat Shrink Sleeves

Very flexible, high temperature rated, highly flame retardant, UV Stabilised heat shrinkable tubing (3:1 shrink ratio). Ideally suited for applications where resistance to organic fluids, common fuels, lubricants and solvents are required. Flexible polyolefin sleeves used for wire identification. Markers are supplied roll form in a flattened format on a backing which can also be printed to aid sorting.

- + Diesel Resistant
- + Flame Retardant
- + Self Extinguishing
- + Meets SNCF Spec. NF-F00-608
- + Easy Pick Application
- + Backing card perforated after every sleeve
- + Print performance to Military Specifications
- + RoHS and REACH Compliant

+ SPECIFICATIONS

Temperature range
-55°C to +135°C

Material
flexible polyolefin

Print
thermal transfer

Standard colours
yellow and white

Shrink ratio
3:1

Certified and issued to:
UL224 @ 300V

Print performance to military specifications
Adherence: SAE-AMS-DTL-23053-6 Class 1

+ PROPERTIES

PROPERTY	VALUE
Continuous Operating Temperature	-55°C to +135°C
Min. Shrink Temp for full Recovery	130°C (starts at 100°C)
Heat Shock (250°Cx4h)	Pass no crack, flowing or dripping
Longitudinal Change	+10% Max.
Tensile Strength	13.8 MPa Min.
Elongation at Break	200% Min.
Diesel Oil Resistance	NF F00-608
Secant Modulus	172 MPa Max.
Flammability	Flame retarded 60 sec Max. ASTM-D2671 (B)

+ RELATED PRODUCTS



MK10
PAGE 106



MK10-DH
PAGE 108



EOS1
PAGE 104



RIBBONS
PAGE 81

**PROSLEEVE - NF
DIESEL SPECIFICATION**

+ PRODUCT RANGE

TYPE	DIAMETER (mm) BEFORE SHRINKING	DIAMETER (mm) AFTER SHRINKING	SLEEVE LENGTH (mm)	MARKERS ACROSS	MARKERS / BOX
NF^032125LR*	3.2	110	12.5	4	4000
NF^032250LR*	3.2	110	25	2	2000
NF^032500LR*	3.2	110	50	1	1000
NF^048125LR*	4.8	16	12.5	4	4000
NF^048250LR*	4.8	16	25	2	2000
NF^048500LR*	4.8	16	50	1	1000
NF^064125LR*	6.4	210	12.5	4	4000
NF^064250LR*	6.4	210	25	2	2000
NF^064500LR*	6.4	210	50	1	1000
NF^095125LR*	9.5	3.2	12.5	4	2000
NF^095250LR*	9.5	3.2	25	2	1000
NF^095500LR*	9.5	3.2	50	1	500
NF^127125LR*	12.7	4.2	12.5	4	2000
NF^127250LR*	12.7	4.2	25	2	1000
NF^127500LR*	12.7	4.2	50	1	500
NF^180125LR*	18.0	6.4	12.5	4	2000
NF^180250LR*	18.0	6.4	25	2	1000
NF^180500LR*	18.0	6.4	50	1	500
NF^254250LR*	25.4	8.5	25	2	600
NF^254500LR*	25.4	8.5	50	1	300
NF^381500LR*	38.1	12.6	50	1	100
NF^508500LR*	50.8	16.9	50	1	100

^ = S (single sided), D (double sided); * = Colour (4=Yellow, 9=White)
Recommended ribbon: 2020 series



+ INFORMATION

EF - Extended Fire Resistant Printable Heat Shrink Sleeves

Flame retardant, zero halogen, low smoke, low toxicity radiation cross linked UV stabilised and printable polyolefin sleeves used for wire identification. Ideal for use where limited fire hazard properties are required. Developed for use in mass transit, and marine applications where human life is at risk. Meets London Underground Limited Standard 1-085.

- + Flame Retardant
- + Self Extinguishing
- + Zero Halogen
- + Easy Pick Application
- + Backing card perforated after every sleeve
- + Print performance to Military Specifications
- + RoHS and REACH Compliant

+ SPECIFICATIONS

Temperature range -40°C to +105°C	Standard colours yellow and white	Specifications: Meets DEF STAN 59-97, issue 3 type 8 LUL Standard 1-085 (Limited, dispersed usage) Formerly LUL 2-01001-002 BS6583 - Vehicle Cat. 1a
Material flexible polyolefin	Shrink ratio 2:1	
Print thermal transfer	Fluid resistance Meets: MIL202G Method 215K	

+ PROPERTIES

Thermal Properties	Value	Test Method
Continuous Operating Temperature	-40°C to +105°C	-
Elongation After Heat Ageing (158°Cx16hrs)	150%	ISO 37
Cold Bend (-40°C)	Does not break	ASTM-D 2671 Meth. C
Elongation After Heat Shock (150°Cx4hrs)	100% Min.	ASTM-D 2671
Minimum Shrink Temperature	+115°C	ASTM-D 2671
Flammability	Flame retardant	ASTM-D 635

Physical Properties	Value	Test Method
Longitudinal Change	+/-10% Max.	ASTM-D 2671
Specific Gravity	1.45 g/cm ³	ISO/R 1183
Tensile Strength	10.0 MPa Min.	IEC 60684-2
Elongation at Break	200% Min.	IEC 60684-2
Secant Modulus	130 MPa Max.	ASTM-D 882

Chemical Properties	Value	Test Method
Chemical Resistance	Good to Excellent	-
Corrosion Action	Non-Corrosive	ASTM-D 2671 Meth. A
Copper Compatibility	Non-Corrosive	ASTM-D 2671

Electrical Properties	Value	Test Method
Dielectric Strength	24kV/mm	IEC 243
Volume Resistivity	61 ⁶ ohmxcmm	ASTM-D 2671 Meth. A
Dielectric Voltage Withstand (after aging)	No Breakdown	ASTM-D 2671
Water Absorption	0.20%	ASTM-D 570

Low Fire Hazard Properties	Value	Test Method
Oxygen Index	32	ISO 4589-2
Toxicity (R Value)	0.31	BS6853 B1
Smoke Emission (Ao)	0.014	BS6853 D8.3

PROSLEEVE - EF
EXTENDED FIRE SPECIFICATION

+ PRODUCT RANGE

TYPE	DIAMETER (mm) BEFORE SHRINKING	DIAMETER (mm) AFTER SHRINKING	SLEEVE LENGTH (mm)	MARKERS ACCROSS	MARKERS / BOX
EF^024125LR*	2.4	12	12.5	4	4000
EF^024250LR*	2.4	12	25	2	2000
EF^024500LR*	2.4	12	50	1	1000
EF^032125LR*	3.2	16	12.5	4	4000
EF^032250LR*	3.2	16	25	2	2000
EF^032500LR*	3.2	16	50	1	1000
EF^048125LR*	4.8	24	12.5	4	4000
EF^048250LR*	4.8	24	25	2	2000
EF^048500LR*	4.8	24	50	1	1000
EF^064125LR*	6.4	32	12.5	4	4000
EF^064250LR*	6.4	32	25	2	2000
EF^064500LR*	6.4	32	50	1	1000
EF^095125LR*	9.5	47.5	12.5	4	2000
EF^095250LR*	9.5	47.5	25	2	1000
EF^095500LR*	9.5	47.5	50	1	500
EF^127125LR*	12.7	64	12.5	4	2000
EF^127250LR*	12.7	64	25	2	1000
EF^127500LR*	12.7	64	50	1	500
EF^190125LR*	19.0	95	12.5	4	2000
EF^190250LR*	19.0	95	25	2	1000
EF^190500LR*	19.0	95	50	1	500
EF^254250LR*	25.4	127	25	2	600
EF^254500LR*	25.4	127	50	1	300
EF^381500LR*	38.1	190	50	1	100

^ = S (single sided), D (double sided); * = Colour (4=Yellow, 9=White)
Recommended ribbon: 2020 series

+ RELATED PRODUCTS



MK10
PAGE 106



MK10-DH
PAGE 108



EOS1
PAGE 104



RIBBONS
PAGE 81



+ INFORMATION

ET - Extreme Temperature Printable Heat Shrink Sleeves

Very flexible, high temperature rated, highly flame retardant, heat shrinkable tubing (2:1 shrink ratio). Flexible polyvinylidene fluoride sleeves used for wire identification. Suitable for use in applications where extreme temperatures and harsh chemicals can be found.

- + Flame Retardant to UL224 VW-1
- + Self Extinguishing
- + Meets requirements of SAE-DTL-23053/18
- + Easy Pick Application
- + Backing card perforated after every sleeve
- + Print performance to Military Specifications
- + RoHS and REACH Compliant

+ SPECIFICATIONS

Temperature range
-55°C to +225°C

Material
flexible polyvinylidene fluoride

Print
thermal transfer

Standard colours
white

Shrink ratio
2:1

Certified and issued to:
SAE-AMS-DTL-23053/18
UL224 VW-1 Flammability

Print performance to military specifications
Adherence: SAE-AS5942
Fluid Resistance: MIL202G Method 215J

+ PROPERTIES

PROPERTY	VALUE
Continuous Operating Temperature	-55°C to +225°C
Heat Ageing (225°C x 168h)	Pass no cracking
Heat Shock (275°C x 4h)	No cracking, flowing or dripping
Min. Shrink Temp for full Recovery	+150°C (starts at 110°C)
Longitudinal Change	+0%, -10% Max.
Tensile Strength	24.0 MPa Min.
Elongation at Break	200% Min.
Water Absorption	0.10% Max.
Flammability	UL 224 VW1
Dielectric Strength	20kV/mm Min.

+ RELATED PRODUCTS



MK10
PAGE 106



MK10-DH
PAGE 108



EOS1
PAGE 104

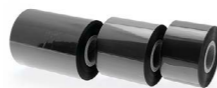

RIBBONS
PAGE 81

PROSLEEVE - ET
EXTREME TEMPERATURE PERFORMANCE

+ PRODUCT RANGE

TYPE	DIAMETER (mm) BEFORE SHRINKING	DIAMETER (mm) AFTER SHRINKING	SLEEVE LENGTH (mm)	MARKERS ACROSS	MARKERS / BOX
ET [^] 024125LR9	2.4	12	12.5	4	4000
ET [^] 024250LR9	2.4	12	25	2	2000
ET [^] 024500LR9	2.4	12	50	1	1000
ET [^] 032125LR9	3.2	16	12.5	4	4000
ET [^] 032250LR9	3.2	16	25	2	2000
ET [^] 032500LR9	3.2	16	50	1	1000
ET [^] 048125LR9	4.8	24	12.5	4	4000
ET [^] 048250LR9	4.8	24	25	2	2000
ET [^] 048500LR9	4.8	24	50	1	1000
ET [^] 064125LR9	6.4	32	12.5	4	4000
ET [^] 064250LR9	6.4	32	25	2	2000
ET [^] 064500LR9	6.4	32	50	1	1000
ET [^] 095125LR9	9.5	47.5	12.5	4	2000
ET [^] 095250LR9	9.5	47.5	25	2	4000
ET [^] 095500LR9	9.5	47.5	50	1	500
ET [^] 127125LR9	12.7	64	12.5	4	2000
ET [^] 127250LR9	12.7	64	25	2	4000
ET [^] 127500LR9	12.7	64	50	1	500
ET [^] 190125LR9	19.0	95	12.5	4	2000
ET [^] 190250LR9	19.0	95	25	2	4000
ET [^] 190500LR9	19.0	95	50	1	500
ET [^] 254250LR9	25.4	127	25	2	600
ET [^] 254500LR9	25.4	127	50	1	300
ET [^] 381500LR9	38.1	190	50	1	100

[^] = S (single sided), D (double sided);
Recommended ribbon: HT series



+ INFORMATION

- + PA type sleeve with oval, transparent pocket for PFC and PP+ profile
- + Specially designed pocket protects the label from damage and keeps it in place
- + PFC or PP+ may be inserted both before or after application of the marker
- + Four sizes with the same pocket size cover most cable diameters
- + Help to reduce inventory and reduce cost of marking
- + Also available in Halogen free material (PTZ+).

+ PROPERTIES

Temperature range
PT+: -30°C to +60°C
PTZ+: -30°C to +90°C

Material
PT+: PVC
PTZ+: ZEREX

+ RELATED PRODUCTS

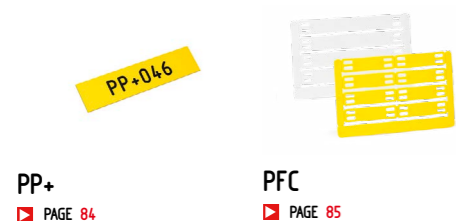

+ APPLICATION

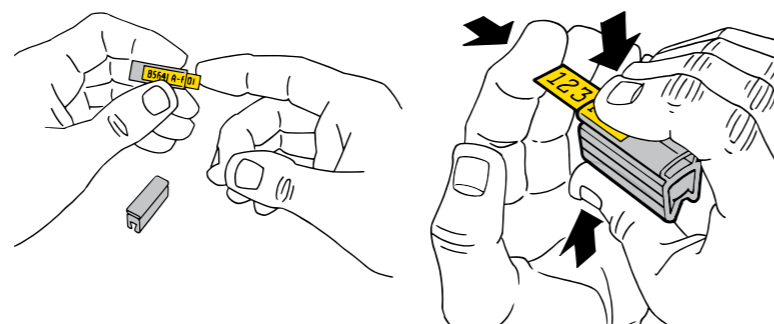

+ DIMENSIONS

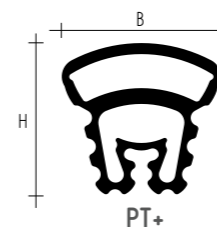

TYPE	LENGTH (mm)	WIDTH (B mm)	HEIGHT (H mm)
PT+02	12/15/18/21/30	5.0	5.0
PT+10	12/15/18/21/30	5.0	7.0
PT+20	12/15/18/21/30	6.0	10.0
PT+30	12/15/18/21/30	10.0	19.0

+ SIZES AND PACKAGING

TYPE	DIAMETER / AREA*	LENGTH	SUITABLE TAG	PACKAGING
PT+02/PTZ+02	~13 - 3.0 mm 0.5 to 0.75 mm ²	12 mm 15 mm 18 mm 21 mm 30 mm	PFC042 / PP+046	pack of 200 pcs
PT+10/PTZ+10	~25 - 5.0 mm 0.75 to 4.0 mm ²	12 mm 15 mm 18 mm 21 mm 30 mm	PFC042 / PP+046	pack of 200 pcs
PT+20/ PTZ+20	~4.0 - 10.0 mm 2.5 to 10.0 mm ²	12 mm 15 mm 18 mm 21 mm 30 mm	PFC042 / PP+046	pack of 100 pcs
PT+30/ PTZ+30	~8.0 - 16.0 mm 16.0 to 50.0 mm ²	12 mm 15 mm 18 mm 21 mm 30 mm	PFC042 / PP+046	pack of 50 pcs

* Size shown refers to BS6231 tri-rated cable.



+ INFORMATION

- + Open marker sleeve with label pocket for snap on mounting on cables and wires
- + Flexible mounting of holder sleeve before or after connection of wire or cable
- + Fast insertion of marker tag by light pressure on top of pocket
- + The marker sleeve is secured by stiff barbs but is still readjustable.

+ PROPERTIES

Temperature range
-30°C to +60°C

Material
PVC non-flammable, self-extinguishing according to UL94-V0

+ RELATED PRODUCTS

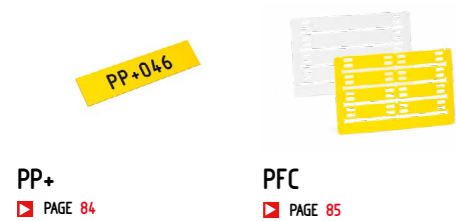

PP+
PAGE 84

PFC
PAGE 85

+ APPLICATION

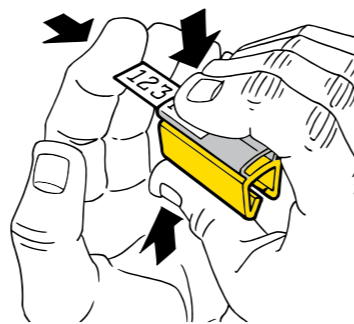

+ DIMENSIONS

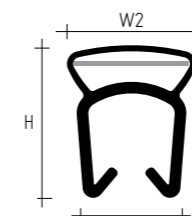

TYPE	HEIGHT (H mm)	WIDTH (W mm)	WIDTH (W2 mm)
PTC-10	5.4	3.7	4.6
PTC-20	6.5	4.5	4.6
PTC-30	7.8	5.7	4.6
PTC-40	9.3	6.9	4.6
PTC-50	10.8	8.2	4.6

+ SIZES AND PACKAGING

TYPE	DIAMETER / AREA	LENGTH	SUITABLE TAG	PACKAGING
PTC10	-2.4 - 3.0 mm -0.5 - 1.5 mm ²	15 mm 21 mm 30 mm	PFC042 or PP+046	pack of 200 pcs
PTC20	-3.0 - 4.0 mm -1.5 - 2.5 mm ²	15 mm 21 mm 30 mm	PFC042 or PP+046	pack of 200 pcs
PTC30	-4.0 - 5.0 mm -2.5 - 4.0 mm ²	15 mm 21 mm 30 mm	PFC042 or PP+046	pack of 200 pcs
PTC40	-5.0 - 6.2 mm -4.0 - 6.0 mm ²	15 mm 21 mm 30 mm	PFC042 or PP+046	pack of 100 pcs
PTC50	-6.0 - 7.2 mm -6.0 - 10.0 mm ²	15 mm 21 mm 30 mm	PFC042 or PP+046	pack of 100 pcs

* Size shown refers to BS6231 tri-rated cable

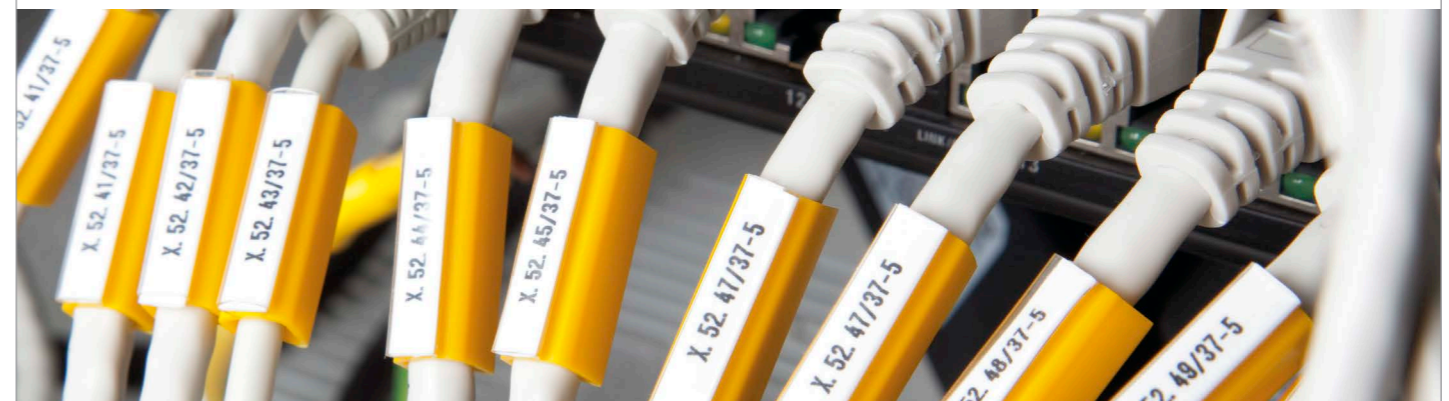



+ INFORMATION

- + Transparent holder for marking cables with labels PFC-card or PP+ profile
- + Four lengths, three widths and endless profiles cover most cable marking demands
- + Can be installed on cables with very large diameters (depending on the length of the cable tie).
- + The label is easily inserted into the holder, which ensures quick installation.
- + Holder protects the label from damage

+ PROPERTIES

Temperature range
-30°C to +60°C

Material
PVC



+ DIMENSIONS AND PACKAGING

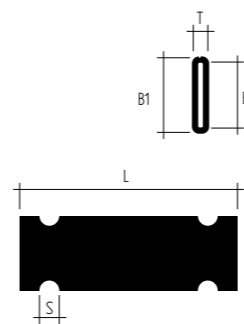

TYPE	LENGTH (L mm)	WIDTH (B1 mm)	WIDTH HOLE (S mm)	PACKAGING
PM 10/33	33	6.0	3.0	100 pcs
PM 20/33	33	11.3	3.0	100 pcs
PM 20/66	66	11.3	3.0	50 pcs
PM 24/66	66	13.9	3.9	50 pcs

+ APPLICATION

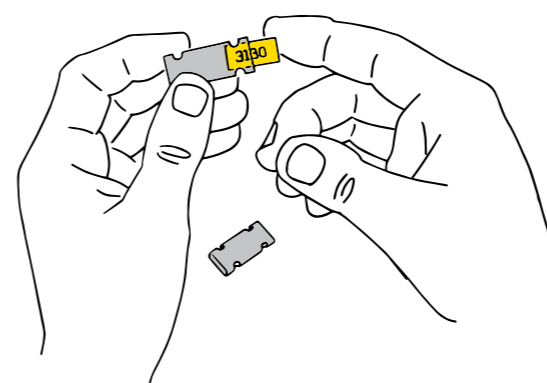

+ MARKER TAGS

TYPE	MARKER TAG
PM 10/33	PP+046 / PFC042
PM 20/33	PFC9518 / PFC7533 / PP+090
PM 20/66	PFC7533 / PP+090
PM 24/66	PROMARK-PL120, PP+090, 2 x PFC09518

+ RELATED PRODUCTS



PP+
PAGE 84

PFC
PAGE 85

HFC
PAGE 95



+ INFORMATION

- + Transparent sleeve for cable marking
- + Used for PFC and PP+ profile
- + The marker tag is easily inserted to the holder, which ensures quick installation and protection from harmful external factors.
- + Fitting and fastening with cable ties.

+ PROPERTIES

Temperature range
-30°C to +60°C

Material
PVC



+ DIMENSIONS AND PACKAGING

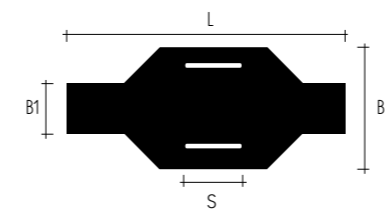

TYPE	LENGTH (L mm)	WIDTH (B1 mm)	WIDTH HOLE (S mm)	PACKAGING
PTM 10/23	23	6.0	5.0	500 pcs
PTM 10/30	30	6.0	5.0	500 pcs
PTM 20/20	20	11.0	5.0	500 pcs

+ APPLICATION

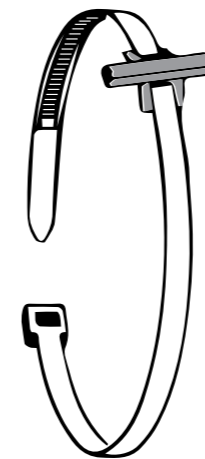

+ MARKER TAGS

TYPE	MARKER TAG
PTM 10/23	PP+046, PFC04221
PTM 10/30	PP+046, PFC04230
PTM 20/20	PP+090, PFC09518

+ RELATED PRODUCTS



PP+
PAGE 84

PFC
PAGE 85

HFC
PAGE 95



+ INFORMATION

- + Flat cable marker with pre-punched holes
- + Easy to mount on the cable with cable ties
- + Very durable and fast print with printer MK10 or MK10-DH, up to 2000 markers per hour.
- + Also available pre-printed according to customer specifications.
- + Flexible material which neatly forms to the cable
- + Adjustable font size gives the ability to have up to 5 lines of text

+ SPECIFICATIONS

- + PPQ + is a flat profile with pre-punched holes. The profile is supplied on reels and have fixed lengths. PPQ+ can be printed on the MK-10 or EOS1 printers, or can be ordered pre-printed according to customer specifications.
- + Profile to be printed on the MK10 or EOS1 printers is supplied on 20 meter reels containing between 300 and 500 markers.

+ PROPERTIES

Temperature range
 Temperature range: -20°C to +60°C (-4°F to +140°F)
 Storage temperature: +10°C to +27°C (+32°F to 81°F) < 95% Rh

Material
 Soft PVC

Print
 thermal transfer

Resistance
 self-extinguishing to UL94-V0
 excellent service life and resistance to UV radiation and chemicals.

Standard colours
 yellow and white

+ RELATED PRODUCTS



MK10
 PAGE 106

EOS1
 PAGE 104

HFC
 PAGE 95

RIBBONS
 PAGE 81

+ DIMENSIONS AND PACKAGING

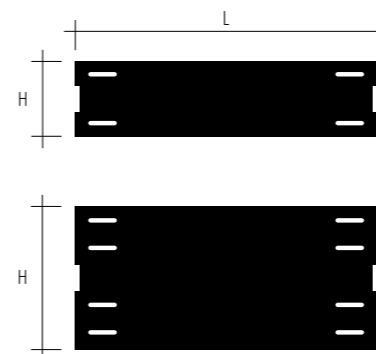

TYPE	HEIGHT (H mm)	LENGTH (L mm)	PACKAGING
PPQ+10040DN*	10 mm	40 mm	20 m
PPQ+10060DN*	10 mm	60 mm	20 m
PPQ+10080DN*	10 mm	80 mm	20 m
PPQ+19040DN*	19 mm	40 mm	20 m
PPQ+19060DN*	19 mm	60 mm	20 m
PPQ+19080DN*	19 mm	80 mm	20 m
PPQ+38060DN*	38 mm	60 mm	20 m
PPQ+38080DN*	38 mm	80 mm	20 m
PPQ+38100DN*	38 mm	100 mm	20 m

* - product is available in two colors: yellow (4) white (9)

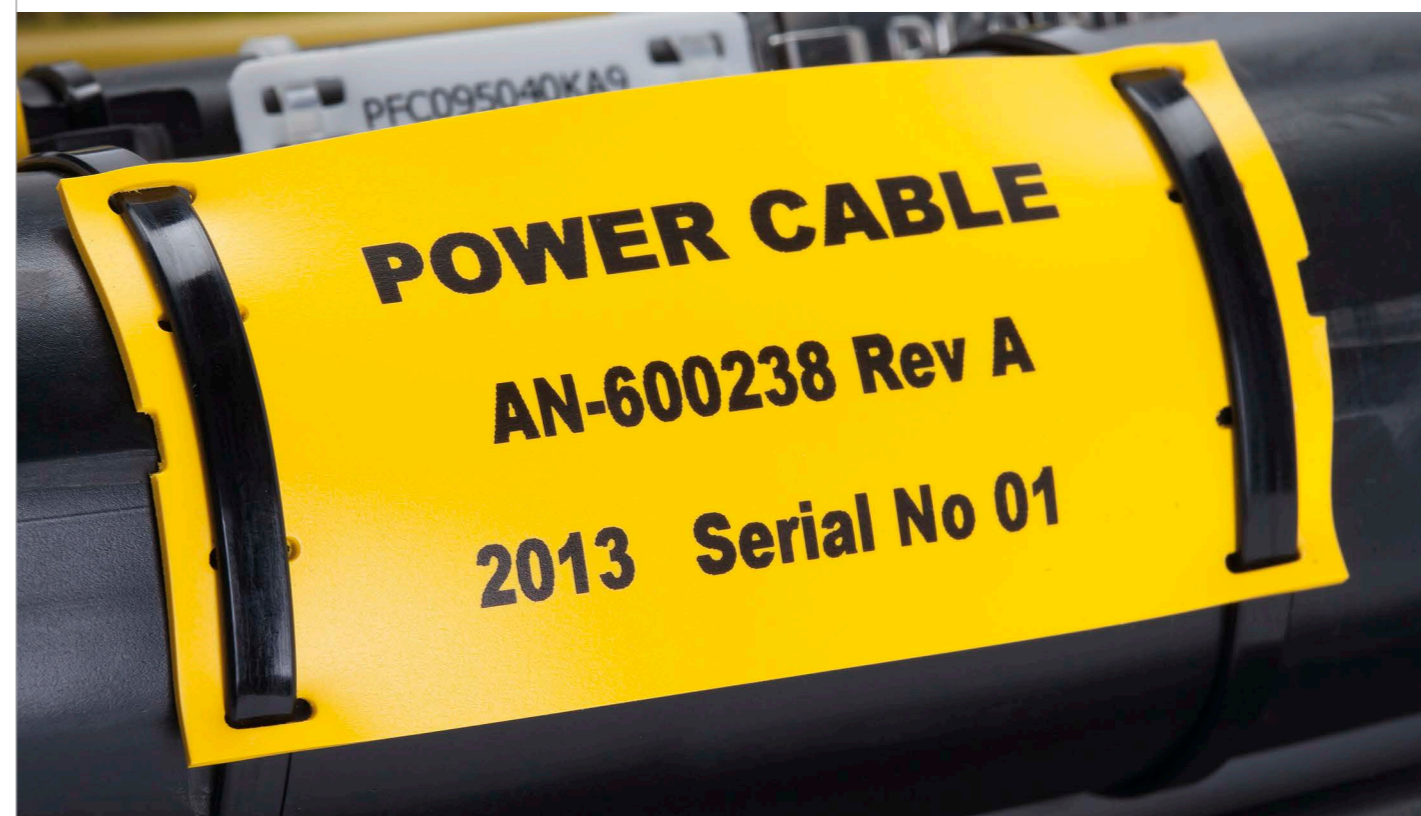



+ INFORMATION

CMZ - Zero Halogen and Flame Retardant

The CMZ cable marker is extremely strong with high tear strength properties. They are zero halogen and UL94 V-0 rated. They will not break down in reaction to water, and are resistant to bacterial attacks. They are UV stable and suitable for use in harsh chemical environments.

- + Zero halogen
- + UV stable print quality
- + High tear strength
- + Print performance to military requirements
- + Flame retardant
- + High degree of mark permanence
- + RoHS and REACH Compliant Thermal printed

+ SPECIFICATIONS

Temperature range

Operating Temperature -25°C to +80°C

Material

Thermoplastic polyether polyurethane

Print performance

Mark permanence: MIL-M 81531 AS
 Fluid resistance: MIL-STD-202G test method 215 2002
 Enhanced fluid test beyond MIL-202G

Standard colours

yellow, white and red

Resistance:

Raw material is rated V-0 according to UL94

+ DIMENSIONS | PACKAGING

TYPE	MARKER SIZE	TEXT AREA	PACK QUANTITY
CMZ060010LR*	60x10 mm	40x10 mm	1450 pcs
CMZ075015LR*	75x15 mm	55x15 mm	1100 pcs
CMZ090025LR*	90x25mm	70x25 mm	750 pcs

* = Colour (2=Red, 4=Yellow, 9=White) Recommended ribbon: 510 series

+ RELATED PRODUCTS



MK10
PAGE 106

EOS1
PAGE 104

HFC
PAGE 95

RIBBONS
PAGE 81



+ INFORMATION

CMM - Military Grade

The CMM cable maker is made from flame retardant polyolefin material. They have excellent UV, chemical and mechanical resistance and provide print adhesion to MIL. Spec standards.

- + UV stable print quality
- + Print Quality to Mil. Spec Standards Thermal printed
- + Flame retardant
- + RoHS and REACH Compliant

+ SPECIFICATIONS

Temperature range

Operating Temperature -55°C to +135°C

Material

Polyolefin Sheet

Print performance

Adherence: SAE-AS5942
 Fluid resistance: MIL202 Method 215K

Standard colours

yellow, white

Resistance:

Flame retardant to: NF F00-608 type H & NF C32-070

Certified and Issued to:

SAE-AMS-DTL-23053/6 class 1

+ DIMENSIONS | PACKAGING

TYPE	MARKER SIZE	TEXT AREA	PACK QUANTITY
CMM060010LR*	60x10 mm	40x10 mm	1450 pcs
CMM075015LR*	75x15 mm	55x15 mm	1100 pcs
CMM090025LR*	90x25mm	70x25 mm	750 pcs

* = Colour (4=Yellow, 9=White) Recommended ribbon: 2020 series

+ RELATED PRODUCTS



MK10
PAGE 106

EOS1
PAGE 104

HFC
PAGE 95

RIBBONS
PAGE 81



+ INFORMATION

CMD - Diesel Specification

The CMD cable marker is a flame retardant marker designed to survive exposure to diesel, organic fluids and oils for long periods at high temperatures, and are ideal for mass transit applications: they are UV stable and provide print adhesion to MIL Spec standards

- + UV stable print quality
- + Diesel Resistant
- + Print Quality to Mil. Spec Standards Thermal printed
- + Flame retardant
- + Meets UL 125C, 300V
- + RoHS and REACH Compliant

+ SPECIFICATIONS

Temperature range

Operating Temperature -55°C to +135°C

Material

Polyolefin

Print performance

Adherence: SAE-AS5942

Fluid resistance: MIL202 Method 215K

Standard colours

yellow, white

Resistance:

Flame retardant

Certified and Issued to:

SAE-AMS-DTL-23053/6 class 1

SNCF Spec. NF-F00-608 type H

+ DIMENSIONS | PACKAGING

TYPE	MARKER SIZE	TEXT AREA	PACK QUANTITY
CMD060010LR*	60x10 mm	40x10 mm	1450 pcs
CMD075015LR*	75x15 mm	55x15 mm	1100 pcs
CMD090025LR*	90x25mm	70x25 mm	750 pcs

* = Colour (4=Yellow, 9=White)

Recommended ribbon: 2020 series

+ RELATED PRODUCTS



MK10
PAGE 106

EOS1
PAGE 104

HFC
PAGE 95

RIBBONS
PAGE 81



+ INFORMATION

CML - Extended Fire Specification

The CML cable marker is made from zero halogen, low toxicity, radiation cross-linked UV stabilised polyolefin. This material has been approved for LUL for use on mass transit applications. It features extended fire safety and low smoke properties.

- + Zero halogen
- + UV stable print quality
- + London Underground Approval
- + Print Quality to Mil. Spec Standards
- + Thermal printed
- + Flame retardant
- + Low Smoke
- + Self Extinguishing
- + RoHS and REACH Compliant

+ SPECIFICATIONS

Temperature range

Operating Temperature -40°C to +105°C (175°C short periods)

Material

Cross-linked UV Stabilised Polyolefin

Print performance

Adherence: NF F 16-101

Fluid resistance: NF F 16-1-1

Standard colours

yellow, white

Resistance:

Self Extinguishing to UL94-V0

Certified and Issued to:

BS 4G198, Part 3, Type 15

Def Stan 59-97, Type 8

LUL 1-085

BS6853 Cat. 1a

LUL 2-01001-002 (E104-2A6)

+ DIMENSIONS | PACKAGING

TYPE	MARKER SIZE	TEXT AREA	PACK QUANTITY
CML60010LR*	60x10 mm	40x10 mm	1450 pcs
CML75015LR*	75x15 mm	55x15 mm	1100 pcs
CML90025LR*	90x25mm	70x25 mm	750 pcs

* = Colour (4=Yellow, 9=White)

Recommended ribbon: 2020 series

+ RELATED PRODUCTS



MK10
PAGE 106

EOS1
PAGE 104

HFC
PAGE 95

RIBBONS
PAGE 81

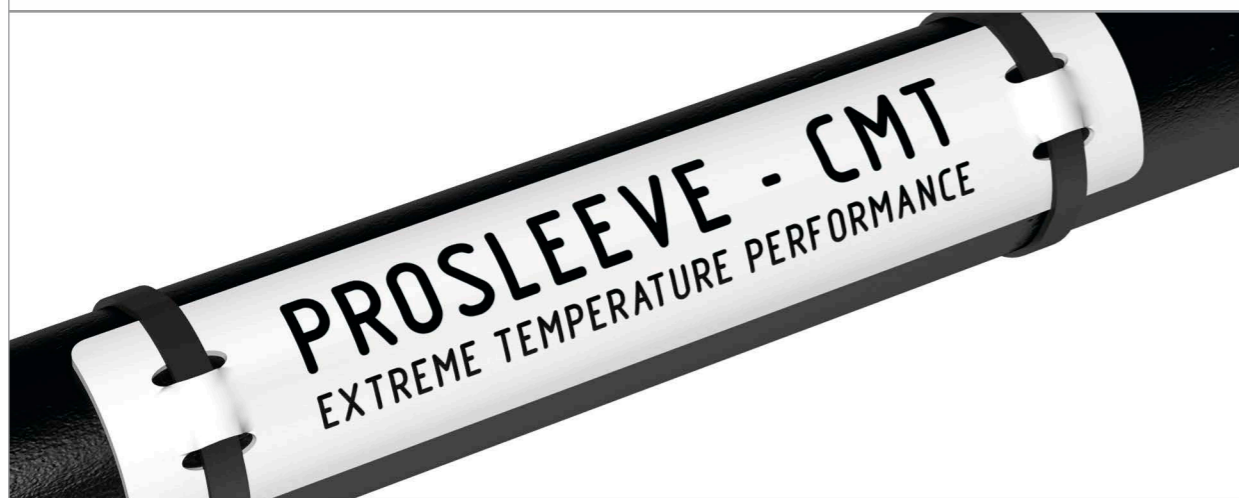

+ INFORMATION

CMT - Extreme Temperature

The CMT cable marker is made from highly flame retardant, self extinguishing material, and has excellent chemical and mechanical properties, and is UV stable.

- + UV stable print quality
- + Print Quality to Mil. Spec Standards
- + RoHS and REACH Compliant
- + Flame retardant
- + Self Extinguishing
- + Thermal printed

+ SPECIFICATIONS

Temperature range

Operating Temperature -55°C to +225°C

Material

Polyvinylidene fluoride

Print performance

Adherence: SAE-AS5942

Fluid resistance: MIL202 Method 215K

Standard colours

white

Resistance:

Flame retardant to: UL224 VW-1

Certified and Issued to:

SAE-AMS-DTL-23053/18

+ DIMENSIONS | PACKAGING

TYPE	MARKER SIZE	TEXT AREA	PACK QUANTITY
CMT060010LR9	60x10 mm	40x10 mm	1450 pcs
CMT075015LR9	75x15 mm	55x15 mm	1100 pcs
CMT090025LR9	90x25mm	70x25 mm	750 pcs

Recommended ribbon: HT series

+ RELATED PRODUCTS



MK10
PAGE 106



EOS1
PAGE 104



HFC
PAGE 95



RIBBONS
PAGE 81





+ INFORMATION

- + Complete marking system for cables, pipes and components
- + Single-character and multi-character markers which can be combined on site
- + Enhanced durability and top quality for use in extreme conditions
- + Easy to install with steel cable ties

+ PROPERTIES

Temperature range
Extreme conditions

Print
embossed

Material
Stainless steel equivalent to AISI 316



+ DIMENSIONS AND PACKAGING

TYPE	DESCRIPTION	NUMBER OF CHARACTERS	LENGTH (Lmm)	HEIGHT (H mm)	SLOT WIDTH (SW mm)	QUANTITY IN PACK
PKS10006PP	single character: A-Z, and 0-9, +, -, /, : ~ ↓	-	55	10.9	4.8	50 pcs
PKS10040*	47 mm carrier strip	6	47.0	10.3	4.8	50 pcs
PKS10060*	65 mm carrier strip	9	65.0	10.3	4.8	50 pcs
PKS10080*	87 mm carrier strip	13	87.0	10.3	4.8	50 pcs
PKS10100*	107 mm carrier strip	17	109.0	10.3	4.8	50 pcs
PKS10120*	128 mm carrier strip	20	128.0	10.3	4.8	50 pcs

* S = slot, H = hole (e.g. PKS10040S or PKS10040H)



+ RELATED PRODUCTS



SST
PAGE 98



SSTC
PAGE 99

+ APPLICATION

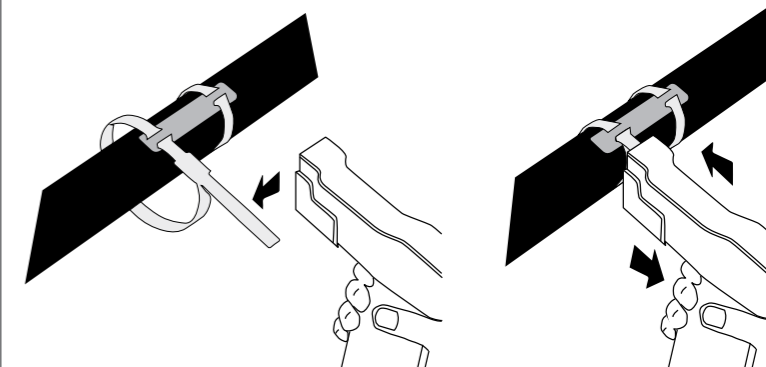



+ INFORMATION

- + Brushed stainless steel equivalent to AISI 316
- + Works in extreme conditions
- + Resistant to fire, water, moisture and corrosion
- + Brushed surface reduces light reflection (torch effect)
- + Mounted with cable ties, screws or rivets

+ PROPERTIES

Temperature range
extreme conditions

Material
AISI 316 stainless steel

Print
embossed

Packaging
sorted on adhesive tape



+ DIMENSIONS

TYPE	HEIGHT (mm)	LENGTH (L mm)	SLOT WIDTH (SW mm)	NUMBER OF FITTINGS	TEXT HEIGHT	MAX NO OF LINES *
PKS10	10	50, 70, 90, 110, 130	4,8	single 2 x 1	3,2 / 5,5	2
PKS19	19	50, 70, 90, 110, 130	4,8	single 2 x 1	3,2 / 5,5	3
PKS25	25,4	50, 70, 90, 110, 130	4,8	single 2 x 1	3,2 / 5,5	4
PKS32	32	50, 70, 90, 110, 130	4,8	double 2 x 2	3,2 / 5,5	4
PKS38	38	50, 70, 90, 110, 130	4,8	double 2 x 2	3,2 / 5,5	4

* depending on the size of the font

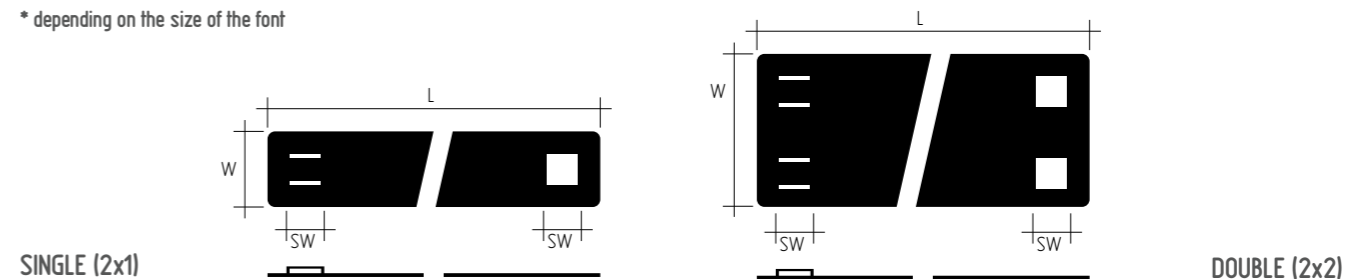

+ MAXIMUM NUMBER OF CHARACTERS PER LINE

LENGTH	TEXT HEIGHT (5,5 mm)	TEXT HEIGHT (3,2 mm)
50	8	11
70	13	18
90	18	26
110	23	33
130	28	41



+ RELATED PRODUCTS



SST
PAGE 98

SSTC
PAGE 99

+ APPLICATION

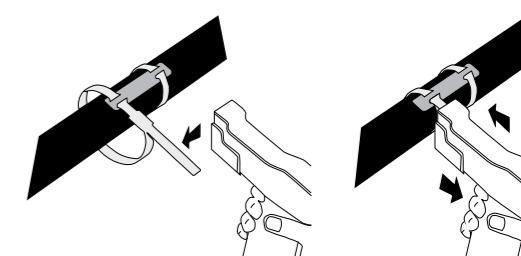

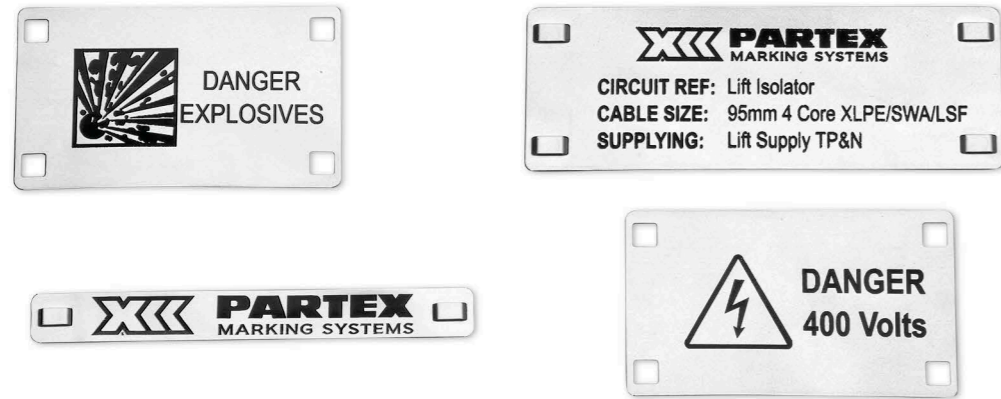

+ INFORMATION

- + Brushed stainless steel equivalent to AISI 316
- + Works in extreme conditions
- + Resistant to fire, water, moisture and corrosion
- + Brushed surface reduces light reflection (torch effect)
- + Mounted with cable ties, screws or rivets
- + Bar codes, symbols and logos can be engraved

+ PROPERTIES

Temperature range
extreme conditions

Material
AISI 316 stainless steel

Print
laser engraved

Packaging
sorted into bags



+ DIMENSIONS

TYPE	HEIGHT [mm]	LENGTH [L mm]	SLOT WIDTH [SW mm]	NUMBER OF FITTINGS*
PKS10	10	50, 70, 90, 110, 130	4,8	single 2 x 1
PKS19	19	50, 70, 90, 110, 130	4,8	single 2 x 1
PKS25	25,4	50, 70, 90, 110, 130	4,8	single 2 x 1
PKS32	32	50, 70, 90, 110, 130	4,8	double 2 x 2
PKS38	38	50, 70, 90, 110, 130	4,8	double 2 x 2

* deep slots for nylon ties, or square holes for screws/rivets. Please specify when ordering.

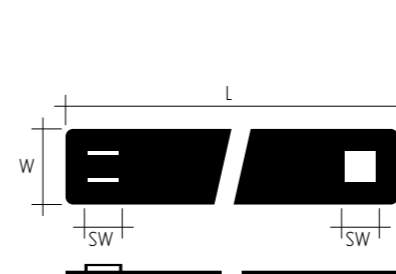

SINGLE (2x1)

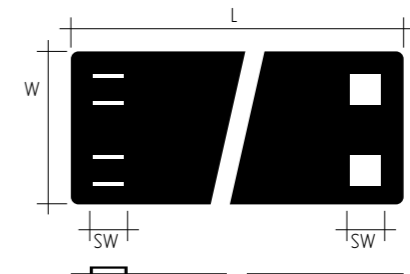

DOUBLE (2x2)

+ RELATED PRODUCTS



SST
▶ PAGE 98



SSTC
▶ PAGE 99

+ APPLICATION

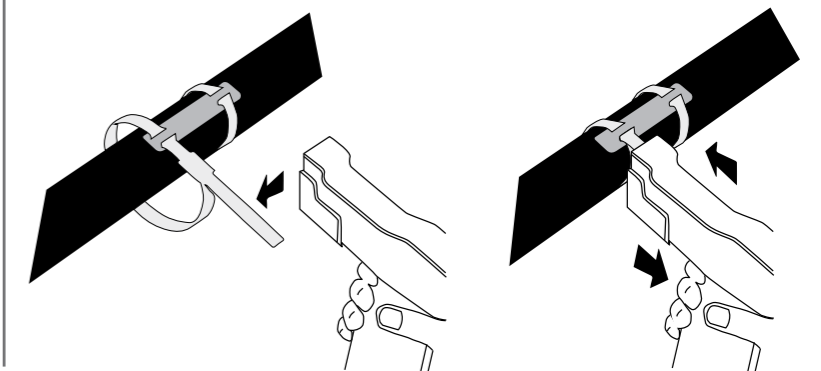







+ INFORMATION

- + A simple and cost effective way of identifying cables
- + Available in a range of colours and sizes
- + Can be secured with any Partex cable tie up to 4.8mm width.

+ DIMENSIONS

TYPE	OVERALL LENGTH	WRITABLE LENGTH	WIDTH	PACKAGING
TIETAG60*	60 mm	27 mm	9.5 mm	 pack of 100 pcs
TIETAG82*	82 mm	50 mm	9.5 mm	 pack of 100 pcs
TIETAG110*	110 mm	75 mm	9.5 mm	 pack of 100 pcs
TIETAG152*	152 mm	117 mm	9.5 mm	 pack of 100 pcs

* Available in white or yellow, specify colour when ordering

+ APPLICATION

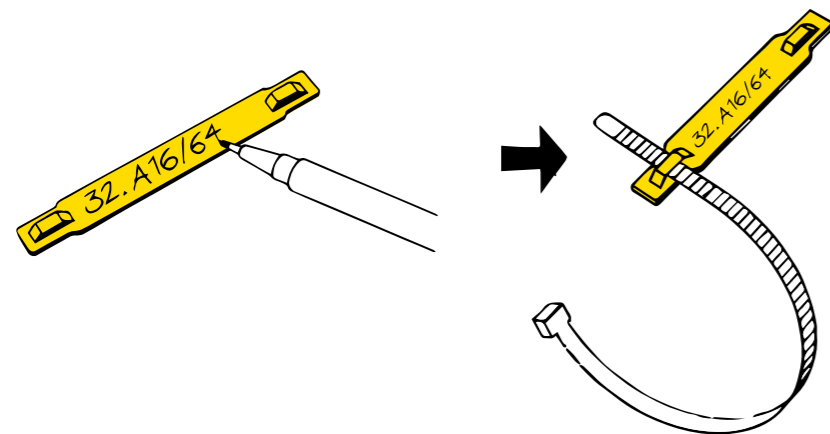

+ INFORMATION

- + Marker pen with fine tip
- + Perfect for writing on clean flat surfaces
- + The ink reacts with the material to make the text waterproof and resistant to abrasion.

+ PROPERTIES AND DIMENSIONS

TYPE	LENGTH (mm)	THICKNESS TIP	COLOR
TIE PEN	140	fine	black





+ INFORMATION

- + High quality laser engraved plates
- + Produced from your drawings or online
- + Available either plain or with self-adhesive backing
- + Choose between different hole types
- + Material thickness either 0.8, 1.6 or 3.0 mm
- + Maximum label size 600x600 mm
- + Full colour printing onto the engraved plates is also available.

+ PROPERTIES

Temperature range
-40°C to +70°C

Material
acrylic laminate

Engraving
CO² laser

Colors (plate / text)

123	black / white
123	white / black or red
123	red / white
123	blue / white
123	yellow / black
123	green / white



+ PE-P 1.6 mm

OUR STANDARD SEMI-RIGID MATERIAL WHICH IS IDEAL FOR MOST APPLICATIONS.

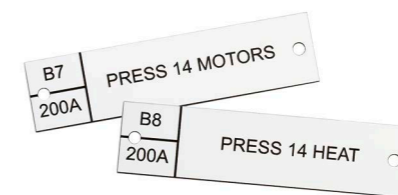

+ PE-P 0.8 mm

A FLEXIBLE MATERIAL WHICH IS SUITABLE FOR PRODUCING SMALL LEGEND PLATES



SSR1	PS1	R1	SSR1	PS1	R1
SSR1	PS1	R1	SSR1	PS1	R1
SSR1	PS1	R1	SSR1	PS1	R1
SSR1	PS1	R1	SSR1	PS1	R1
SSR1	PS1	R1	SSR1	PS1	R1
SSR1	PS1	R1	SSR1	PS1	R1

+ PE-P 3.0 mm

A THICKER MATERIAL WHICH IS IDEAL FOR APPLICATIONS WHERE STRENGTH AND RIGIDITY ARE REQUIRED

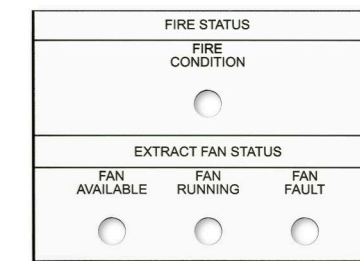
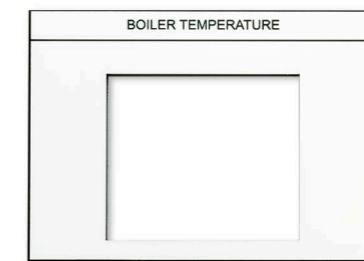

+ SSDT - DOG TAGS

ENGRAVED STAINLESS STEEL DISCS AND CHAINS, IDEAL FOR INDUSTRIAL APPLICATIONS

TYPE	DESCRIPTION	PACKAGING
SSDT-25	316 Stainless steel dog tag with M4 hole; 25mm Diameter; 0.8mm thick	1 pcs
SSDT-50	316 Stainless steel dog tag with M4 hole; 50mm Diameter; 0.8mm thick	1 pcs
Q43	316 Stainless steel No3 bead chain and connector; 150mm long	1 pcs





+ INTRODUCTION

- + To complement our hugely successful Laser Engraving Service, Partex are able to offer high quality printed polypropylene labels at extremely competitive prices, produced in house at our Coleshill manufacturing facility.
- + In addition to the standard labels shown in the following pages, we are also able to produce bespoke labels to your design. We offer a very quick turnaround for both short and long runs of labels. There are no set-up charges.
- + We can offer either;
 - Our SL range of thermally printed labels with black text or symbols on a high visibility yellow background, this durable range of labels is ideal for warning and danger labels.
 - Our CL range of glossy white labels are printed using a state of the art Memjet printer which can reproduce full colour photo quality labels in a wide variety of sizes.
- + Both types of label are made from strong polypropylene material which will not tear or stretch out of shape when applied. They are backed with a strong permanent adhesive which will even adhere to irregular surfaces and is resistant to water, oil and many chemicals.

+ INFORMATION

- + A wide range of durable thermal or colour printed labels.
- + Easy to apply non-tear material.
- + Resistant to water, oil and chemicals.
- + Good adhesion to irregular surfaces.
- + Colour labels produced using latest MemJet technology.
- + In addition to our standard catalogue range we are able to produce special labels to suit customers requirements.

+ PROPERTIES

Temperature range
-10°C to +80°C

Material
Gloss finish Polypropylene
Permanent adhesive

Reach & RoHS compliant

SL5025D110R250

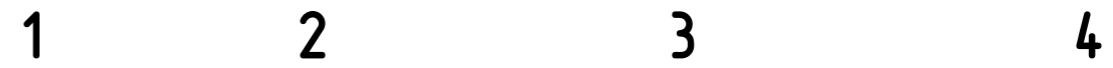

1. Product series

SL = Standard thermal Label yellow/black
CL = full Colour Label

2. Label size

eg: 5025 = 50 x 25 mm
8035 = 80 x 35mm

3. Description

eg: D110 = Danger 110 Volts
HV = High Voltage

4. Packaging

B10 (bag of 10)
R50 (roll of 50)
R250 (roll of 250)
R500 (roll of 500)

STANDARD LABELS



SL5025D110



SL5025D115



SL5025D230



SL5025D240



SL5025D380



SL5025D400



SL5025D415



SL5025D440



SL5025DLT



SL5025DIE



SL5025WIS



SL5025SEC

+ 50x50 mm



+ 80x35 mm



+ 75x50 mm

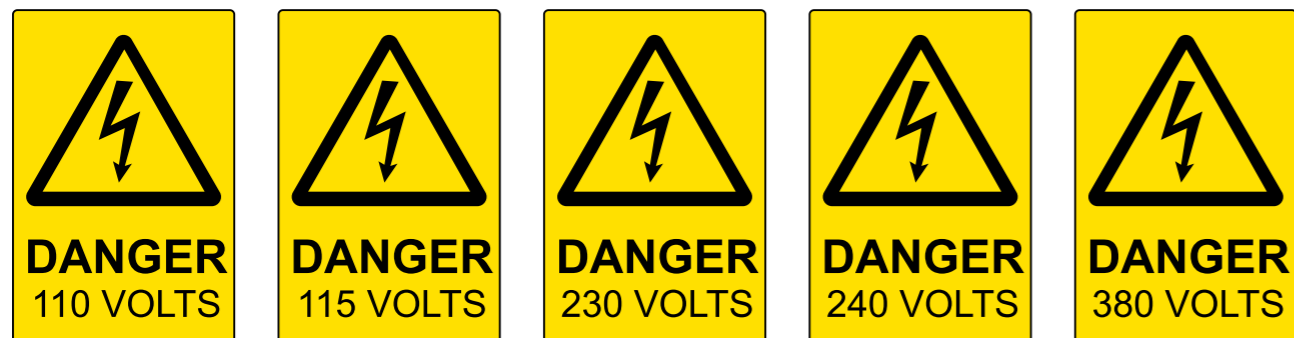

SL7550D110 SL7550D115 SL7550D230 SL7550D240 SL7550D380

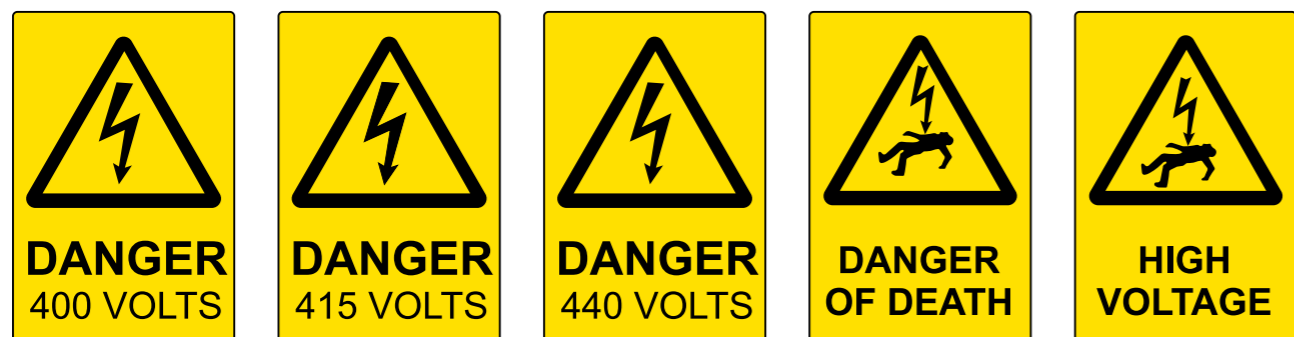

SL7550D400 SL7550D415 SL7550D440 SL7550DD SL7550HV



SL7550CHW



SL7550DMM

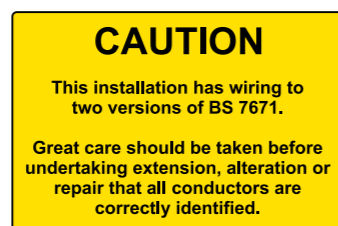

SL7550CBS



SL7550IBS



CL7550CHW



CL7550DMM

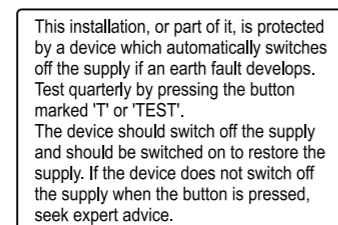

CL7550TEST

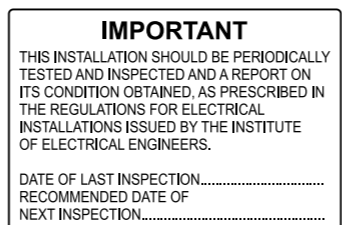

CL7550IID

+ 75x50 mm

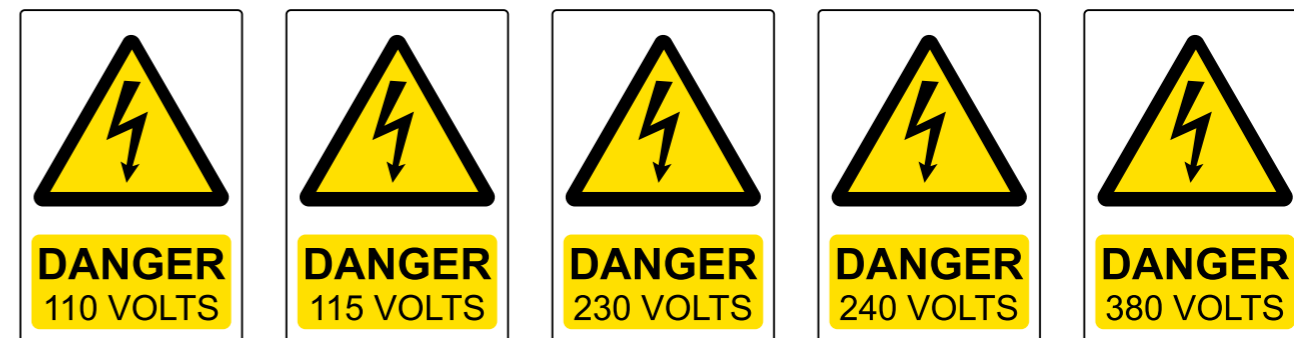

CL7550D110 CL7550D115 CL7550D230 CL7550D240 CL7550D380

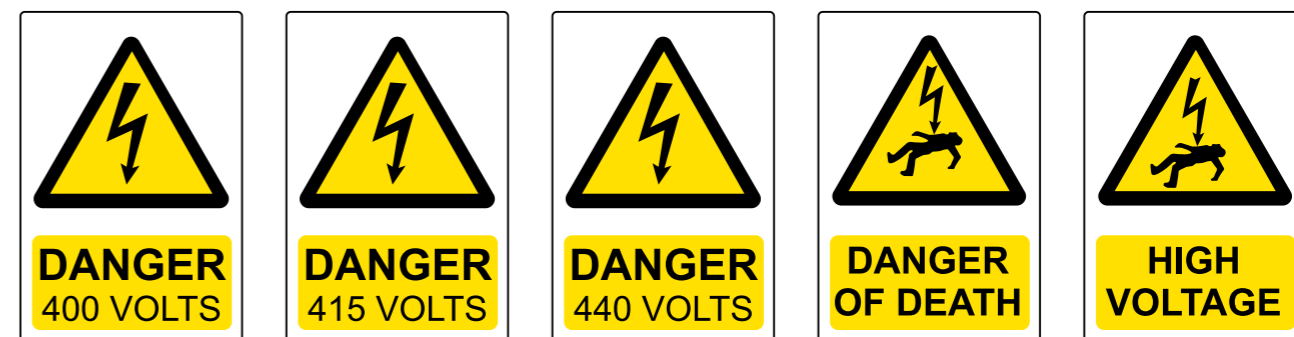

CL7550D400 CL7550D415 CL7550D440 CL7550DD CL7550HV

CUSTOMISED PAT TEST LABELS. *

+ 38x19 mm

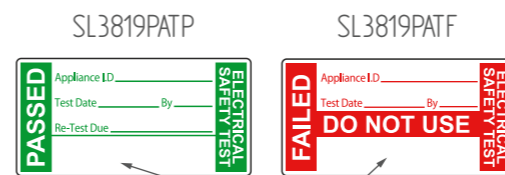

Your Details Here

+ 50x25 mm

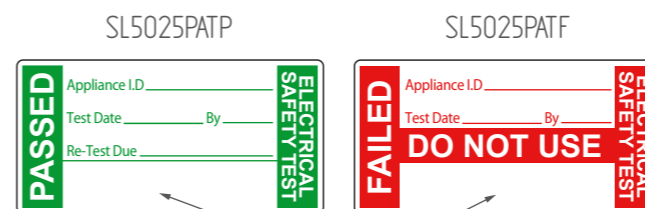

Your Details Here

+ 60 mm DIAMETER

EMERGENCY STOP DISCS.

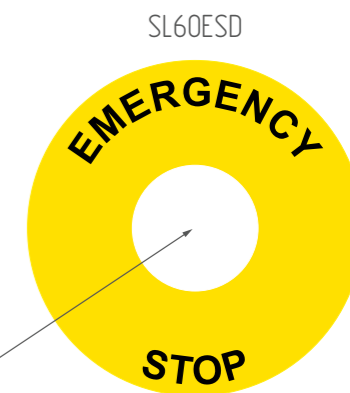

* Your details or logo can be added to these labels at no extra cost.

If you can't find the label you're looking for, please ask us. We have extensive stocks of blank labels in a wide range of sizes and can produce customised labels for immediate delivery.



+ INFORMATION

EPL - Enhanced Panel Label

EPL are a glossy, robust scratch resistant label for the identification of electrical components. They are resistant to alcohol, oils and UV. The high tack self-adhesive backing can even be affixed to uneven surfaces.

+ PROPERTIES

Temperature range

Operating Temperature -55°C to +135°C

Material

Foam backed polyester with permanent acrylic adhesive

Standard colours

yellow, white, silver

+ SPECIFICATIONS

TYPE	HEIGHT	LENGTH	PACK QUANTITY
EPL027008LR*	27 mm	8 mm	2500
EPL027125LR*	27 mm	12.5 mm	2000
EPL027015LR*	27 mm	15 mm	1500
EPL027018LR*	27 mm	18 mm	1500
EPL035019LR*	35 mm	19 mm	1250
EPL045015LR*	45 mm	15 mm	1500
EPL048019LR*	48 mm	19 mm	1250
EPL060030LR*	60 mm	30 mm	750
EPL069019LR*	69 mm	19 mm	1200
EPL069150LR*	69 mm	150 mm	200
EPL090045LR*	90 mm	45 mm	500
EPL100030LR*	100 mm	30 mm	500
EPL100050LR*	100 mm	50 mm	500
EPL100140LR*	100 mm	140 mm	500

*= Colour (4=Yellow, 8=Silver, 9=White) other colours available on request
Recommended Ribbon: 510 series

+ INFORMATION

EPF - Low Fire Hazard

EPF are a glossy, robust scratch resistant label for the identification of electrical components. They are resistant to alcohol, oils and UV. The high tack self-adhesive backing can even be affixed to uneven surfaces.

+ PROPERTIES

Temperature range

Recommended Application Temperature 18°C to 35°C
Operating Temp -40°C to 105°C (175°C short periods)

Material

Modified acrylic

Standard colours

yellow, white

+ SPECIFICATIONS

TYPE	HEIGHT	LENGTH	PACK QUANTITY
EPF045015LR*	45 mm	15 mm	250
EPF069019LR*	69 mm	19 mm	250
EPF090045LR*	90 mm	45 mm	250
EPF100050LR*	100 mm	50 mm	250

*= Colour (4=Yellow, 9=White) Recommended Ribbon: 2020 series

+ RELATED PRODUCTS



MK10
PAGE 106



EOS1
PAGE 104



+ INFORMATION

Thermal Transfer Ribbons

Partex offer a wide range of thermal transfer ribbons specifically designed to complement the ProSleeve range of products. Each ribbon has been specially formulated to provide the highest standard of print quality and adherence when used with our range of printers. It is important to select the correct ribbon to match your heat-shrink, cable markers or panel labels.

+ TYPE RIBBONS

TYPE	TYPE	PRINT COLOUR	WIDTH	LENGTH	PACK QTY
TYPE 2020	MK10-RB-BK2020-40	black	40 mm	300 Metres	1
	MK10-RB-BK2020-60	black	60 mm	300 Metres	1
	MK10-RB-BK2020-80	black	80 mm	300 Metres	1
	MK10-RB-BK2020-100	black	100 mm	300 Metres	1

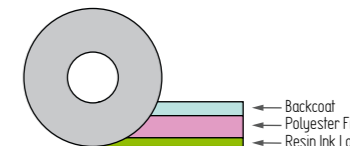

Recommended for printing onto the following ProSleeve products: MSS/MSD, HFS/HFD, EFS/EFD, NFS/NFD, SGS/SGD, CMD, CML, CMM, EPF, PO/POZ, PPQ+.

- + **Temperature:** 5°C to 35°C (41°F to 95°F)
- + Offers superior resistance to solvents, including Skydrol, Kilforost, IPA, brake fluid and aircraft fuel
- + Offers superior scratch resistance.

TYPE	TYPE	PRINT COLOUR	WIDTH	LENGTH	PACK QTY
TYPE 510	MK10-RB-BK510-40	black	40 mm	300 Metres	1
	MK10-RB-WE510-40	white	40 mm	300 Metres	1
	MK10-RB-BK510-55	black	55 mm	300 Metres	1
	MK10-RB-BK510-83	black	83 mm	300 Metres	1
	MK10-RB-BK510-110	black	110 mm	300 Metres	1
MK10-RB-WE510-110	white	110 mm	300 Metres	1	

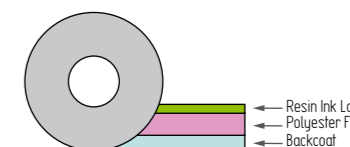

Recommended for printing onto the following ProSleeve products: HFS/HFD, CMZ, EPL, EPF, PO/POZ, PPQ+.

- + **Temperature:** 5°C to 35°C (41°F to 95°F)
- + Offers superior resistance to solvents, Kerosene, IPA, Gasoline and Water
- + Offers superior scratch resistance.

TYPE	TYPE	PRINT COLOUR	WIDTH	LENGTH	PACK QTY
FTI-M	MK10-RB-BKFTM-110	black	110 mm	300 Metres	1

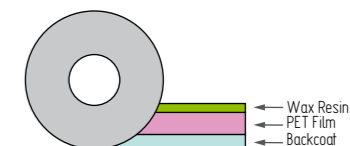

Recommended for printing onto the following ProSleeve products: MSS/MSD, EFS/EFD, CML, EPF.

- + **Temperature:** 5°C to 35°C (41°F to 95°F)
- + Offers good resistance to UV light.
- + Offers good smear resistance at temperatures up to 50°C.

TYPE	TYPE	PRINT COLOUR	WIDTH	LENGTH	PACK QTY
HT	MK10-RB-BKHT-70	black	70 mm	300 Metres	1

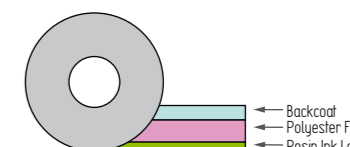

Recommended for printing onto the following ProSleeve products: ETS/ETD, CMT.

- + **Temperature:** 5°C to 225°C (41°F to 435°F)
- + Offers superior resistance to high temperatures.
- + Offers superior scratch resistance.



+ INFORMATION

- + Universal marking system for control panels and components
- + Rapid installation using pre-marked or write-on files fixed to unique rail system.
- + Rail mounted in seconds using self-adhesive backing and/or rivets and screws.
- + Large, clear legends for instant identification even at distance.

+ PROPERTIES

Temperature range
-20°C to +60°C

Material
Cadmium and silicon free rigid PVC

+ RELATED PRODUCTS

PP+090

PP+090
PAGE 84

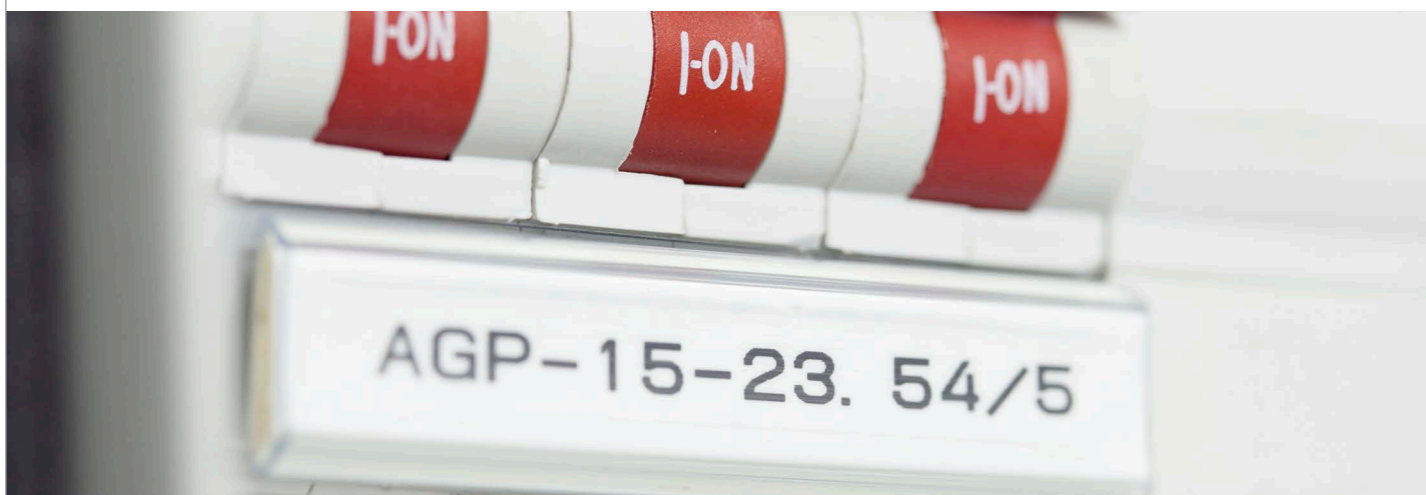

+ DIMENSIONS AND PACKAGING

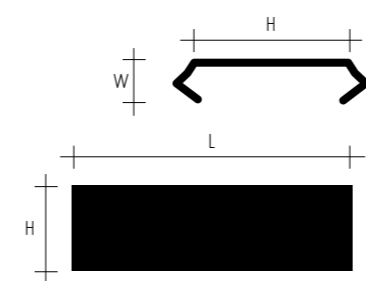

White markers with black print

TYPE	MODULE WIDTH	THICKNESS (mm)	HEIGHT (mm)	LENGTH (mm)	PACKAGING
PS-20006	1/3	4.2	12.9	55	20 pcs
PS-20009	0.5	4.2	12.9	8.75	
PS-20018	1	4.2	12.9	17.5	
PS-20027	15	4.2	12.9	26.25	
PS-20035	2	4.2	12.9	35.0	
PS-20053	3	4.2	12.9	52.5	1m
PS-20KN9	-	4.2	12.9	1m	

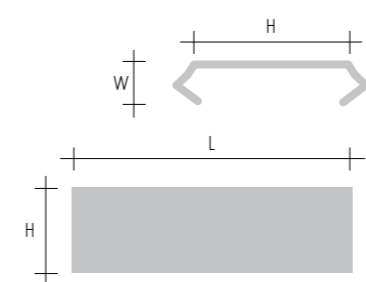

Transparent modules

TYPE	MODULE WIDTH	LENGTH (mm)	MARKER TAG	PACKAGING
PS-20009	0.5	8.75	PP+	20 pcs
PS-20018	1	17.5	PE, PFC, PP+	
PS-20027	15	26.25	PE, PFC, PP+	
PS-20035	2	35.0	PE, PFC, PP+	
PS-20053	3	52.5	PE, PFC, PP+	
PS-20KT	-	1m	PE, PFC, PP+	
PS-20KT	-	1m	PE, PFC, PP+	

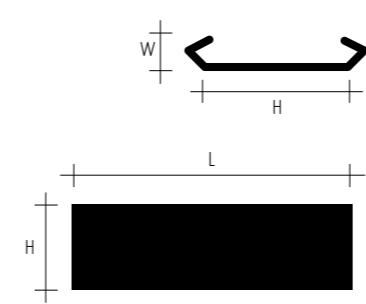

Base profile with adhesive

TYPE	LENGTH (m)	HEIGHT (mm)	THICKNESS (mm)	COLOUR	PACKAGING
PS-20BPS	1	11.6	3.0	black	10 m
PS-20BPV	1	11.6	3.0	white	10 m



+ INFORMATION

- + Flat profile made of PVC
- + Used with marker sleeves on wires (PT +, PTZ and PTC), cables (PM) or components (PS).
- + Material provides easy application
- + Developed for easy printing on site with Partek marking machines
- + PPA+ is a flat hard profile with adhesive tape for cabinet and component marking

+ PROPERTIES

Standard colour
yellow and white

TYPE	WIDTH (mm)	PACKAGING	APPLICATION
PP+046	4.6	17 m / 50 m	Phoenix Contact* terminal blocks
PP+063	6.3	17 m / 50 m	Phoenix Contact terminal blocks
PP+090	9.0	17 m / 50 m	PM-20, PTM20, PS
PP+100	10.2	17 m / 50 m	ABB Entrelec terminal blocks
PP+110	11.0	17 m / 50 m	Wago (TopJobs) terminal blocks
PPA+090	9.0	10 m / 25 m	Flat profile with adhesive

* - UT2.5, UTTB2.5, ST4, DT2.5, QTC, DTI2.5

+ SIZES AND PACKAGING

+ RELATED PRODUCTS



PROMARK-T1000
PAGE 100



MK10
PAGE 106

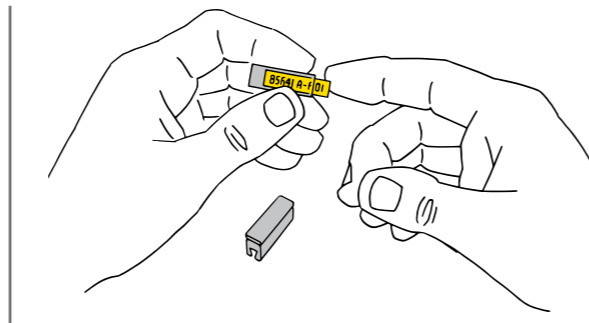

+ APPLICATION

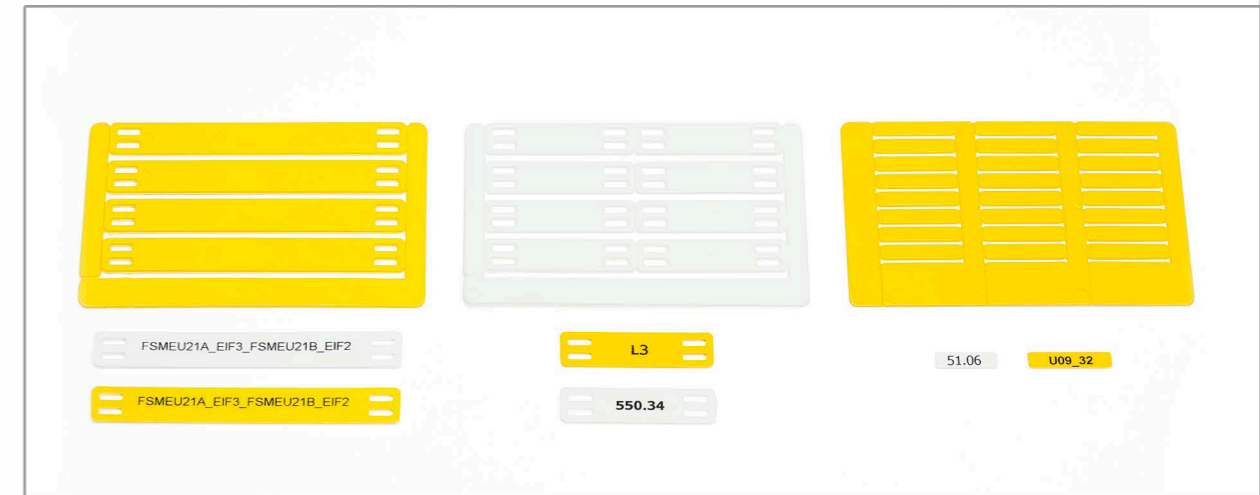

+ INFORMATION

- + Cards of different sizes for marking wires, cables and devices
- + For Partek holder systems PT+, PTZ+, PTC, PM and PS
- + Easy to separate in rigid polyester foil, specially pre-processed for printing
- + Enables a low cost 2-component solution together with Partek holder systems

+ PROPERTIES

Standard colour
yellow and white

+ SIZES AND PACKAGING

ARTICLE NUMBER	INFORMATION	MARKER TAG/LABEL LENGTH X HEIGHT (INCH)	QTY/CARD	QTY/BOX	MATERIAL	SUITABLE PARTEK HOLDER SYSTEM
PFC04212KA*	Marker tag - wire	12 x 4.2	21	525	ABS	PT+, PTZ+, PTC, PM,PTM
PFC04215KA*	Marker tag - wire	15 x 4.2	21	525	ABS	PT+, PTZ+, PTC, PM,PTM
PFC04218KA*	Marker tag - wire	18 x 4.2	21	525	ABS	PT+, PTZ+, PTC, PM,PTM
PFC04221KA*	Marker tag - wire	21 x 4.2	21	525	ABS	PT+, PTZ+, PTC, PM,PTM
PFC04230KA*	Marker tag - wire	30 x 4.2	14	350	ABS	PT+, PTZ+, PTC, PM,PTM
PFC07533KA*	Marker tag - cable	33 x 7.5	9	225	ABS	PTZ+15/25/35, PM20
PFC09518KA*	Marker tag - component / cable	18 x 9.5	20	500	ABS	PM24, PS20T
PFC09540KA*	Marker tag - cable marking	40 x 9.5	8	200	Polyamide/PA11	Cable tie mounting
PFC09580KA*	Marker tag - cable marking	80 x 9.5	4	100	Polyamide/PA11	Cable tie mounting

* = card colour (4: yellow, 9: white)

+ RELATED PRODUCTS



PRIMACY
PAGE 112



+ INFORMATION

- + Cassette for PA02- and PA1 sleeves
- + Flexible aid for service and maintenance marking
- + Pocket-sized.
- + Easy to refill from Partex standard range
- + CAS is double-sided for right and left mounting

+ ITEM DESCRIPTION

TYPE	CONTENTS	DIMENSIONS (mm)
CASS 600 B/W	Red Pocket Cassette containing 600 PA02 markers and one PUJ 4T Teflon coated applicator. Contains 50 of each marker 0,1,2 and 3, plus 25 of each 4-9 (incl), A,E,L,N,R,S,T,+,- and earth. The numbers, letters and symbols are black text on a white marker	67 x 90 x 21
CASS 600 C/C	As above but the numbers are colour coded (International resistor colour coding).	67 x 90 x 21
CASS 500 B/W	Blue Pocket Cassette containing 500 PA1 markers and one PUJ 5T Teflon coated applicator. Contains 25 of each marker 0-9 (inclusive), A, E, L, N, R, S, T, +, -, and earth. The numbers, letters and symbols are black text on a white marker.	67 x 90 x 21
CASS 500 C/C	As above but the numbers are colour coded (International resistor colour coding).	67 x 90 x 21

+ APPLICATION

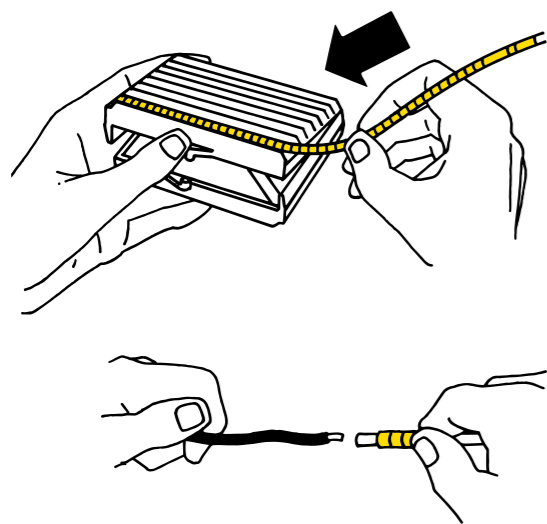

+ INFORMATION

- + The MD installation tool and MDH holder form a complete installation magazine for PA sleeves
- + The holder is easily loaded with the MD installation tool.
- + Complete marking kit for marking on site.
- + Minimize installation time and maximize flexibility when working with combination marking

+ ITEM DESCRIPTION

TYPE	CONTENTS	PACKAGING
MDH 20 B/W	Key ring dispenser complete with 20 wands each with 25 PA1 markers. Contains 25 of each marker 0-9 (inclusive), A, B, L, N, R, S, T, +, -, and earth. The numbers, letters and symbols are black text on a white marker.	1 pcs
MDH 20 C/C	As above but the numbers are colour coded (International resistor colour coding).	1 pcs
MDH 20E	Empty key ring dispenser (no wands)	1 pcs
MD10	Nylon replacement wand. No markers attached.	1 pcs
MD10 PA1	Nylon replacement wand complete with 25 PA1 markers. Please specify the number, letter or symbol you would like	1 pcs

+ APPLICATION

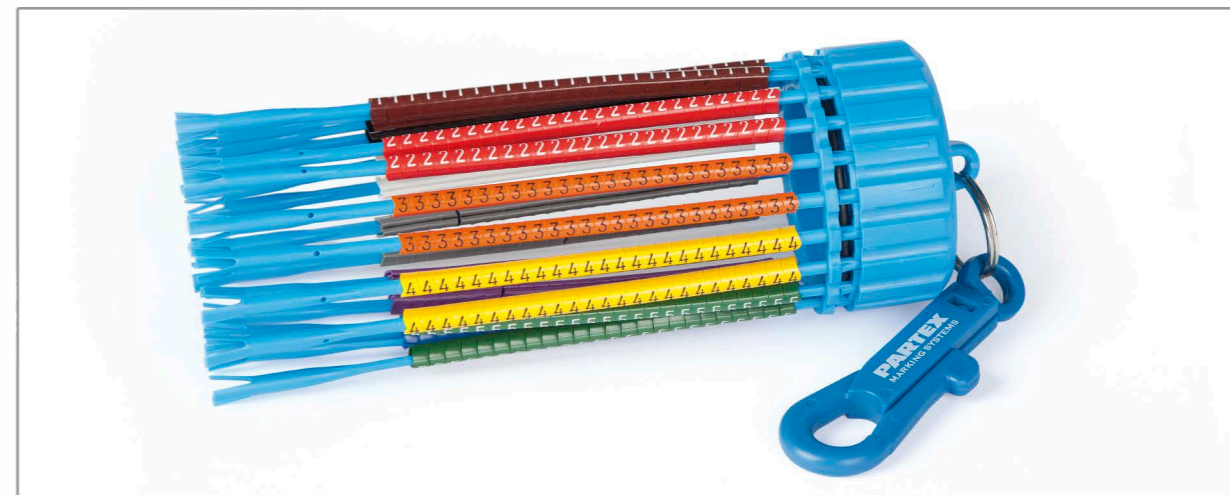
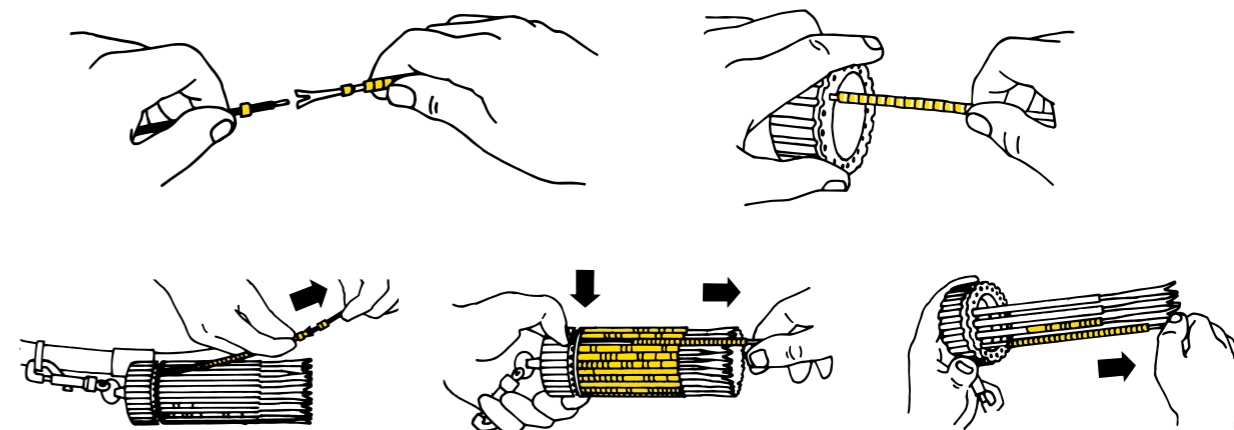



+ INFORMATION

- + Easy to use pocket sized dispenser with numbers or letters/symbols.
- + Contains 10 single-character adhesive tape rolls.
- + Complete marking kit for use on site.
- + Can be filled with any combination.

+ ITEM DESCRIPTION

TYPE	DESCRIPTION	PACKAGING
PLD-DIS-FULL	Key ring dispenser filled with one roll of each 0-9 (inclusive) black on white markers	1 pcs.
PLD-DIS-EMP	Empty dispenser	1 pcs.
PLD-CUTTER	Replacement serrated cutter	1 pcs.
PLD-REFILL	One roll of each 0-9 (inclusive) black on white markers. (Refill for dispenser)	1 pcs.
PLD-*	Ten rolls of a single ident black on white markers. *Please specify ident: A-Z, 0-9, +, -, /, earth, blank, L1, L2 and L3 available	1 pcs.

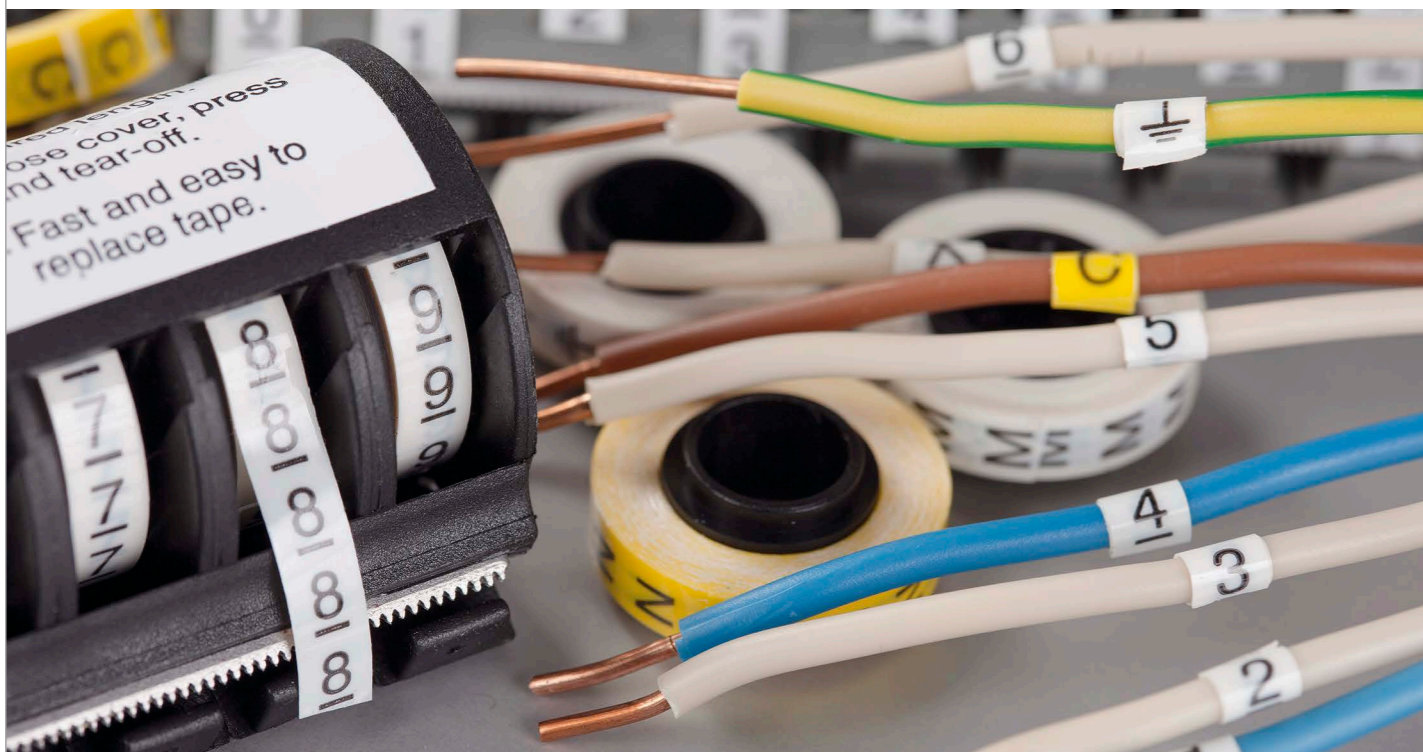

+ INFORMATION

- + Simplify marking of thin and stripped wires, excellent tools for combination marking
- + Shorten installation time

+ ITEM DESCRIPTION

TYPE	SIZE RANGE	FOR USE WITH	MATERIAL	COLOUR
MD 10	D: 0.5 to 2.5mm ²	PA1 and PZ1	Nylon	Light Blue
PUJ 1T	d: Smaller than 1.22mm D: Up to 0.22mm ²	PY01		Green
PUJ 3T	d: 1.5 to 2.4mm D: 0.34 up to 0.5mm ²	PA02 and PZ02	Teflon Coated	Red
PUJ 4T	d: 2.5 to 3.4mm D: 0.75 up to 1.5mm ²	PA02, PZ02, PA1 and PZ1	Stainless Steel	Dark Blue
PUJ 5T	d: 3.5 to 4.3mm D: 1.5 and 2.5mm ²	PA1 and PZ1		Light Blue

d: = The overall cable diameter D: = The cable size Size shown refers to BS6231 tri-rated cable

+ APPLICATION

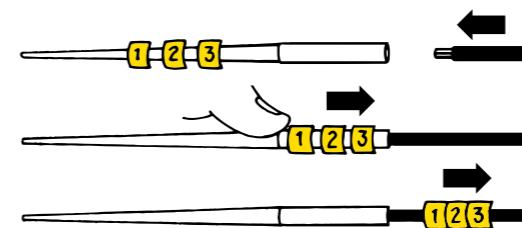



+ INFORMATION

- + Purpose designed 18 compartment boxes in impact resistant plastic.
- + On-site combination marking at a glance and at your fingertips.
- + Transparent lid ensures high visibility of contents.

+ ITEM DESCRIPTION

TYPE	CONTENTS	PACKAGING
PAL/B	Empty 18 Compartment Storage Box	1 pcs.
PAL PY B/W	PAL/B Box Containing 4500 PY 01 Markers. Contains 250 of each marker 0-9 (inclusive), L, N, R, S, T, +, -, and earth. The numbers, letters and symbols are black text on a white marker.	1 pcs.
PAL PY C/C	As above but the numbers are colour coded (International resistor colour coding).	1 pcs.
PAL 02 B/W	PAL/B Box Containing 4500 PA 02 Markers. Contains 250 of each marker 0-9 (inclusive), L, N, R, S, T, +, -, and earth. The numbers, letters and symbols are black text on a white marker.	1 pcs.
PAL 02 C/C	As above but the numbers are colour coded (International resistor colour coding).	1 pcs.
PAL 1 B/W	PAL/B Box Containing 4500 PA 1 Markers. Contains 250 of each marker 0-9 (inclusive), L, N, R, S, T, +, -, and earth. The numbers, letters and symbols are black text on a white marker.	1 pcs.
PAL 1 C/C	As above but the numbers are colour coded (International resistor colour coding).	1 pcs.
PAL 2 B/W	PAL/B Box Containing 1800 PA 2 Markers. Contains 100 of each marker 0-9 (inclusive), L, N, R, S, T, +, -, and earth. The numbers, letters and symbols are black text on a white marker.	1 pcs.
PAL 2 C/C	As above but the numbers are colour coded (International resistor colour coding).	1 pcs.



+ INFORMATION

- + Purpose designed 50 compartment boxes in impact resistant plastic.
- + On-site combination marking at a glance and at your fingertips.
- + Transparent lid ensures high visibility of contents.

+ ITEM DESCRIPTION

TYPE	CONTENTS	PACKAGING
PAL/50	Empty 50 Compartment Storage Box with removable compartments.	1 pcs.
PAL 50 PA02 B/W	PAL 50 Box Containing 5000 loose PA02 Markers and 1 PUJ 4T Teflon Coated Stainless Steel Applicator. Contains 200 of each number 0-9 (inclusive) and 100 of each letter A-Z (inclusive) +, -, / and earth. The numbers, letters and symbols are black text on a white marker.	1 pcs.
PAL 50 PA02 C/C	As above but the numbers are colour coded (International resistor colour coding).	1 pcs.
PAL 50 PA1 B/W	PAL 50 Box Containing 5000 loose PA1 Markers and 1 PUJ 5T Teflon Coated Stainless Steel Applicator. Contains 200 of each number 0-9 (inclusive) and 100 of each letter A-Z (inclusive) +, -, / and earth. The numbers, letters and symbols are black text on a white marker.	1 pcs.
PAL 50 PA1 C/C	As above but the numbers are colour coded (International resistor colour coding).	1 pcs.
PAL 50 PA2 B/W	PAL 50 Box Containing 5000 loose PA2 Markers. Contains 200 of each number 0-9 (inclusive) and 100 of each letter A-Z (inclusive) +, -, / and earth. The numbers, letters and symbols are black text on a white marker.	1 pcs.
PAL 50 PA2 C/C	As above but the numbers are colour coded (International resistor colour coding).	1 pcs.

SRC-T CARDBOARD BOX FOR MARKER REELS



+ INFORMATION

- + Cardboard dispenser box for Partex compacta discs
- + Ideal for storing a selection of Partex markers
- + On-site combination marking at a glance and at your fingertips

+ DIMENSIONS

SRC-T can hold 12 reels of PA02, 10 reels of PA1, 7 reels PA2, 5 reels PK+

TYPE	LENGTH (L mm)	WIDTH (W mm)	HEIGHT (H mm)	COMPARTMENTS
SRC-T	130	80	130	1

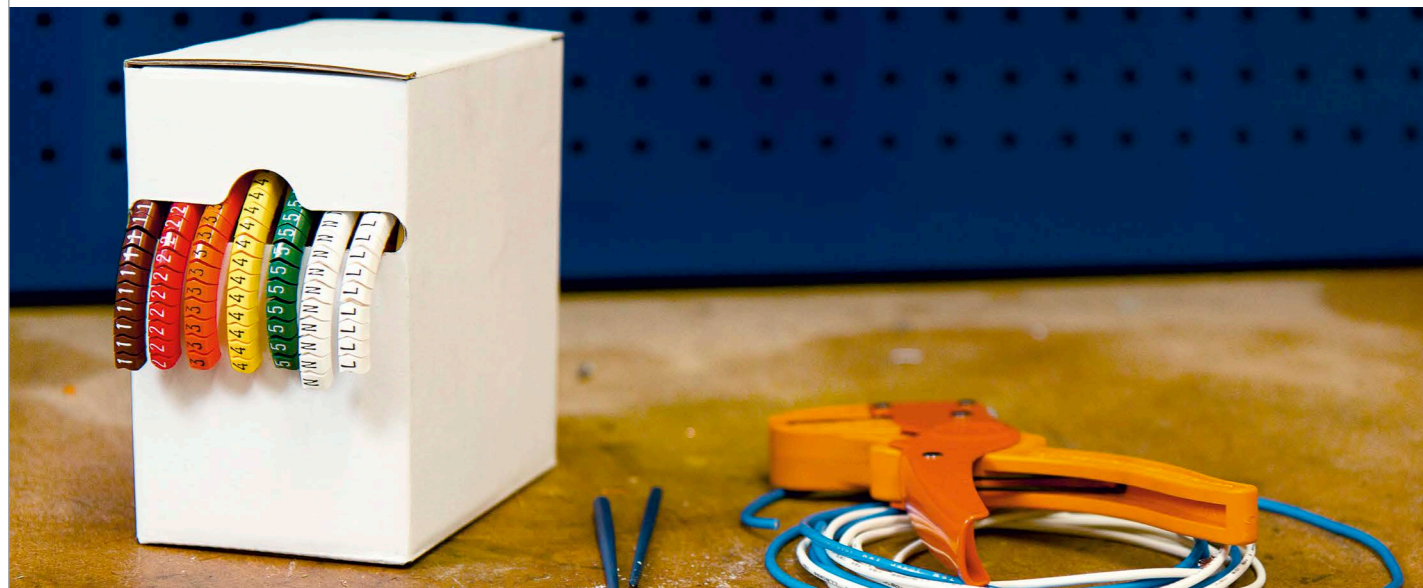
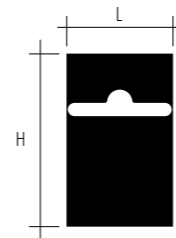

SRP - STEEL BOX FOR MARKER REELS



+ INFORMATION

- + Robust steel plate storage box for Partex compacta discs
- + Detachable upper tray for cable accessories
- + Flexible carrying handle
- + Holes for different suspension arrangements
- + An excellent accessory which simplifies marking work

+ PROPERTIES AND DIMENSIONS

SRP can hold 14 disks PA-2 or 11 disks PK+

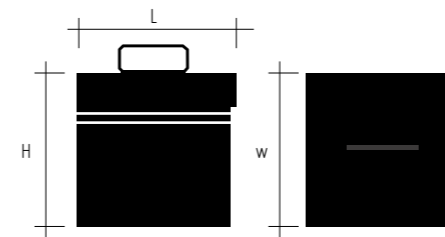

TYPE	LENGTH (mm)	WIDTH (mm)	HEIGHT (mm)	COMPARTMENTS
SRP	160	160	163	6 + place for discs





+ INFORMATION

- + Flexible spiral tube for fitting cables, conductors, tubes, wire bundles etc.
- + Excellent protection against mechanical wear
- + Permits flexible connection between cabinet and door mounted units
- + Also available in halogen free version (SPZ)
- + Snap-on fastener for holding tube into mounting plate holes.

+ PROPERTIES

Temperature range
-30°C to +60°C

Material
PVC

Standard colour
grey, black

Fixing
snap-into fastener of spiral tube in holed mounting plates

+ DIMENSIONS AND PACKAGING

TYPE	INTERNAL DIAMETER [mm]	OUTSIDE DIAMETER [mm]
SP-08	8	10
SP-10	10	13
SP-15	15	18.4
SP-20	20	24
SP-25	25	29
SP-30	30	34.6
SP-40	40	45
SP-50	50	55

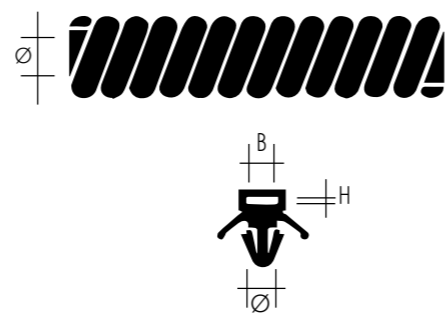

+ MOUNTING

TYPE	MAX. THICKNESS PLATE	MOUNTING HOLE	PACKAGING
SPH-1	3.2 mm	6.2 mm	50 pcs.

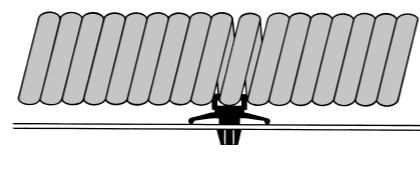

+ APPLICATION

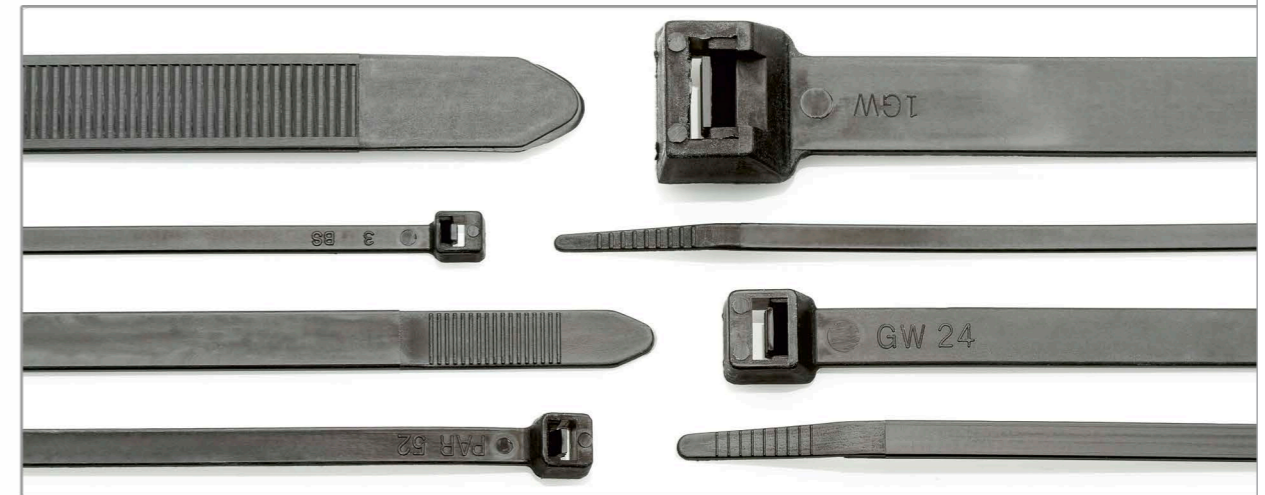

+ INFORMATION

- + Handy to use with Partex PK+ and PO sleeves and PM, PKH/POH holders
- + Self-locking with high fixing strength.
- + Available for indoor and outdoor installation.
- + An extensive range of products to suit many applications.

+ PROPERTIES AND DIMENSIONS

Temperature range
-40°C to +85°C

Material
Nylon 6.6, in accordance with UL94-V2
UV resistant ties are also available.

Standard colour
Black and Natural.



+ DIMENSIONS AND PACKAGING

STANDARD CABLE TIES

TYPE	LENGTH (mm)	WIDTH (mm)	MAX BUNDLE DIAMETER (mm)	MIN. TENSILE STRENGTH (kg)	PACKAGING
HFC 80	80	2.5	15	8	100 or 1000
HFC 100	100	2.5	18	8	100 or 1000
HFC 120	120	4.8	24	22	100 or 1000
HFC 140	140	3.6	33	18	100 or 1000
HFC 160	160	4.8	38	22	100 or 1000
HFC 200	200	4.8	50	22	100 or 1000
HFC 250	250	4.8	50	22	100
HFC 300	300	4.8	76	22	100
HFC 365	365	4.8	102	22	100
HFC 430	430	4.8	110	22	100
HFC 530	530	4.8	140	22	100
HFC 160L	160	2.5	40	8	100 or 1000
HFC 200L	200	2.5	50	8	100 or 1000
HFC 200I	200	3.6	50	18	100 or 1000
HFC 300L	300	3.6	76	18	100
HFC 150H	150	7.6	36	55	100
HFC 200H	200	7.6	50	55	100
HFC 240H	240	7.6	66	55	100
HFC 300H	300	7.6	76	55	100
HFC 370H	370	7.6	100	55	100
HFC 430H	430	9.0	110	75	100
HFC 530H	530	9.0	140	75	100
HFC 710H	710	9.0	190	75	100
HFC 940H	940	9.0	280	75	100
HFC 1220H	1220	9.0	375	75	100
HFC 580EH	580	12.7	152	113	100

Available in both black and natural, please specify required colour when ordering.



UV RESISTANT CABLE TIES FOR OUTDOOR USE

TYPE	LENGTH (mm)	WIDTH (mm)	MAX BUNDLE DIAMETER (mm)	MIN. TENSILE STRENGTH (kg)	PACKAGING
HFC 100 UVB	100	2.5	18	8	100
HFC 140 UVB	140	3.6	33	18	100
HFC 200 UVB	200	4.8	50	22	100
HFC 300 UVB	300	4.8	76	22	100
HFC 365 UVB	365	4.8	102	22	100
HFC 530 UVB	530	4.8	140	22	100
HFC 160L UVB	160	2.5	40	8	100
HFC 200I UVB	200	3.6	50	18	100
HFC 300L UVB	300	3.6	76	18	100
HFC 300H UVB	300	7.6	76	55	100
HFC 370H UVB	370	7.6	100	55	100
HFC 710H UVB	710	9.0	190	75	100
HFC 1030EH UVB	1030	12.7	302	113	100

Only available in black.



+ DIMENSIONS AND PACKAGING

IDENTIFICATION CABLE TIES

TYPE	LENGTH (mm)	WIDTH (mm)	MAX BUNDLE DIAMETER (mm)	MIN. TENSILE STRENGTH (kg)	MAKING TAG SIZE (mm)	PACKAGING
MAR100F	98	2.5	20	8	8 x 25	100
MAR110F	110	2.5	20	8	9 x 20	100
MAR200W	194	4.8	45	22	27 x 13	100

Available in natural, MAR200W also available in yellow. Please specify required colour when ordering.

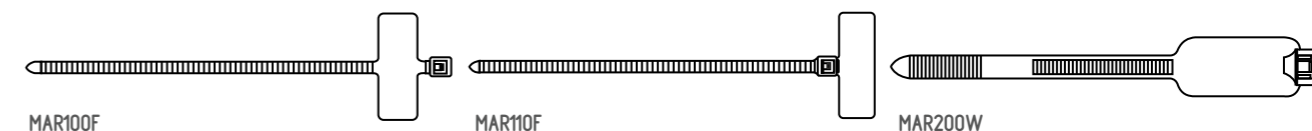

STAINLESS STEEL CABLE TIE MOUNTS

TYPE	LENGTH (mm)	WIDTH (mm)	MAX. TIE WIDTH (mm)	FIXING HOLE SIZE	PACKAGING
SSTM4	29.2	15.0	10.0	M4	100
SSTM6	29.2	15.0	10.0	M6	100



+ TIE TENSIONING TOOLS

NYLON CABLE TIE TENSIONING TOOL

- + Automatically tensions and cuts the tie flush to the head leaving no sharp edges. Automatic
- + Ergonomic handle reduces operator fatigue.
- + Adjustable tension setting.
- + Only suitable for nylon cable ties.

TYPE	TIE CUTTING	MAXIMUM TIE WIDTH	TENSION SETTINGS
TT1	Automatic	4.8 mm	Adjustable 2.5 to 14 kgs



STAINLESS STEEL TIE TENSIONING TOOL

- + Automatically tightens and cuts off the tie when it reaches the required tension.
- + Adjustable tension setting. Ergonomic handle reduces operator fatigue.
- + Only suitable for stainless steel cable ties.

TYPE	TIE CUTTING	MAXIMUM TIE WIDTH	TENSION SETTINGS
SSTG	Automatic	7.9 mm	Adjustable 31 to 65 kgs



STAINLESS STEEL TIE TENSIONING TOOL

- + A semi-automatic tool which tightens the tie to the required tension with a manual cutting mechanism.
- + Easy to use and very robust it is ideal for high volume applications.
- + Only suitable for stainless steel cable ties.

TYPE	TIE CUTTING	MAXIMUM TIE WIDTH	TENSION SETTINGS
SSAT	Manual	7.6 mm	Fixed



SST - STAINLESS STEEL CABLE TIES

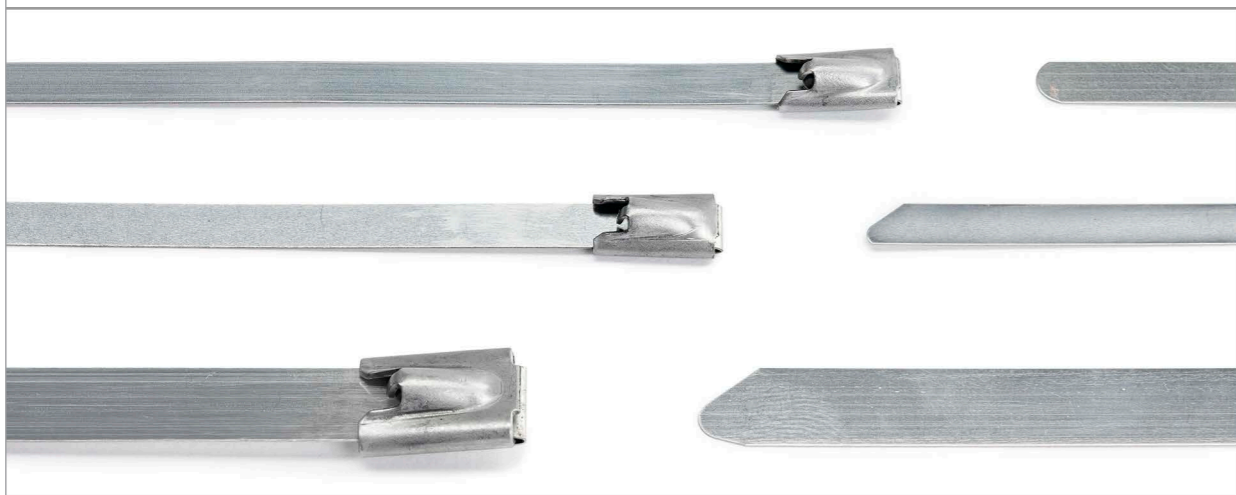

+ INFORMATION

- + Cable ties made from stainless steel AISI 316
- + Great for restraining harnesses and cables. Quick and safe installation in a variety of applications
- + Easy to clamp with Partex's tools: SSTG or SSAT
- + Excellent resistance to acids, salt, chemicals, and high temperatures

+ SIZES AND PACKAGING

TYPE	DESCRIPTION	SIZE (mm)	MAXIMUM DIAMETER (mm)	PACKAGING	MINIMUM TENSILE STRENGTH N
SST1316	stainless steel cable tie	150 x 4.6	43	100 pcs	445
SST2316	stainless steel cable tie	200 x 4.6	59	100 pcs	445
SST3316	stainless steel cable tie	260 x 4.6	78	100 pcs	445
SST3816	stainless steel cable tie	300 x 4.6	85	100 pcs	445
SST4316	stainless steel cable tie	360 x 7.9	110	100 pcs	1112
SST5316	stainless steel cable tie	520 x 4.6	161	100 pcs	445
SST6316	stainless steel cable tie	680 x 4.6	200	100 pcs	445



SSTC - STAINLESS STEEL CABLE TIES, COATED

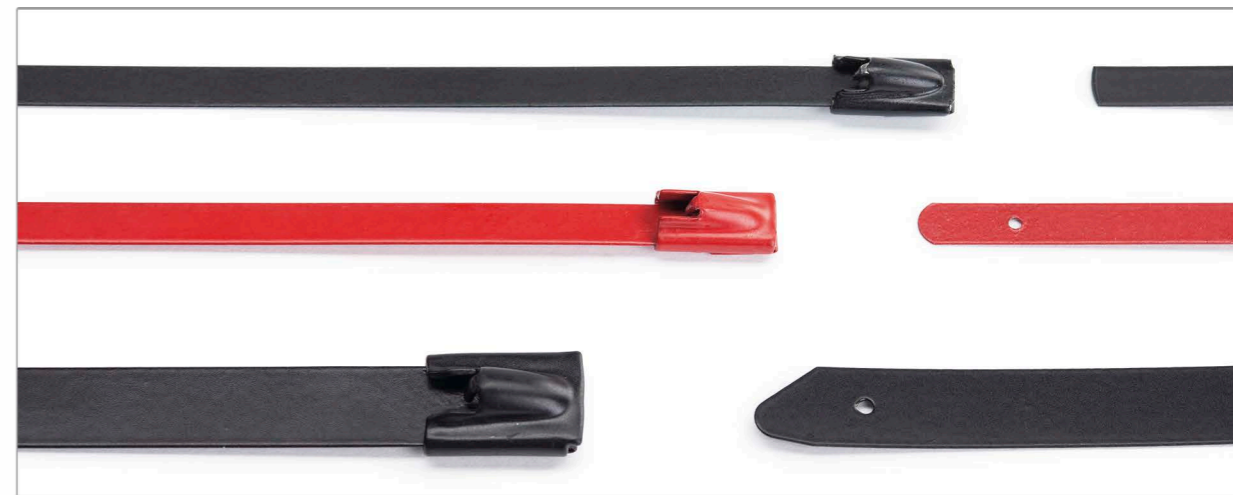

+ INFORMATION

- + Cable ties made from stainless steel AISI 316, coated with black or red polyester.
- + A very strong ball lock.
- + Quick and safe installation in a variety of applications.
- + The outer layer of polyester and gently rounded edges protect the cable from damage.
- + Excellent resistance to acids, salt, chemicals, and high temperatures.

+ SIZES AND PACKAGING

TYPE	DESCRIPTION	SIZE (mm)	MAXIMUM DIAMETER STRIPS (mm)	PACKAGING	MINIMUM TENSILE STRENGTH N
SSTC1316	coated stainless steel cable ties	150 x 4.6	43	100 pcs	445
SSTC2316	coated stainless steel cable ties	200 x 4.6	59	100 pcs	445
SSTRC2316	coated stainless steel cable ties red	200 x 4.6	59	100 pcs	445
SSTC3316	coated stainless steel cable ties	260 x 4.6	78	100 pcs	445
SSTC3816	coated stainless steel cable ties	300 x 4.6	85	100 pcs	445
SSTC4316	coated stainless steel cable ties	360 x 4.6	110	100 pcs	445
SSTRC4316	coated stainless steel cable ties red	360 x 4.6	110	100 pcs	445
SSTC5316	coated stainless steel cable ties	360 x 7.9	161	100 pcs	445
SSTC6316	coated stainless steel cable ties	680 x 4.6	200	100 pcs	445





+ INFORMATION

- + Compact, fast and portable printer to cover most of your marker needs.
- + Easy to operate with Partex product menu.
- + Feeds, prints and cuts bulk Partex profiles and self adhesive labels.
- + Store and import markerfiles with a USB - PC connection.
- + Cost effective identification system for use in panel building and electrical installations.

+ PROPERTIES

Temperature range

Operating temperature: +15°C - +32,5°C
 Operating temperature with pre-heater: from +5°C
 Storage temperature: +5°C - +35°C
 To obtain the best printing result, the temperature of the profile shouldn't be lower than: +20°C

Thermal transfer printing

300 dpi print resolution

Printing speed

18.5 mm/s - low speed mode
 25 mm/s - standard mode
 40 mm/s - high speed mode

Text heights

13, 2, 3, 4 or 6mm

Maximum rows that can be printed:

1-3 rows

PC connection

USB 2.0 and Partex software WinSign

Internal Memory

15000 characters

Number of characters to be sent to PC

No limits with WinSign T-1000

Power

Power Supply 100 ~ 240 V AC (50 ~ 60 Hz)
 Power: 13 W
 Certified with CE mark

Dimensions

(L x W x H): 250 x 300 x 85 mm

Weight

2 kg

+ KIT CONTENTS

- + PROMARK T-1000, soft carrying case,
- + AC adapter, power cord,
- + Ink ribbon, black, 40 m,
- + Profile guide
- + USB cable,
- + software,

+ SPECIFICATION

- + ProMark T1000 is a successor to our most popular profile printer the T800. Complemented with new options, such as Polish and Russian font, and menu with Partex article numbers, is a perfect solution for installers and producers of control cabinets and panel boards
- + Low weight, small size, as well as inbuilt memory allow you to operate the printer on site. The library of electrical symbols enables you to print objects such as Ω, etc.
- + An additional asset will be the menu with Partex products indexes. After selecting the type of a profile, T-1000 will automatically choose the position of text and the depth of the cut.
- + The backlit display and QWERTY keyboard allows entering additional symbols very quickly. The advanced projects can be sent to T-1000 via the new, English version of WinSign software, which enables you to import Excel files with the "copy and paste" function.

+ PROFILES TO PRINT

- + PO and POZ profiles with diameters of 1.3 - 5.5 mm (POZ is the halogen-free version)
- + PHZ - round, halogen-free, heat shrinkable tubes with diameters 2.4 - 6.4 mm before shrinking
- + PHZF - flat, halogen-free, heat shrinkable tubes with diameters 2.4 - 6.4 mm before shrinking
- + PP+ profile - height of 4.6 and 9.0 mm compatible with profiles: PT+/PTC/PTZ and PM, PTM, PS
- + PP+ profile - height of 6.3, 10.0 and 11.0 mm compatible with Wago connectors (TopJobs), Phoenix Contact, ABB Entreltec.
- + PPA+ - self-adhesive profile
- + PO-068 profile - used for marking cables with PKH and POH holders
- + PROMARK-PLL - self laminating marker for wires and cables
- + PROMARK-PL - adhesive tape with a width of 6mm, 9mm and 12mm available in the form of cassettes which you place into the printer

+ ACCESSORIES

TYPE	DESCRIPTION
PROMARK-RB-BLACK	black ribbon 100 m
PROMARK-RB-WHITE	white ribbon 85 m
PROMARK-CU	cutting unit
PROMARK-TA	tube attachment
PROMARK-TA-CLEAN	cleaning kit guide for tube attachment (3 pcs)
PROMARK-PA	plate attachment
PROMARK-PA-CLEAN	cleaning kit guide for plate attachment (3 pcs)
PROMARK-TW	profile warmer
PROMARK-TW-CLEAN	cleaning kit guide for the profile warmer (3 pcs)
PROMARK-AF	profile feeder
PROMARK-HC	aluminium case
MK-STV	reel stand
MK-RS3	small reel stand



MK-STV



MK-RS3



PROMARK-HC

+ PO-PROFILE

TYPE	HALOGEN FREE VERSION	DIAMETER [mm] [min/max]	CROSS SECTIONAL AREA [mm²]	PACKAGING
PO-01	POZ01	13/18	0.25	6 m / 250 m
PO-02	POZ02	17/22	0.5	5 m / 60 m / 250 m
PO-03	POZ03	2.0/2.5	0.75	4.5 m / 50 m / 250 m
PO-04	POZ04	2.2/2.8	1.0	4.5 m / 50 m / 200 m
PO-05	POZ05	2.7/3.5	1.5	4 m / 40 m / 200 m
PO-06	POZ06	3.2/4.0	2.5	3.5 m / 40 m / 200 m
PO-06Q**	-	-	-	3.5 m / 40 m
PO-068Q**	PKZ20Q	-	-	25 m / 50 m
PO-068TW	PKZ20	6.8/7.0	-	4.5 m / 50 m
PO-07	POZ07	3.8/4.7	4.0	3.5 m / 30 m / 100 m
PO-08	POZ08	4.6/5.5	6.0	3 m / 30 m / 100 m



PO/POZ
▶ PAGE 28



PO-068
▶ PAGE 28

STANDARD COLOUR: yellow, white. Others on request * Mounting with marker holder POH or PKH ** Mounting with cable tie

+ HEATSHRINKABLE TUBES PHZ

TYPE	DIAMETER BEFORE SHRINKING [mm]	DIAMETER AFTER SHRINKING [mm]	PACKAGING
PHZ20024	2.4	1.2	15 m or 100 m
PHZ20032	3.2	1.6	15 m or 100 m
PHZ20048	4.8	2.4	12 m or 100 m
PHZ20064	6.4	3.2	12 m or 100 m



PHZ
▶ PAGE 32

STANDARD COLOURS: yellow, white. Other on request

+ FLAT HEATSHRINKABLE TUBES PHZF

TYPE	DIAMETER BEFORE SHRINKING [mm]	DIAMETER AFTER SHRINKING [mm]	PACKAGING
PHZF20024	2.4	1.2	100 m / 25 m
PHZF20032	3.2	1.6	100 m / 25 m
PHZF20048	4.8	2.4	100 m / 25 m
PHZF20064	6.4	3.2	100 m / 25 m



PHZF
▶ PAGE 34

STANDARD COLOURS: yellow, white. Other on request



+ PP+ PROFILE

TYPE	HEIGHT [mm]	FIT FOR	PACKAGING
PP+046	4.6	PT+, PTC, PTZ, PM-10	50 m / 17 m
PP+063	6.3	terminals Phoenix Contact *	50 m / 17 m
PP+09	9.0	PM-20, PS	50 m / 17 m
PP+100	10.2	terminals ABB Entelec	50 m / 17 m
PP+110	11.0	terminals Wago (TopJobs)	50 m / 17 m
PPA+09	9.0	components	20 m / 10 m

STANDARD COLOURS: yellow, white * UT2.5, UTTB2.5, ST4, DT2.5, QTC, DTI2.5



PT+
▶ PAGE 48



PTC
▶ PAGE 50



PM
▶ PAGE 52



PS
▶ PAGE 82



PPA+
▶ PAGE 84



PP+
▶ PAGE 84

+ SELF ADHESIVE LABELS

TYPE	HEIGHT [mm]	COLOUR	LENGTH [m]	PACKAGING
PROMARK-PL060	6	yellow, white silver	30	1 cassette
			30	
			27	
PROMARK-PL090	9	yellow, white silver	30	1 cassette
			30	
			27	
PROMARK-PL120	12	yellow, white silver	30	1 cassette
			27	
PROMARK-PLL33	33 (printable area 10)	white	8	1 cassette



PROMARK-PL



PROMARK-PLL





+ INFORMATION

- + Small table printer for high demand production of Partex PPQ, ProSleeve and other profiles.
- + Cost effective identification system for use in panel building and electrical installations.
- + Feeds and prints Partex profiles and labels.
- + Connected to a PC and controlled by Partex WinSign software.

+ PROPERTIES

Temperature range

Operating temperature: +5°C to +40°C
Humidity: 10 - 85 % not condensing

To obtain the best printing result, the temperature of the profile shouldn't be lower than +25°C

Thermal transfer printing

300 dpi print resolution

Power supply

100 - 240V (50-60Hz) max 300 W

PC connection

USB 2.0 connection and Partex WinSign software.

Dimensions

189x322x253mm (H x W x D)

Printing speed

125 mm/s

Weight

4,0 kg

+ PRINTER AND ACCESSORIES

ARTICLE NUMBER	INFORMATION	PACK UNIT (MOQ)
EOS1	Printer EOS1, USB cable, mains lead.	1pce
MK-STV	Reel stand for small reels	1pce
MK-RS3	Small reel stand, mountable	1pce





* pictured with optional cutting unit

+ INFORMATION

- + Compact heavy duty printer for high demand production for wire, cable and component marking
- + Feeds, prints and cuts bulk Partex profiles
- + MK10 is a very cost effective identification system for use in panel building and electrical installations
- + USB connection, controlled by Partex WinSign software

+ PROPERTIES

Temperature range

Operating temperature: 15°C - 35°C

Storage temperature: 0°C - 40°C

To obtain the best printing result, the temperature of the profile shouldn't be lower than: 20 - 25°C

Thermal transfer printing

300 dpi print resolution

Printing speed

125 mm/s

Width of printing head

105 mm

PC connection

USB and Partex WinSign software

Operating System

Windows: 2000, 2003, XP, Vista, Windows 7

Memory

64 MB RAM

Power

110-240 V AC, (50-60 Hz)

Certified with CE mark

Dimensions

(W x D x H): 242 x 446 x 275 mm

Weight

9 kg

+ KIT CONTENTS

- + printer MK10,
- + cutter,
- + power cord,
- + Starting ribbon black 360 m,
- + USB cable,
- + WinSign software



+ SPECIFICATION

- + MK10 is a modern thermal transfer printer with a high production speed (up to 125mm/sec).
- + MK10 is connected to your computer with a USB cable and controlled by Partex WinSign software
- + It prints onto the profile directly from the reel, and can cut the markers to the required length.

+ PROFILES TO PRINT

- + PO and POZ profiles with diameters of 1.3 - 7.0mm (POZ is the halogen-free version)
- + PHZF - flat, halogen-free, heat shrinkable tubes with diameters 2.4 - 25.4 mm before shrinking
- + PP+ profile - height of 4.6 and 9.0 mm compatible with profiles: PT+/PTC/PTZ and PM, PTM, PS
- + PP+ profile - height of 6.3, 10.0 and 11.0 mm compatible with Wago connectors (TopJobs), Phoenix Contact, Etrelec
- + PPA+ - self-adhesive profile
- + PO-068 profile - used for marking cables with PKH and POH holders
- + Labels

+ ACCESSORIES



MK-STV
Reel stand

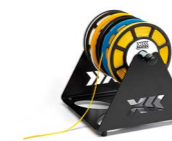

MK-RS3
Small reel stand



MK10-CU
Cutting



RIBBONS
PAGE 81



* pictured with optional cutting unit

+ INFORMATION

- + Prints on both sides of the profile. (Dual printing heads)
- + Compact heavy duty printer for high demand production of wire, cable and component markings
- + Feeds, prints and cuts bulk Partex profiles
- + USB connection, controlled by Partex WinSign software

+ PROPERTIES

Temperature range

Operating temperature: +10°C to +35°C

To obtain the best printing result, the temperature of the profile shouldn't be lower than: +25 °C

Working conditions:

Humidity: 30 - 85 %

Thermal transfer printing

300 dpi print resolution

Width of printing head

105 mm

PC connection

USB and Partex software WinSign

Power supply

100 ~ 240V (50-60Hz)

Power consumption: Max 300 W

CE-certified

Dimensions

(L x W x H): 554 x 248 x 395 mm

Weight

21 kg

+ KIT CONTENTS

- + MK10-DH,
- + power cord,
- + Starting ribbon black 360 m,
- + USB cable
- + WinSign software

+ ACCESSORIES



MK-STV
Reel stand

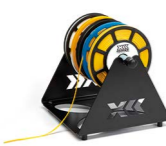

MK-RS3
Small reel stand

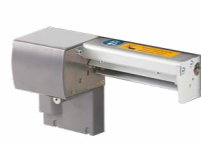

MK10-CU
Cutting

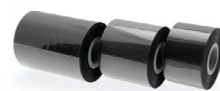

RIBBONS
PAGE 81



+ SPECIFICATION

- + MK10-DH is a modern thermal transfer printer with a high production speed (up to 125mm/sec).
- + MK10-DH can be connected directly to a computer with a USB cable and is controlled by Partex Winsign software. It prints onto both sides of the profile, direct from the reel, and can cut the markers to the required length.



+ PO-PROFILE

TYPE	HALOGEN FREE VERSION	DIAMETER [mm] [min/max]	CROSS SECTIONAL [mm ²]	PACKAGING
PO-01	POZ01	13/18	0.25	6 m / 250 m
PO-02	POZ02	17/22	0.5	5 m / 60 m / 250 m
PO-03	POZ03	20/25	0.75	4.5 m / 50 m / 250 m
PO-04	POZ04	2.2/2.8	10	4.5 m / 50 m / 200 m
PO-05	POZ05	2.7/3.5	15	4 m / 40 m / 200 m
PO-06	POZ06	3.2/4.0	25	3.5 m / 40 m / 200 m
PO-06Q**	-	-	-	3.5 m / 40 m
PO-068Q**	PKZ20Q	-	-	25 m / 50 m
PO-068TW	PKZ20	6.8/7.0	-	4.5 m / 50 m
PO-07	POZ07	3.8/4.7	4.0	3.5 m / 30 m / 100 m
PO-08	POZ08	4.6/5.5	6.0	3 m / 30 m / 100 m
PO-09	POZ09	5.6/7.0	10.0	50 m
PO-10	POZ10	6.5/8.0	16.0	50 m



PO/POZ

▶ PAGE 28



PO-068

▶ PAGE 28

STANDARD COLOUR: yellow, white. Others on request * Mounting with marker holder POH or PKH ** Mounting with cable tie

+ FLAT HEATSHRINKABLE TUBES PHZF

TYPE	DESCRIPTION	PACKAGING
PHZF20024	flat heat shrink 2.4 / 1.2 mm	100 m / 25 m
PHZF20032	flat heat shrink 3.2 / 1.6 mm	100 m / 25 m
PHZF20048	flat heat shrink 4.8 / 2.4 mm	100 m / 25 m
PHZF20064	flat heat shrink 6.4 / 3.2 mm	100 m / 25 m
PHZF20095	flat heat shrink 9.5 / 4.8 mm	75 m
PHZF20127	flat heat shrink 12.7 / 6.4 mm	50 m
PHZF20190	flat heat shrink 19.0 / 9.5 mm	50 m
PHZF20254	flat heat shrink 25.4 / 12.7 mm	50 m
PHZF20380	flat heat shrink 38.0 / 19.1 mm	50 m



PHZF

▶ PAGE 34

STANDARD COLOUR: yellow, white. Others on request

+ PP+ PROFILE

TYPE	HEIGHT [mm]	FIT FOR	PACKAGING
PP+046	4.6	PT+, PTC, PTZ, PM-10	50 m / 17 m
PP+10	10.2	terminals Phoenix Contact *	50 m / 17 m
PP+063	6.3	PM-20, PS	50 m / 17 m
PP+09	9.0	terminals ABB Entrelec	50 m / 17 m
PP+110	110	terminals Wago (TopJobs)	50 m / 17 m
PPA+09	9.0	components	20 m / 10 m

STANDARD COLOUR: yellow, white * UT2.5, UTTB2.5, ST4, DT2.5, QTC, DTI2.5



PT+

▶ PAGE 48



PTC

▶ PAGE 50



PM

▶ PAGE 52



PTM

▶ PAGE 54



PS

▶ PAGE 82



PP+

▶ PAGE 84

+ PPQ+

TYPE	HEIGHT [mm]	LENGTH [mm]	PACKAGING
PPQ+10040	10	40	500 pcs
PPQ+10060	10	60	333 pcs
PPQ+10080	10	80	250 pcs
PPQ+19040	19	40	500 pcs
PPQ+19060	19	60	333 pcs
PPQ+19080	19	80	250 pcs
PPQ+38060	38	60	333 pcs
PPQ+38080	38	80	250 pcs
PPQ+38100	38	100	200 pcs

STANDARD COLOUR: yellow, white. MOUNTED with cable tie



PPQ+

▶ PAGE 56





+ INFORMATION

- + Cost effective printing solution for Partex marker cards system.
- + Single sided printer for larger production volumes.
- + Prints onto Partex PFC-cards
- + Connected to a PC and controlled by Partex WinSign software .

+ PROPERTIES

Temperature range:

Operating temperature: +15°C to +30°C
Storage temperature: -5°C to +70°C

Operating humidity: 20% to 65% non-condensing
Storage humidity: 20% to 70% non-condensing

To obtain the best printing result, the temperature of the profile shouldn't be lower than +20°C

Thermal transfer printing

300 dpi print resolution

PC connection

USB (1.0, 1.1, 2.0, 3.0) and Partex WinSign software

Dimensions

247x205x381mm (HxWxD)

Printing speed

1000 cards/hour monochrome

+ PRINTER AND ACCESSORIES

+ ORDERING INFORMATION

ARTICLE NUMBER	INFORMATION	PACK UNIT (MOQ)
PRIMACY	Primacy card printer, black ribbon and cleaning kit.	1 pce
PRIMACY-RB-BK	Black ribbon for PFC cards made of ABS (2000 prints)	1 pce
PRIMACY-RB-BKFLEX	Black ribbon for PFC cards made of Polyamide (1000 prints)	1 pce
PRIMACY-ACL001	Regular cleaning kit, (5 cards with an adhesive side and 5 cleaning sticks)	1 pce
PRIMACY-ACL002	Advanced cleaning kit, (2 T-cards, 2 adhesive cleaning cards, 1 pen and 60 wipes)	1 pce

ARTICLE NUMBER	INFORMATION	MARKER TAG/LABEL LENGTH X HEIGHT (INCH)	QTY/CARD	QTY/BOX	MATERIAL	SUITABLE PARTEX HOLDER SYSTEM
PFC04-212KA*	Marker tag - wire	12 x 4.2	21	525	ABS	PT+, PTZ+, PTC, PM,PTM
PFC04-215KA*	Marker tag - wire	15 x 4.2	21	525	ABS	PT+, PTZ+, PTC, PM,PTM
PFC04-218KA*	Marker tag - wire	18 x 4.2	21	525	ABS	PT+, PTZ+, PTC, PM,PTM
PFC04-221KA*	Marker tag - wire	21 x 4.2	21	525	ABS	PT+, PTZ+, PTC, PM,PTM
PFC04-230KA*	Marker tag - wire	30 x 4.2	14	350	ABS	PT+, PTZ+, PTC, PM,PTM
PFC07533KA*	Marker tag - cable	33 x 7.5	9	225	ABS	PTZ+15/25/35, PM20
PFC09518KA*	Marker tag - component / cable	18 x 9.5	20	500	ABS	PM24, PS20T
PFC09540KA*	Marker tag - cable marking	40 x 9.5	8	200	Polyamide/PA11	Cable tie mounting
PFC09580KA*	Marker tag - cable marking	80 x 9.5	4	100	Polyamide/PA11	Cable tie mounting

* = card colour (4:yellow, 9:white)





+ INFORMATION

- + Software for Partex printers.
- + Create both direct marking and whole projects
- + Sends information to Partex's different printers to make it possible to produce markers on site
- + You can import files with marking information from Excel and some CAD systems e.g EPLAN and ELPRO

+ SYSTEM REQUIREMENTS

Computer
Processor - Pentium II
RAM memory - 256 MB
Hard drive - 200 MB free space

Runs with these operating systems
 Windows 2000
 Windows NT
 Windows ME
 Windows XP
 Windows Vista
 Windows 7



+ SPECIFICATION

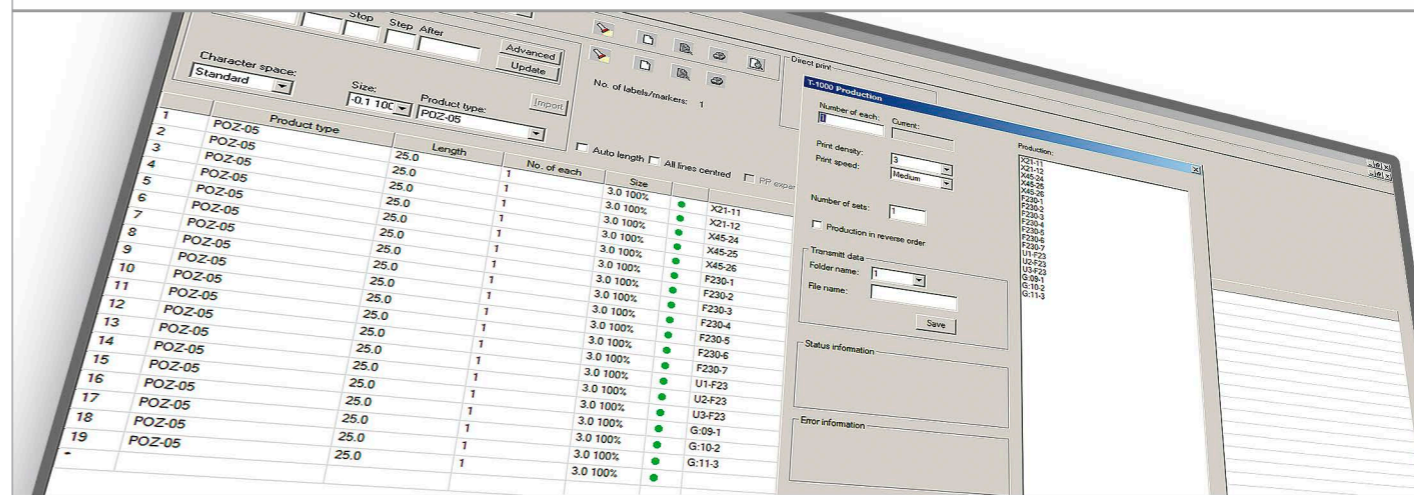

- + WinSign is an application that runs in Windows environment.
- + Full version WinSign -NG - controls the following devices: MK9- NG, T-1000, MK10, MK10-D, EOS1 and PRIMACY
- + Built-in database containing information on industrial documentation and all Partex marker types .
- + WinSign projects can consist of multiple groups, such as wire markers, component markers , and/or cable markers .
- + Project can be saved and restored later.
- + Easy to use import and number generation functions ensures efficient marker production.

+ RELATED PRODUCTS





PARTEX MARKING SYSTEMS (UK) LTD

61-64 Station Road
Coleshill, Birmingham
B46 1JT UK
phone: +44 (0)1675 463670, Fax: +44 (0)1675 463520
email: sales@partex.co.uk

X-ON Electronics

Largest Supplier of Electrical and Electronic Components

Click to view similar products for [Wire Labels & Markers](#) category:

Click to view products by [Partex](#) manufacturer:

Other Similar products are found below :

[89078GBEST](#) [89082GBESR](#) [89082GBEST](#) [PCL025-4](#) [5761-2SF](#) [586R734H02](#) [CS1836-000](#) [CS8626-000](#) [CU6337-000](#) [CU6343-000](#)
[CWD01-0](#) [CWD012-0](#) [CWD012-7](#) [CWD015-3](#) [CWD015-7](#) [CWD02-0](#) [CWD02-3](#) [CWD02-4](#) [CWD02-6](#) [CWD02-8](#) [CWD02-A](#) [CWD02-D](#)
[CWD02-H](#) [CWD02-K](#) [CWD02-L](#) [CWD02-M](#) [CWD02-P](#) [CWD02-Q](#) [CWD02-R](#) [CWD02-U](#) [CWD02-W](#) [CWD02-Y](#) [CWD03-+](#) [CWD03-0](#)
[CWD03-P](#) [CWD06-0](#) [CWD06-8](#) [CWD06-9](#) [CWD06-L](#) [CWD06-N](#) [CWD09-0](#) [CWD09-5](#) [CWD09-7](#) [6806810001](#) [D04690-000](#) [7-1768041-1](#)
[726631-1](#) [739253-000](#) [F24597-000](#) [750-1412](#)