

Drawing No.	Rev.	Page
LA6-5DSNWB-POE-W18	D	1 / 9

SPECIFICATIONS

Product Name: Signal Tower

Model: LA6-5DSNWB-POE

PATLITE Corporation

Drawing No.	Rev.	Page
LA6-5DSNWB-POE-W18	D	2 / 9

1. General Specifications

Model		LA6-5DSNWB-POE
Rated Voltage		24 VDC
Power Over Ethernet (PoE)		48 VDC
Operating Voltage Range		Rated Voltage $\pm 10\%$
Power Over Ethernet (PoE)		36 to 57 VDC
Rated Current Consumption	Typ.	0.30 A (24 VDC supply): 0.18 A (PoE: 48 VDC supply) *1
	Max.	0.49 A (26.4 VDC supply): 0.26 A (PoE: 48 VDC supply) *1
Rated Power Consumption	Typ.	7.2 W (24 VDC supply): 8.6 W (PoE: 48 VDC supply) *1
	Max.	12.9 W (26.4 VDC supply): 12.5 W (PoE: 48 VDC supply) *1
Signal Wire Current		420 mA *1 / 70 mA *2 (26.4 VDC supply): 10 mA (PoE: 48 VDC supply) *1
Operating Ambient Temperature		-10°C to +50°C
Operating Ambient Humidity		Less than 90% RH (No condensation)
Storage Ambient Temperature		-10°C to +50°C
Storage Ambient Humidity		Less than 90% RH (No condensation)
Mounting Location		Indoors
Mounting Direction		Upright
Protection Rating		IP20 (IEC 60529)
Environmental Condition		Upright
Vibration Resistance		Not Applicable
Insulation Resistance		More than 1 M Ω at 500 VDC between live part and non-current carrying metallic part.
Withstand Voltage		500 VAC applied for 1min between live part and non-current carrying metallic part without breaking insulation.
Mass (Tolerance $\pm 10\%$)		780 g
Outer Dimensions		Refer to the Outer Dimensions Drawing.
LED Tiers		5
Sound Pressure Level		85 dB or more
Environmental Condition		Maximum volume, Buzzer Sound No.1 measured from the front direction of the buzzer aperture at 1 m.
Interface	Power/Contact Input	Screwless Terminal Block (Number of Contacts : 12) Power: 2 (24 VDC), Contact Input (External relay/NPN/PNP): 8, Flashing/Pulse Enable: 1; COM: 1
	USB	USB micro-B Terminal USB 2.0
Communication Method		Ethernet (IEEE802.3 Conformity) 10BASE-T/100BASE-TX (Auto-MDI/MDIX)
LAN		RJ-45 Connector
PoE		Corresponds to IEEE802.3af Class 0 Conformity
Operation Interface		Multi-function Button (Located in Head Cover) Clear Switch
Indicator		1 (Green): Built in Clear Switch *Always on when Power is applied.
Accessory		Rubber Sheet
Optional Parts		Wallmount Bracket (NH-WST2)
Connectable LAN cable		Category 5e or higher (Both straight cable and cross cable types can be used)
Remarks		*1 Environmental Condition : Lighting all tiers Yellow, sounding Buzzer sound No.1 at maximum volume. *2 Environmental Condition : Only lighting tier 1 yellow with no sound.

Conformity Standards	RoHS Directive (EN IEC 63000) EMC Directive (EN 61000-6-4, EN 61000-6-2, EN55032 ClassA, EN55024) FCC Part 15 Subpart B Class A, ICES-003 Class A KC (KN 61000-6-4, KN 61000-6-2) UL 60950-1, CAN/CSA C22.2 No. UL60950-1-07 Recognized Component (File No.E480103)
Remarks	CE Marking Compliant

2. Model Number Configuration

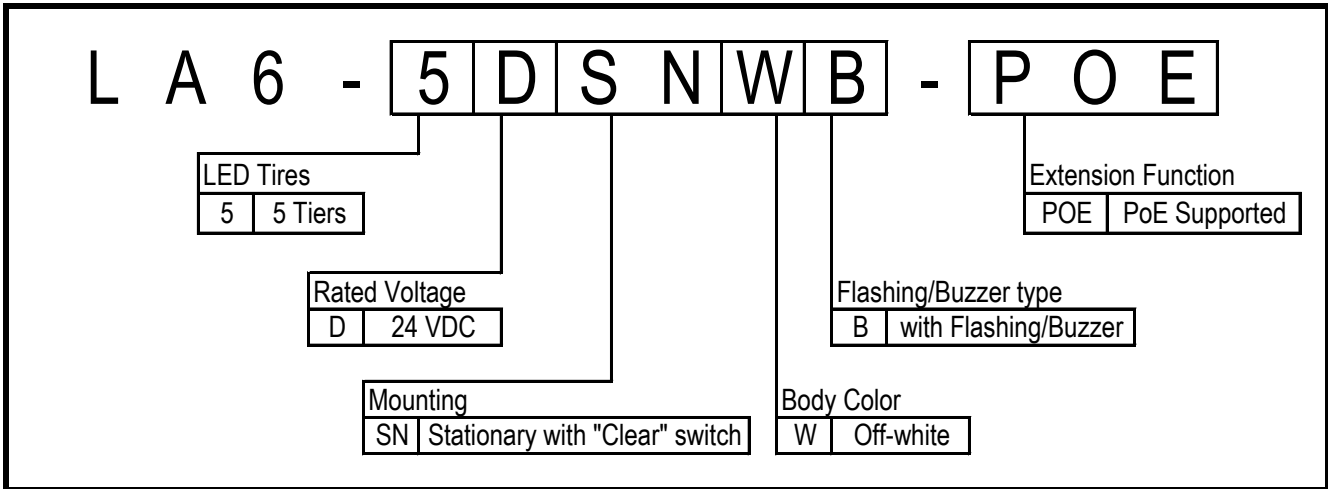

3. Wiring Diagram

3.1. Wiring Example

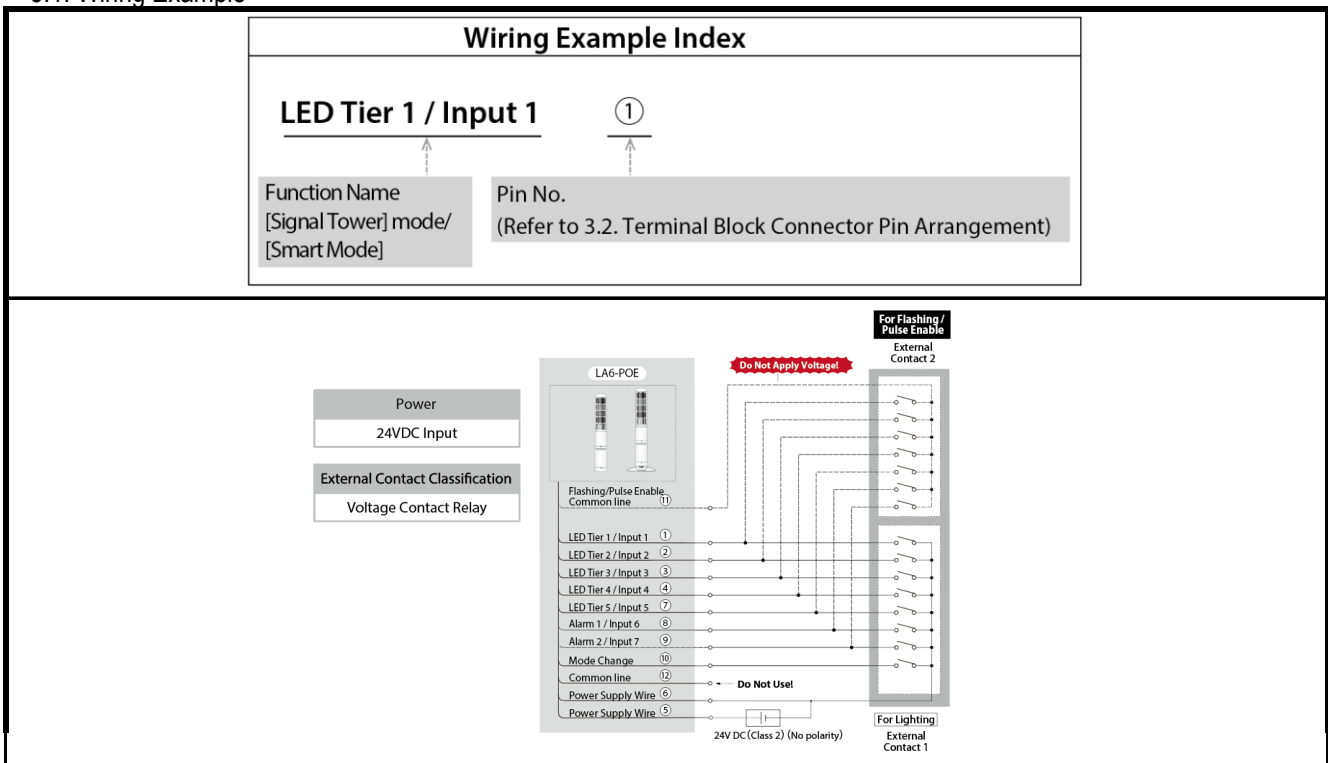

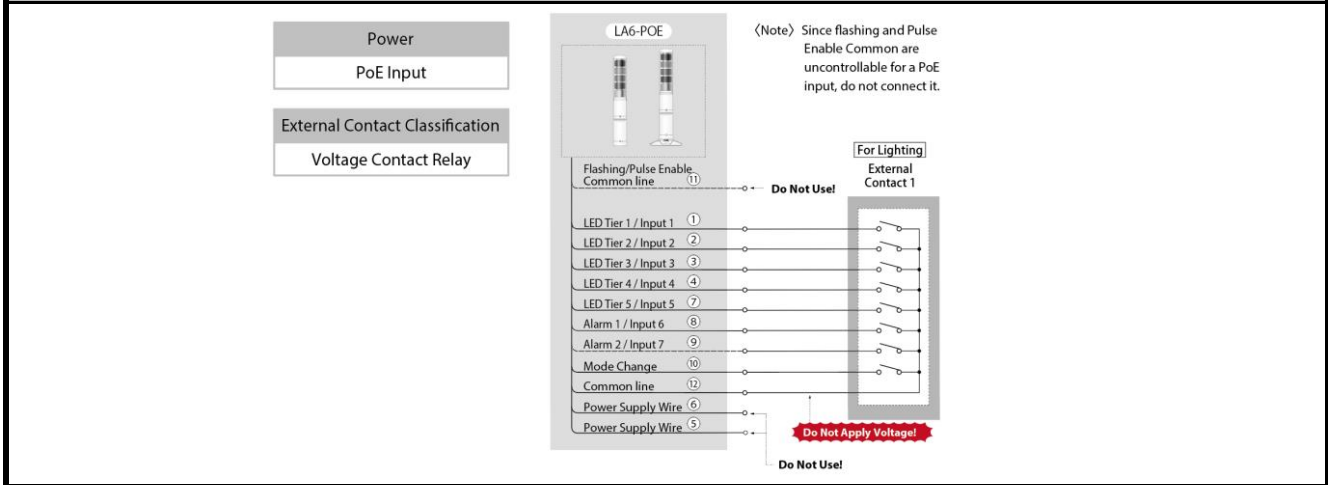
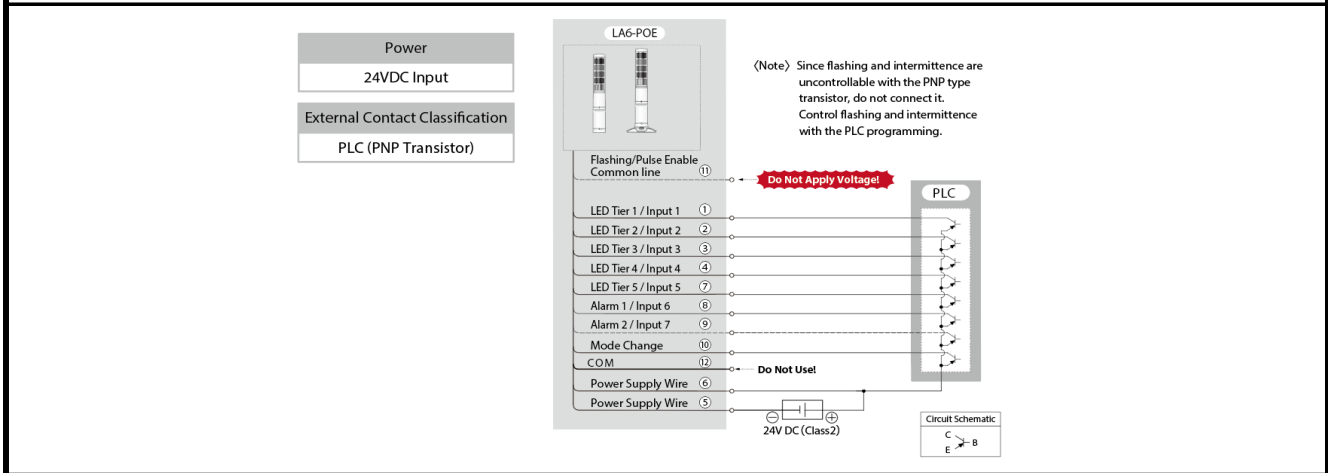
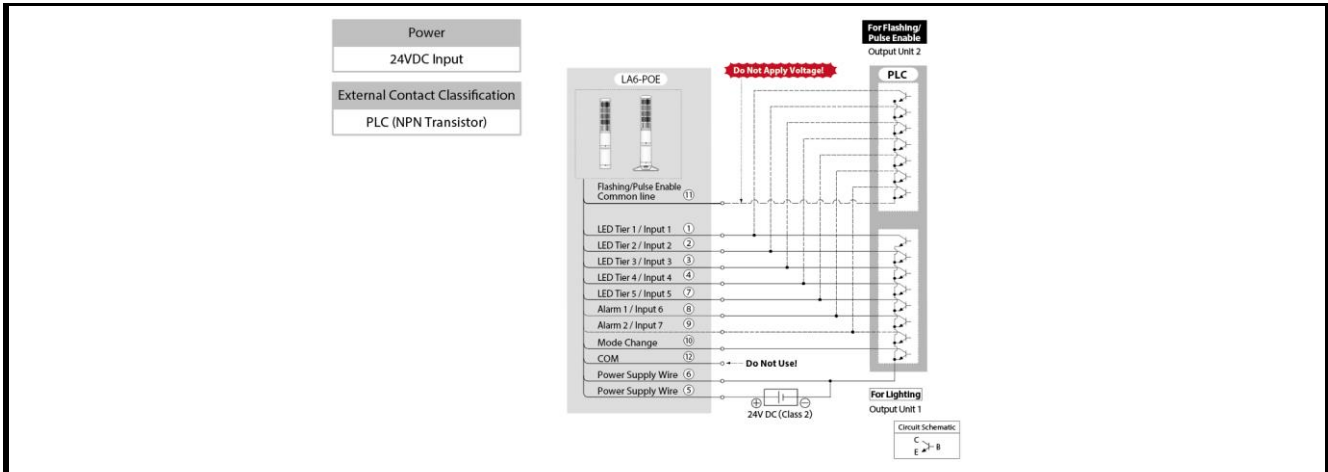

3.2. Terminal Block Connector Pin Arrangement

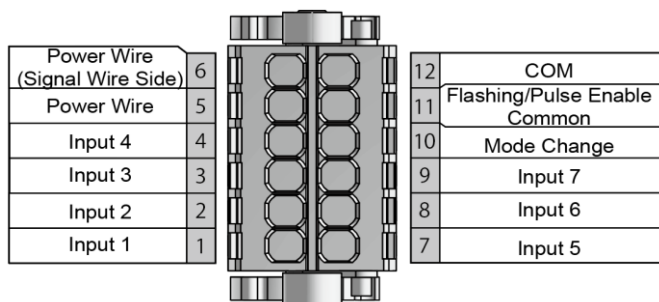

Recommended lead wire specifications

Wire Type	UL1007/UL1430
Wire Gauge (Solid Wire)	0.2-1.5 mm ²
Wire Gauge (Frayed Wire)	AWG24-16

Temperature rating should be above 75°C, and the conductor material should be of copper wire.

4. Operating Specifications

4.1. Notification Specifications

Signal Tower Mode	Signal Tower LED and buzzer can be controlled with registered color and sound.
LED Unit Control	Each tier can be controlled with Continuous Lighting, Flashing, Lights-off
Display Color Variations	9 Colors
Buzzer Sound	Select one from buzzer sounds No. 1, No. 2 and from No. 3 to No. 11
Smart Mode	Information such as "Takt time" and "Time count" can be notified.
Smart Mode types	"Single-display Type", "Time-trigger Type" and "Pulse-trigger Type"
Single-display Type	The registered pattern can be executed.
Time-trigger Type	The pattern transitions can be controlled in accordance to time.
Pulse-trigger Type	The pattern transitions can be controlled in accordance to a pulse-trigger input.
Display Color Variations	21 Colors
Buzzer Sound	11 Patterns
Detailed Command Control	Control by using commands to specify display color and buzzer pattern for each stage.
LED Control	Continuous Lighting, Flashing, Lights-off can be controlled for each Tier.
Display Color Variations	9 Colors
Buzzer Sound	11 Patterns

4.2. Signal Tower Specification

Flashing Rate	30±2 Flashes per Minute, 60±2 Flashes per Minute, 120±2 Flashes per Minute
Luminous Intensity (typ) *1	Red (1,000 mcd), Yellow (1,700 mcd), Green (2,600 mcd), Blue (1,000 mcd), White (1,250 mcd), Purple (800 mcd), Pink (850 mcd), Lemon yellow (2,150 mcd), Sky-blue (2,150 mcd)
Remarks	*1 Due to the characteristics of the LED elements, a variation in difference of the color tone and brightness of every product may occur.

4.3. Buzzer Specification

Buzzer Sound (Typical Frequency)	11 Patterns
No.1	2400 Hz Continuous beep sound
No.2	2400 Hz Rapid intermittent beep (0.05 sec. sound / 0.05 sec. silence)
No.3	2400 Hz Long intermittent beep (1.5 sec. sound / 1.5 sec. silence)
No.4	2400 Hz Fast intermittent beep (0.5 sec. sound / 0.5 sec. silence)
No.5	3600 Hz Continuous beep Sound
No.6	3600 Hz Rapid intermittent beep (0.05 sec. sound / 0.05 sec. silence)
No.7	3600 Hz Long intermittent beep (1.5 sec. sound / 1.5 sec. silence)
No.8	3600 Hz Fast intermittent beep (0.5 sec. sound / 0.5 sec. silence)
No.9	2400 Hz & 3375 Hz Multiplexed Beep (0.25 sec. / 0.25 sec.)
No.10	2400 Hz & 3600 Hz Multiplexed Beep (0.25 sec. / 0.25 sec.)
No.11	4000 Hz & 4800 Hz Multiplexed Beep (0.25 sec. / 0.25 sec.)

4.4 Contact Input Specifications

Mute	Silence the buzzer sound while the smart mode is executed.
STOP	Temporarily pause pattern transition while executing the Time-trigger in Smart Mode *1 Display a dedicated pattern while executing the Time-trigger in Smart Mode *1
Clear	Stop execution of the patterns in the Smart Mode and resume from the first pattern. *2 Turn off the Signal Tower and stop the Buzzer. *3
Pulse Trigger	Execute transition of patterns in Smart Mode.
Remarks	*1 Select any of them. *2 Executable only when controlling signal wires. *3 Executable only by controlling from commands.

5.Function Specification

5.1 Main Unit Control Function

Signal Wire Control	Controllable in the Signal Tower Mode or Smart Mode
Command Control	Select from Modbus/TCP, HTTP, Socket Communication.
Modbus/TCP	Controllable with Modbus/TCP.
HTTP Command	Controllable with HTTP Command.
Socket Communication	Controllable with PNS Command/PHN Command.
Contact Input	Mute, STOP, Clear, Pulse Trigger can be controlled.

Command	Controllable Action						
	Signal Tower Mode	Smart Mode	Detailed Command Control	Clear	Mute	STOP	Pulse Input
Signal Wire Control	✓ *1	✓	-	✓	✓	✓	✓
Modbus/TCP	✓	✓	✓	✓	✓	✓	✓
HTTP Command	✓	✓	✓	✓	✓	✓	✓
PNS Command	✓	✓	✓	✓	✓	✓	✓
PHN Command	✓ *2	-	-	-	-	-	-
Contact Input	-	-	-	✓	✓	✓	✓

*1 Can sound three buzzer patterns.

*2 Control Flashing and lighting for Tier 1 to Tier 3; Control Buzzer pattern sound No. 1 and No. 2.

5.2 Main Unit Status Acquisition Function

Modbus/TCP	Current status of Signal Tower, Buzzer, Contact Input can be acquired.
Socket Communication	Current status of Signal Tower, Buzzer, Contact Input by PNS Command/PHN Command can be acquired.
HTTP	Current status of Signal Tower, Buzzer, Contact Input and Firmware Version can be acquired by HTTP Command.

Command	Acquisition data						
	LED Unit	Buzzer	Smart Mode	Contact Input	Color Information	MAC Address	Firmware Version
Modbus/TCP	✓	✓	✓	✓	✓	-	-
PNS Command	✓	✓	✓	✓	✓ *3	✓	-
PHN Command	✓ *1	✓ *2	-	-	-	-	-
HTTP Command	✓	✓	✓	✓	✓	✓	✓ *4

*1 Tier 1 to Tier 3 Lighting, Flashing, Lights-off status can be acquired.

*2 Buzzer pattern No.1 and No.2 can be acquired.

*3 RGB color code can be acquired.

*4 LED Unit Firmware Version and LAN Unit Firmware Version can be acquired.

Drawing No.	Rev.	Page
LA6-5DSNWB-POE-W18	D	7 / 9

5.3 Status Transmission Function

Information Status	Transmit the present status of the Signal Tower from the controlled signal wire.								
Transmission Function									
Number of registrable destinations	1								
Communication method	Socket Communication								
<table border="1"> <thead> <tr> <th>Transmission data</th> <th>Details</th> </tr> </thead> <tbody> <tr> <td>Signal Tower status information</td> <td>Continuous Lighting, Flashing, Lights-off</td> </tr> <tr> <td>Smart Mode status information</td> <td>Group Number, Mute Input, STOP Input, Pattern Number</td> </tr> <tr> <td>Other information</td> <td>MAC address of this product, LED Unit color information, Last pattern received</td> </tr> </tbody> </table>		Transmission data	Details	Signal Tower status information	Continuous Lighting, Flashing, Lights-off	Smart Mode status information	Group Number, Mute Input, STOP Input, Pattern Number	Other information	MAC address of this product, LED Unit color information, Last pattern received
Transmission data	Details								
Signal Tower status information	Continuous Lighting, Flashing, Lights-off								
Smart Mode status information	Group Number, Mute Input, STOP Input, Pattern Number								
Other information	MAC address of this product, LED Unit color information, Last pattern received								

5.4 Link Function

Mirroring	Can transmit status data of a Master LA6-POE to other LA6-POE and control that same status.
Number of registrable destinations	8

5.5 Main Unit Setting Function

Automatic Network Setting	Network setting in this product can communicate with a DHCP server to be set automatically.
LED Color Setting	The LED color of the Signal Tower can be changed by the signal wire by setting it with the web browser or Multi-function Button.
Volume Control	The Buzzer Volume can be set with the web browser or Multi-function Button.
Clear Function	The "Clear" function can be controlled by the "Clear" Button on this product.
Main Unit Setting	Various settings to the Main Unit can be accessed by the web browser.
Configuration Setting	Various configurations of the Main Unit can be read and written as setting files.
Supported Setting Languages	Japanese, English
Supported Application	EDITOR for LA series LA6-POE Configurator software. *Visit our company's home page and download the latest application software for free.

Drawing No.	Rev.	Page
LA6-5DSNWB-POE-W18	D	8 / 9

[Handling Precaution]

◆ About the handling of this product

- This product (including software) is shipped only after undergoing strict quality controls and inspections. However, should you encounter any issues, please contact your PATLITE sales representative.
- This product (including software) is developed, designed and manufactured for general usage, such as office use, personal use, standard industry, and other related systems. Do not use, either directly or indirectly, in applications where a high level of safety is required, such as where human life is involved. We shall not be held liable for any damages or losses, nor be held responsible for any claims by a third party, as a result of using this product.
- The suitability of this product in the system, with other machines and equipment, shall be tested and confirmed by the customer. We assume no responsibility regarding this. Design safety into the system to cope with misoperation, misuse, going offline, and other unforeseen operation of this product.
- We bear no responsibility for damages, lost opportunities, lost profits, compensation for accidents, or other costs including but not limited to personnel, construction, transportation, and shipping costs, related to using this product. We bear no responsibility for defects in other products, regardless of the other product's connection to this product (such as a communication line), or for the cost of repairing damages, losses, defects, or recovering lost data related to using the other products, including but not limited to personnel, construction, transportation, and shipping costs.
- To improve the functionality in the software for this product, we will update the software at our own discretion. We bear no responsibility for the results of software updates, such as damages, lost opportunities, lost profits, compensation for accidents, or other costs including but not limited to personnel, construction, transportation, and shipping costs, related to using this product. We bear no responsibility for defects in other products, regardless of the other product's connection to this product (such as a communication line), or for the cost of repairing damages, losses, defects, or recovering lost data related to using other products, including but not limited to personnel, construction, transportation, and shipping costs.
- Note the following statements regarding the software for this product, which require prior written consent from PATLITE:
 - * Do not duplicate the software for this product.
 - * Do not alter, combine, reverse-engineer, decompile, or disassemble the software for this product.
 - * Do not license, rent, or resell the software for this product to a third party.
 - * Do not store the software of this product on a network so it can be transmitted to a third party.
 - * Do not remove the copyright notice or other trademark and company rights attached to the software for this product.

◆ Things you should always do for your safety

- Do not disassemble or modify the product. Failure to do so may lead to product malfunction or cause fire or electrocution.
- Avoid spilling liquids (such as water or chemicals) into this product. Avoid dropping foreign metallic objects (such as copper wire) into this product. Failure to follow these instructions could result in electric shock or equipment damage.
- Do not drop or hit this product. Failure to follow these instructions could result in electric shock or equipment damage.
- Do not pull strongly the cable to be connected, or use damaged cable. It becomes a disconnection or a short circuit, and this product or connected equipment may be broken or it may cause ignition.
- Do not apply too much force to switches and buttons on this product. Failure to follow this instruction could result in equipment damage.

◆ Installation

- Turn off the power when wiring, inspecting, or repairing this product. Failure to follow this instruction could result in equipment damage.
- Do not install in locations near fire, or environments with high temperature and humidity. Do not install this product where corrosive or flammable gas is present.
- Do not install on an unstable surface. Failure to follow these instructions could result in injury or equipment damage.
- This product is rated for indoor use only. Please install and use this product indoors only.
- Avoid the following locations for installation of this product.
 - * Places exposed to direct sunlight.
 - * Places near fire or environments with high temperatures and humidity.
 - * Environments where temperature changes are severe, and where there is condensation.
 - * Environments with poor breathability and ventilation.
 - * Places where external vibrations are directly transmitted to this product.
 - * Environments where corrosive gas is present.
 - * Locations exposed to salty sea air.
 - * Locations near strong magnetic fields.
 - * Environments where there is dust, iron powder, and so on.
 - * Environments where chemicals and oil mist are present.

◆ About maintenance

- Do not clean this product with volatile chemicals such as benzene or thinners, or with chemical wiping cloths as it could damage the product.
- Clean this product with a soft, dry cloth.
- If the dry cloth is unable to clean off any dirt and grime, wipe the product firmly with a slightly water-moistened cloth.

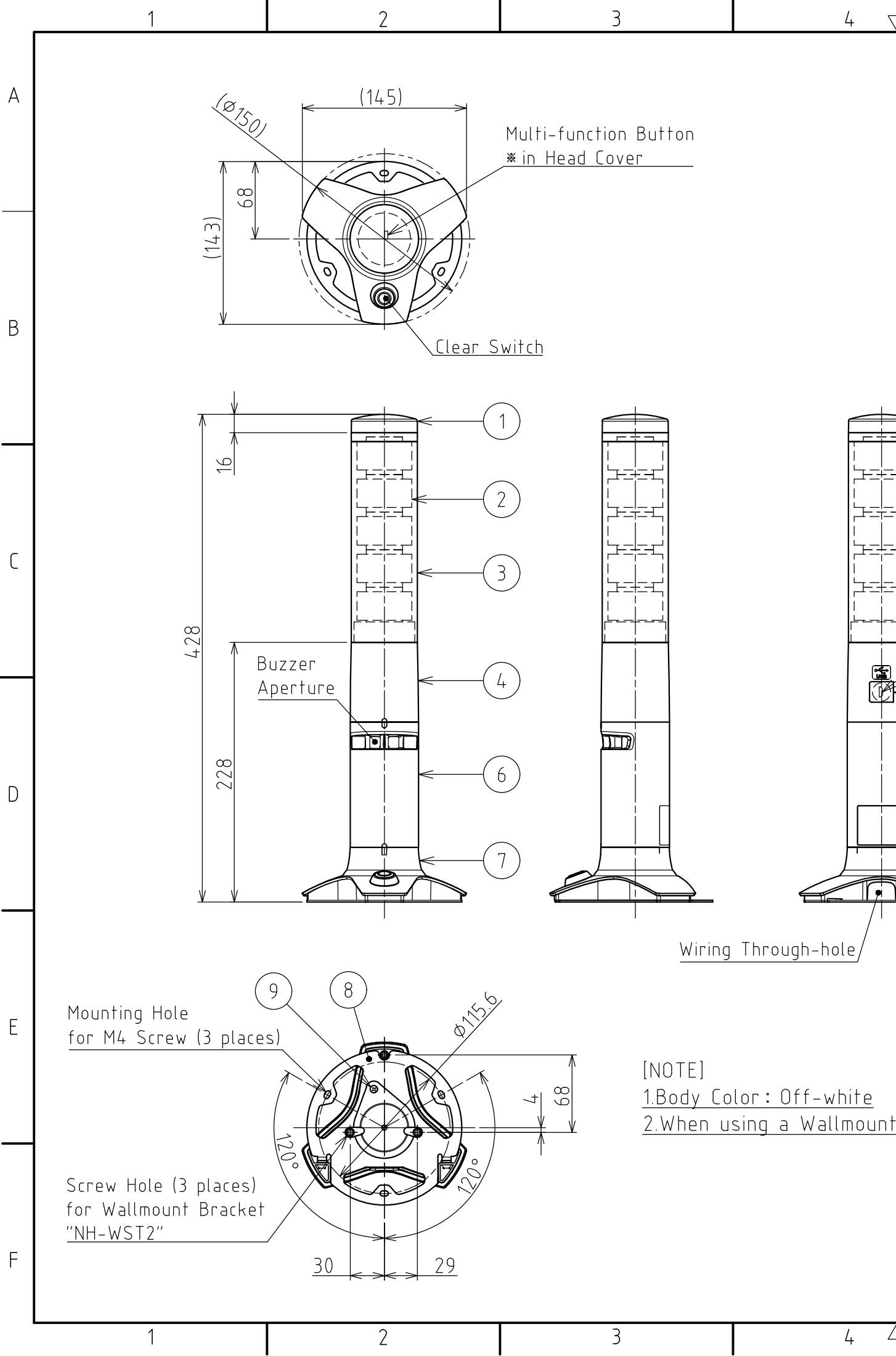

X-ON Electronics

Largest Supplier of Electrical and Electronic Components

Click to view similar products for [Patlite](#) manufacturer:

Other Similar products are found below :

[BDV-15JF-K](#) [BSV-24P-D](#) [BSV-24P-W](#) [CLA1S-24A-CD-30](#) [CLA2S-24A-CD-30](#) [CLA3S-24A-CD-30](#) [CLK3C-24AG-CD](#) [CLN-24A-CD-PT](#)
[CLN-24A-CD-T](#) [CWF-001](#) [CWF-002](#) [CWF3S-24-CD](#) [CWK2S-24-CD](#) [CWK3C-24-CD+FL008](#) [CWK3S-24-CD](#) [CWK6S-24-CD](#) [EHS-](#)
[M1TE](#) [EHV-M1TG](#) [LA6-3DTNUB-RYG](#) [LA6-3DTNUN-RYG](#) [LA6-3DTNWB-RYG](#) [LA6-5DTNUB-RYGBC](#) [LA6-5DTNUN-RYGBC](#)
[LA6-5DTNWB-RYGBC](#) [LFH-24-R](#) [LFH-24-Y](#) [LR4-02LJNU](#) [LR4-02LJNW](#) [LR4-02PJNU](#) [LR4-02QJNW](#) [LR4-02WJNU](#) [LR4-02WJNW](#)
[LR4-202LJBW-RG](#) [LR4-302LJBU-RYG](#) [LR4-302LJBW-RYG](#) [LR4-302LJNU-RYG](#) [LR4-302LJNW-RYG](#) [LR4-302QJBW-RYG](#) [LR4-](#)
[302QJNW-RYG](#) [LR4-302WJBU-RYG](#) [LR4-302WJBW-RYG](#) [LR4-302WJNU-RYG](#) [LR4-302WJNW-RYG](#) [LR4-402LJBW-RYGB](#) [LR4-BU](#)
[LR4-BW](#) [LR4-E-B](#) [LR4-E-C](#) [LR4-E-G](#) [LR4-E-R](#)