

Housing and distribution boards, distribution box

Housing, S-type

ABS

Housing

Norm: PN-EN 62208

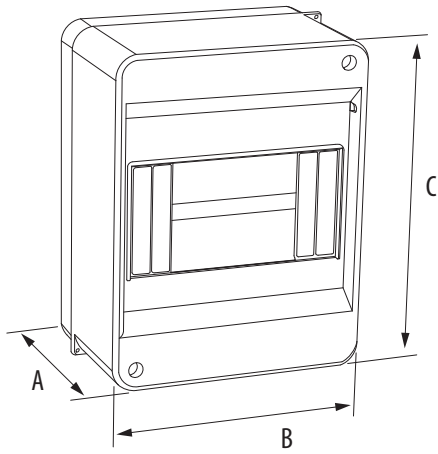

Housing S-2

IP40



C.2016

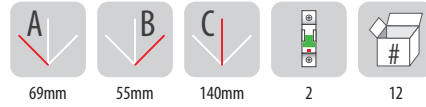

Remarks:

Housing S-3

IP40



C.2015

N+PE
C.2060

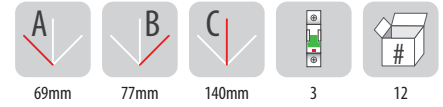

Remarks: S-3 C.2060 Housing with N+PE terminal strips inside

Housing S-4 Housing S-4

IP40



C.2014 N+PE
C.2062

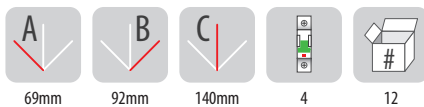

Remarks: S-4 C.2062 Housing with N+PE terminal strips inside

Housing S-5 Housing S-5

IP40



C.2064 N+PE
C.2065

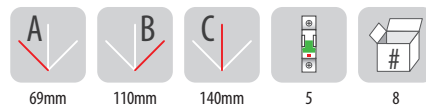

Remarks: S-5 C.2065 Housing with N+PE terminal strips inside

Housing S-6 Housing S-6

IP40



C.2066 N+PE
C.2021

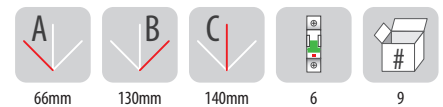

Remarks: S-6 C.2021 Housing with N+PE terminal strips inside

ABS

PC

Housing

Glass

Norm: PN-EN 62208

Housing S-type

Inside and back
S-6 N+PE



Housing S-2 with smoky glass

IP40



C.2030

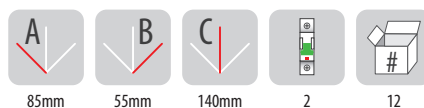

Remarks:

Housing S-3 with smoky glass

IP40



C.2019

N+PE
C.2061

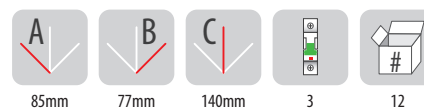

Remarks:
S-3 C.2061 Housing with N+PE terminal strips inside

Housing S-4 with smoky glass

IP40



C.2027

N+PE
C.2063

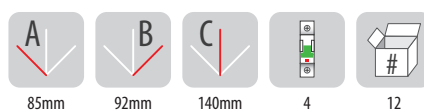

Remarks:
S-4 C.2063 Housing with N+PE terminal strips inside

Housing S-5 with smoky glass

IP40



C.2013

N+PE
C.2020

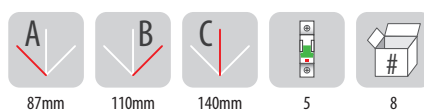

Remarks: Housing
S-5 C.2020 Housing with N+PE terminal strips inside

Housing S-6 with smoky glass

IP40



C.2067

N+PE
C.2031

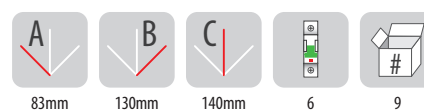

Remarks:
S-6 C.2031 Housing with N+PE terminal strips inside

Housing and distribution boards, distribution box

Housing, S-type

PC

Glass

ABS

Housing

Norm: PN-EN 62208

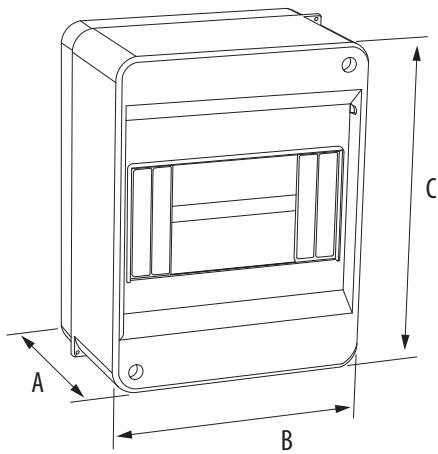

Housing S-8



C.2068
N+PE C.2017
IP40

A B C

66mm 165mm 140mm 8 6

Remarks: S-8 C.2017 Housing with N+PE terminal strips inside

Housing S-8 with smoky glass



C.2069
N+PE C.2025
IP40

A B C

83mm 165mm 140mm 8 6

Remarks: S-8 C.2025 Housing with N+PE terminal strips inside

Cover for housing S-12

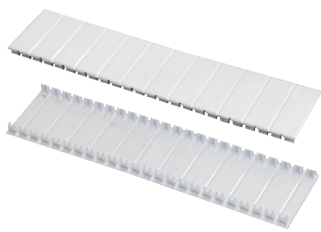

C.2080

A B C ABS

52mm 219mm 9,65mm 10

Remarks:

Housing S-12



C.2070
N+PE C.2071
IP40

A B C

80mm 240mm 140mm 12 1

Remarks: S-12 C.2071 Housing with N+PE terminal strips inside

Housing S-12 with smoky glass



C.2072
N+PE C.2073
IP40

A B C

96mm 240mm 140mm 12 1

Remarks: S-12 C.2073 Housing with N+PE terminal strips inside

RAL
7035

ABS

Facing wall distribution boards IP65

Norm: PN-EN 62208

Facing wall distribution boards



N+PE
C.14504

IP65

A 105mm B 145mm C 200mm

4 1

Remarks: Rated insulation voltage 1000V (AC/DC)

Facing wall distribution boards



N+PE
C.14508

IP65

A 105mm B 215mm C 200mm

8 1

Remarks: Rated insulation voltage 1000V (AC/DC)

Facing wall distribution boards



N+PE
C.14512

IP65

A 105mm B 290mm C 240mm

12 1

Remarks: Rated insulation voltage 1000V (AC/DC)

High quality surface mounted IP65 distribution boards

Facing wall distribution boards



N+PE
C.14524

IP65

A 140mm B 300mm C 400mm

24 1

Remarks: Rated insulation voltage 1000V (AC/DC)

Facing wall distribution boards



N+PE
C.14536

IP65

A 143mm B 430mm C 400mm

36 1

Remarks: Rated insulation voltage 1000V (AC/DC)



Housing and distribution boards, distribution box

Fully-equipped, ready to install universal distribution boards are available in five versions with metal door. Suitable for installation in masonry and plaster walls.

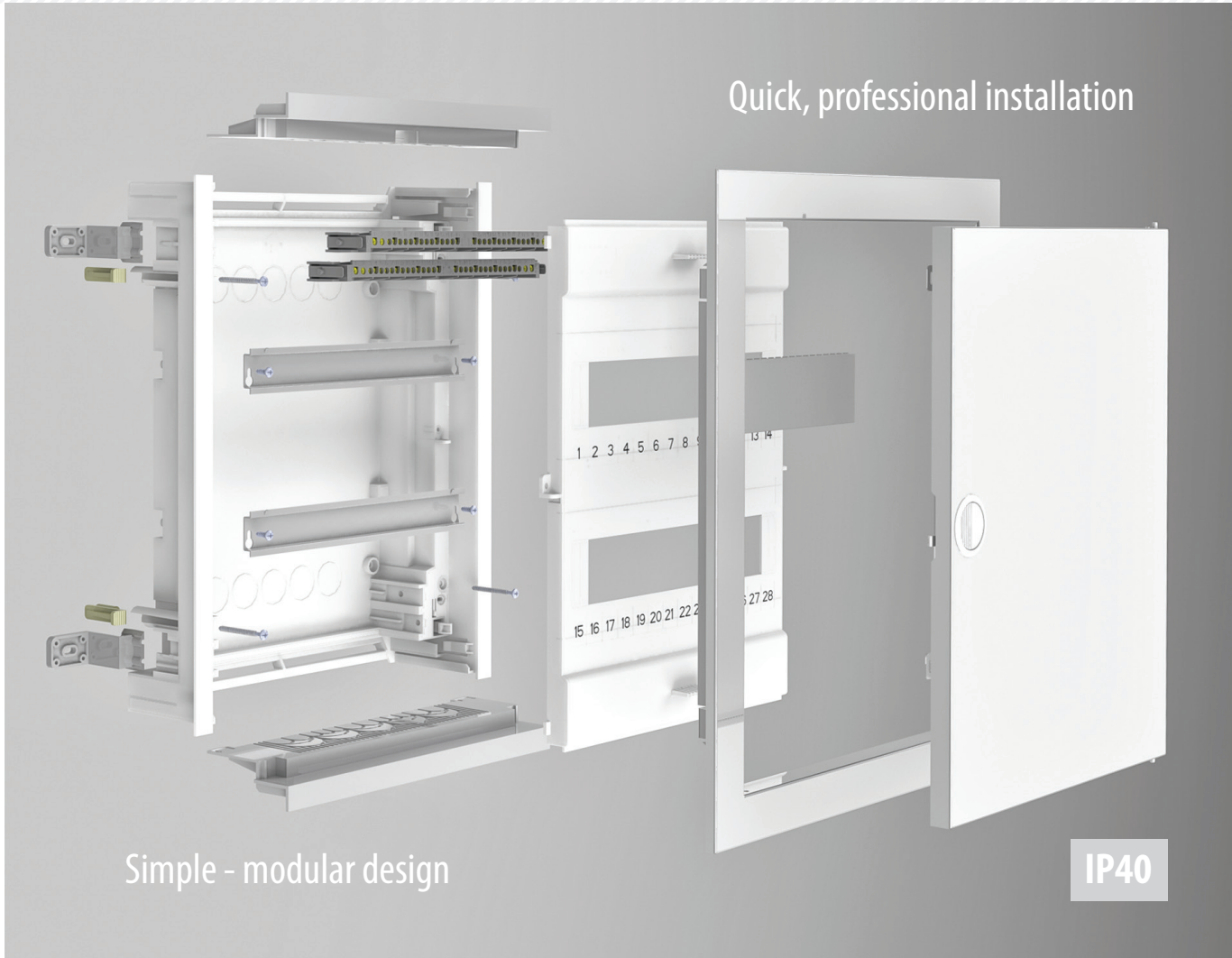

Large installation comfort due to smart design providing plenty of space inside the distribution board.



- 1 Universal mounting - to drywall or to ground
- 2 Possibility to control access for unauthorized persons (use of seals)
- 3 Many ways to bring the conduits to the distribution board
- 4 Easy assembly and disassembly of the N + PE conductor rail, click system
- 5 Can be used with locking key (optional)



RAL
9016

Norm: PN-EN 60439-3 In case of using key lock, amount of modules that can be used in a row adjacent to lock is reduced by 1

Universal distribution boards, n-row

Universal 1-row distribution board, Type: RO-1



Remarks: N+PE conductor rail 2x (2 x 25 mm² + 14 x 16 mm²) - 1 pcs

IT distribution board
Typ RO-2 with plastic doors



Remarks: Metal plate, perforated, 220x250mm, BETA1 socket

Dimensions

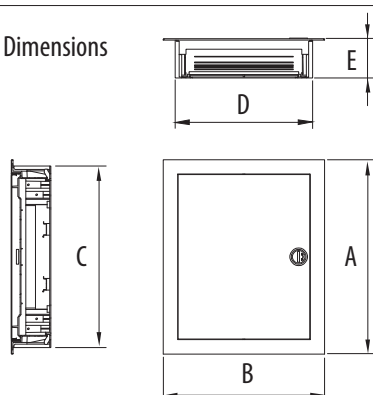

	A mm	B mm	C mm	D mm	E mm
C.1512	343	368	314	314	93
C.1524	443	368	414	314	93
C.1524-IT	443	368	414	314	95
C.1536	568	368	539	314	93
C.1548	753	368	724	314	93
C.1560	878	368	849	314	93

Universal 2-rows distribution board,
Type: RO-2



Remarks: N+PE conductor rail 2x (2 x 25 mm² + 14 x 16 mm²) - 1 pcs

Universal 3-rows distribution board,
Type: RO-1



Remarks: N+PE conductor rail 2x (2 x 25 mm² + 14 x 16 mm²) - 2 pcs

Additional parameters:

- » Protection class II
- » Rated voltage 400V
- » The stability of the operation from -15°C to +60°C

The content of universal distribution boards:

- » Carrying rails framework
- » N + PE conductor rail 2x (2 x 25 mm² + 14 x 16 mm²)
- » Metal door closed on the latch or lock
- » Mounting bracket TH 35

Universal 4-rows distribution board
Type: RO-4



Remarks: N+PE conductor rail 2x (2 x 25 mm² + 14 x 16 mm²) - 2 pcs

Universal 5-rows distribution board
Type: RO-5

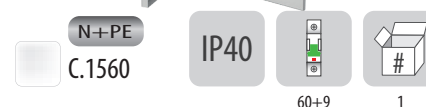

Remarks: N+PE conductor rail 2x (2 x 25 mm² + 14 x 16 mm²) - 2 pcs

Accessories:

C.2080
Cover for housing S-12



Housing and distribution boards, distribution box

Hermetic distribution cabinet - version with metal mounting plate, available with transparent and nontransparent door or in version with UV resistant nontransparent door.

IP65

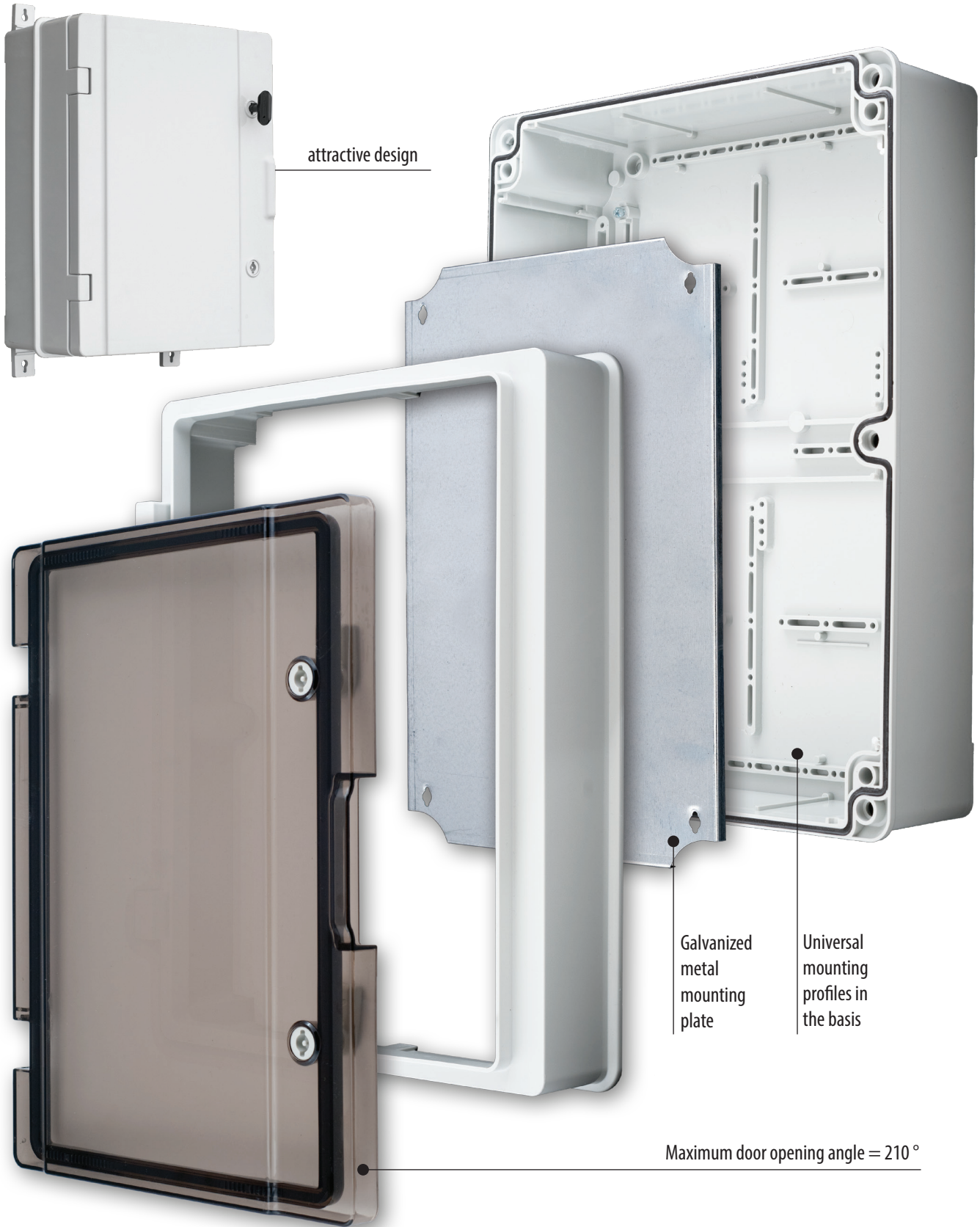

Housing and distribution boards, distribution box

A wide range of hermetic distribution cabinets. Durable! Practical! Spacious!
Hermetic distribution cabinets are available in five dimensional useful versions.

IP65



Distribution board catalogue no.			A [mm]	B [mm]	C [mm]	D [mm]	E [mm]
Nontransparent door	nontransparent UV resistant door	Transparent door					
C.1600	C.1600UV	C.1600-P	221	311	137	270	174.5
C.1601	C.1601UV	C.1601-P	265	355	152	315	227
C.1602	C.1602UV	C.1602-P	310	410	170	360	245
C.1602H	C.1602UVH		310	410	230	360	245
C.1603	C.1603UV	C.1603-P	410	610	202	564	375
C.1604	C.1604UV	C.1604-P	511	711	253,5	660	472

Note: Offered cabinets are available in a version with key and lock made of plastic

NEW - C.1602H and C.1602UVH version have bigger depth - 230 mm!

Additional parameters:

- Housing material: ABS
- Transparent door material: polycarbonate
- Impact resistance for the entire cabinet: IK 10
- UV resistance available as an option for nontransparent door version
- Operating temperature range: -25 ° to +60 °
- Polyurethane gasket



Example of control equipment and accessories installation

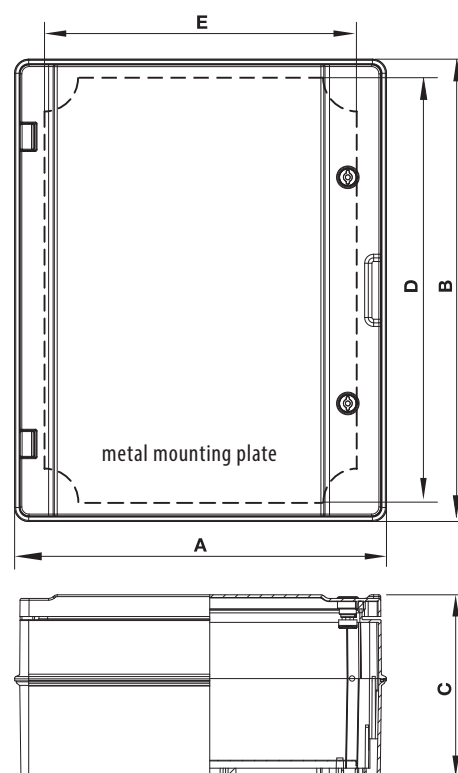

Facing wall, hermetic boxes

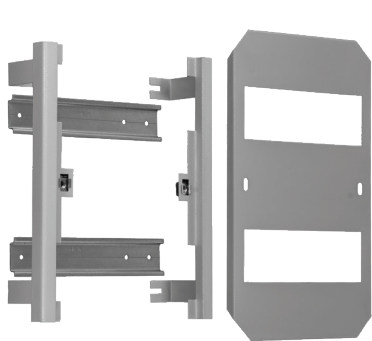

C.1600/PM

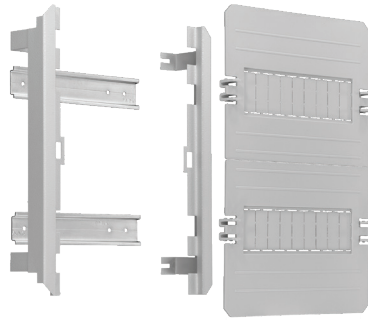

C.1601/PM

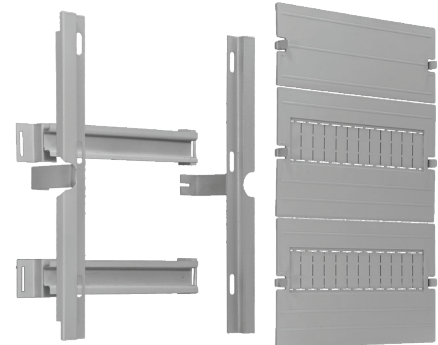

C.1602/PM

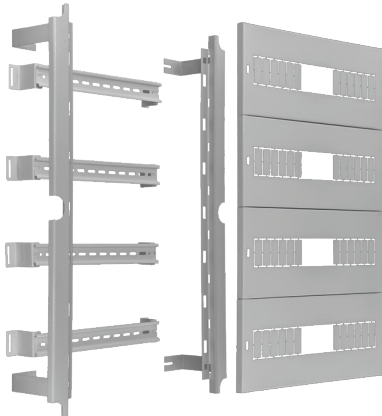

C.1603/PM

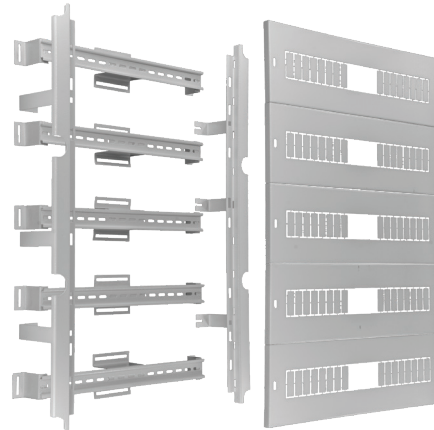

C.1604/PM



C.16-ZM

For the all IP 65 hermetic distribution cabinets offer we recommend the purchase of a metal lock – catalogue no. C.16-ZM

In our offer we have fixing packages for all offered distribution cabinets

fixing package catalogue no.	number of modules	fixing packages (masking fixing material - metal)	masking material	cabinet external dimensions [mm]	cabinet catalogue no.		
					nontransparent door	nontransparent UV resistant door	transparent door
C.1600/PM	2 x 8	fixing package for 210 IP 65 hermetic distribution cabinet	metal	221x311x137	C.1600	C.1600UV	C.1600-P
C.1601/PM	2 x 9	fixing package for 260 IP 65 hermetic distribution cabinet	metal	265x355x152	C.1601	C.1601UV	C.1601-P
C.1602/PM	3 x 10	fixing package for 300 IP 65 hermetic distribution cabinet	metal	310x410x170	C.1602	C.1602UV	C.1602-P
C.1603/PM	4 x 16	fixing package for 400 IP 65 hermetic distribution cabinet	metal	410x610x202	C.1603	C.1603UV	C.1603-P
C.1604/PM	5 x 20	fixing package for 500 IP 65 hermetic distribution cabinet	metal	511x711x254	C.1604	C.1604UV	C.1604-P

Housing and distribution boards, distribution box

3 popular models of hermetic distribution cabinets IP65 are available in many versions with built-in power equipment

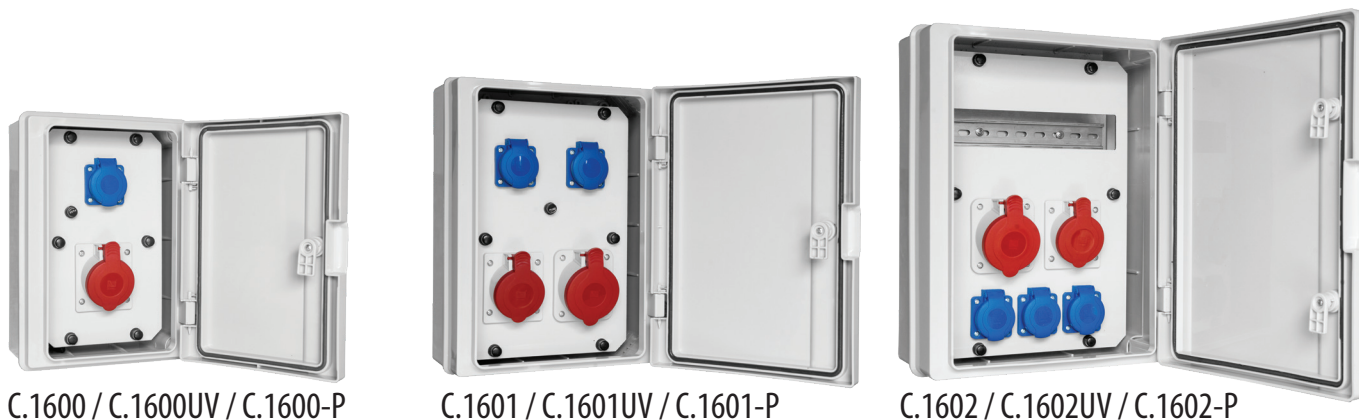

C.1600 / C.1600UV / C.1600-P

C.1601 / C.1601UV / C.1601-P

C.1602 / C.1602UV / C.1602-P

Exemplary configurations of series C.1600 / C.1600UV / C.1600-P



Exemplary configurations of series C.1601 / C.1601UV / C.1601-P

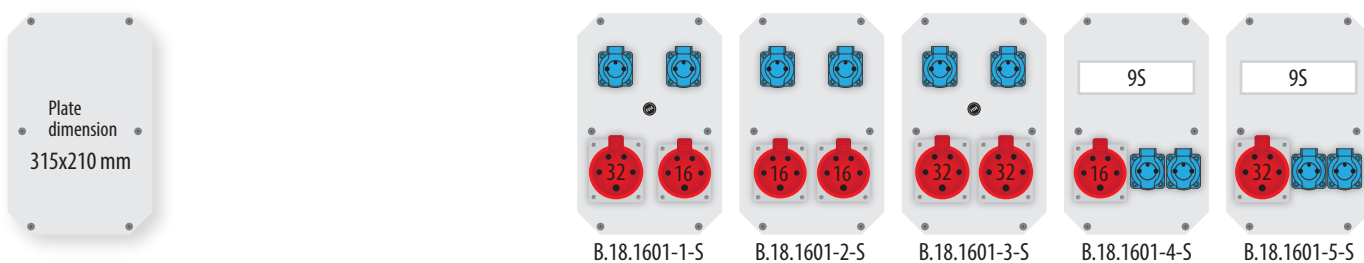

Exemplary configurations of series C.1602 / C.1602UV / C.1602-P

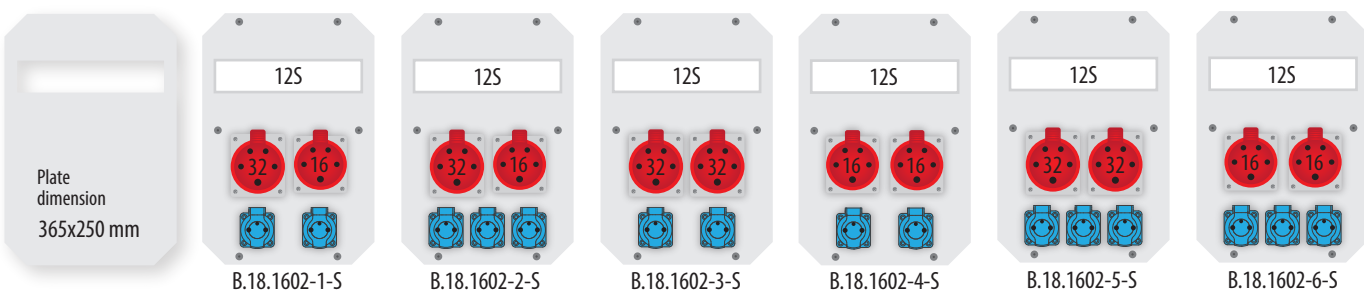

On the customer request, hermetic distribution cabinet IP 65 are available in all possible configurations, also in version with protection, including wire and plug

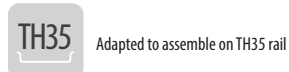
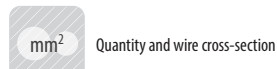
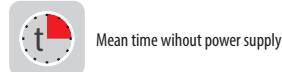
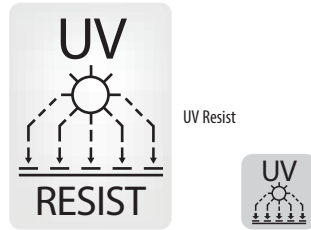
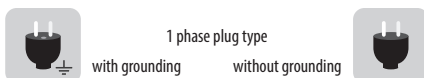
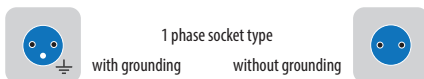
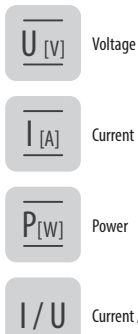
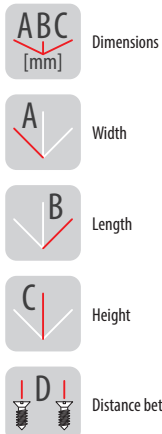
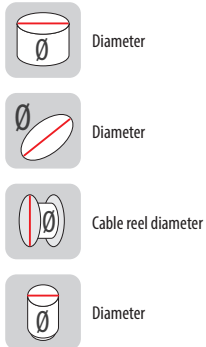

Voltage pictograms



Pictograms IP - ingress protection



Pictograms - wire type

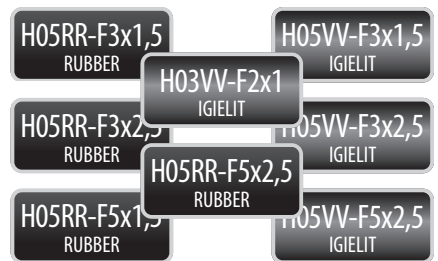

Pictograms - main colours of product



Pictograms - type of material

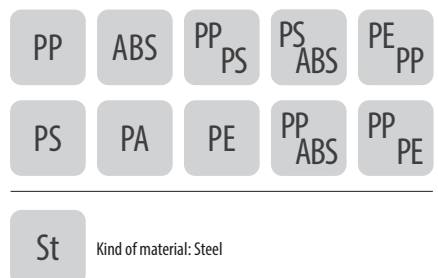

X-ON Electronics

Largest Supplier of Electrical and Electronic Components

Click to view similar products for [Latches](#) category:

Click to view products by [Pawbol](#) manufacturer:

Other Similar products are found below :

[ML4875CS-5](#) [401639B](#) [716165RB](#) [74F373DW](#) [74LVC373ADTR2G](#) [74LVC573ADTR2G](#) [NL17SG373DFT2G](#) [NLV14044BDG](#) [5962-8863901RA](#) [5962-88639012A](#) [NLV14042BDR2G](#) [GN 115-VDE-16](#) [74HC573D,653](#) [74AHC573PW,118](#) [2.L18.001-21](#) [2.PM18.002-18](#) [2.PM18.006-18](#) [2.T18.001-21](#) [2.T18.002-18](#) [2.T18.006-18](#) [CQ/AA-KEY](#) [CQ/A-M22X1,5-45-28](#) [CQ/A-M22X1,5-45-32](#) [M22-2-D5-2-21-01-P](#) [CY74FCT2373CTSOC](#) [421283](#) [MM74HC373WM](#) [MM74HC573WM](#) [74LCX373MTC](#) [74LVT16373MTDX](#) [74VHC373MX](#) [KLD5.001-02](#) [Z-0233-827-15](#) [MIC58P01YV](#) [74AHCT573D.112](#) [74LCX16373MTDX](#) [CQ/A-M22X1,5-45-16](#) [CQ/A-M22X1,5-45-18](#) [CQ/A-M22X1,5-45-20](#) [CQ/A-M22X1,5-45-24](#) [CQ/A-M22X1,5-45-30](#) [CQT/A-32-18 AE-V0](#) [CQT/A-32 20-AE-V0](#) [CY54FCT841ATDMB](#) [Z-2106-25001-22](#) [2.904.005](#) [2.904.006](#) [2.904.008](#) [2.KLB-D5.001PA-07](#) [2.KLB-T9.001PA-07](#)