

Features

- High power handling
 - 45 dBm @ 850 MHz, 32W
 - 44 dBm @ 2 GHz, 25W
- Exceptional linearity
 - 85 dBm IIP3 @ 850 MHz
 - 81 dBm IIP3 @ 2.7 GHz
- Low insertion loss
 - 0.25 dB @ 850 MHz
 - 0.40 dB @ 2 GHz
- Wide supply range of 2.3–5.5V
- +1.8V control logic compatible
- ESD performance
 - 1.5 kV HBM on all pins
- External negative supply option

Product Description

The PE42820 is a HaRP™ technology-enhanced high power reflective SPDT RF switch designed for use in mobile radio, relay replacement and other high performance wireless applications.

This switch is a pin-compatible upgraded version of the PE42510A with a wider frequency and power supply range, and external negative supply option. It maintains exceptional linearity and power handling from 30 MHz through 2.7 GHz. PE42820 also features low insertion loss, high power handling, and is offered in a 32-lead 5 × 5 mm QFN package. In addition, no external blocking capacitors are required if 0 VDC is present on the RF ports.

The PE42820 is manufactured on Psemi's UltraCMOS® process, a patented variation of silicon-on-insulator (SOI) technology on a sapphire substrate.

Psemi's HaRP technology enhancements deliver high linearity and excellent harmonics performance. It is an innovative feature of the UltraCMOS process, offering the performance of GaAs with the economy and integration of conventional CMOS.

Figure 2. Package Type
32-lead 5 × 5 mm QFN

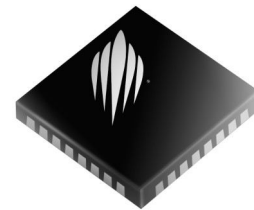

Figure 1. Functional Diagram

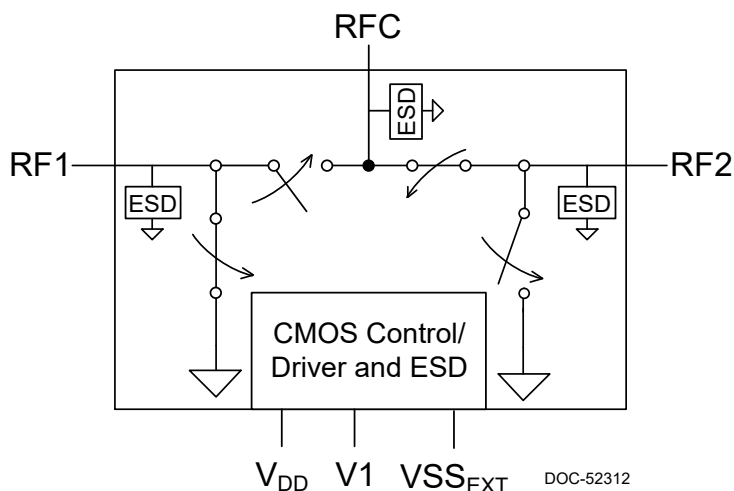

Table 1. Electrical Specifications @ +25 °C ($Z_S = Z_L = 50\Omega$), unless otherwise noted
Normal mode¹: $V_{DD} = 3.3V$, $V_{SS_EXT} = 0V$ or Bypass mode²: $V_{DD} = 3.3V$, $V_{SS_EXT} = -3.3V$

Parameter	Path	Condition	Min	Typ	Max	Unit
Insertion loss ³	RFC-RFX	30 MHz–1 GHz		0.30	0.45	dB
		1–2 GHz		0.40	0.60	dB
		2–2.7 GHz		0.70	0.95	dB
Isolation	RFX-RFX	30 MHz–1 GHz	34	35		dB
		1–2 GHz	27	28		dB
		2–2.7 GHz	23	24		dB
Unbiased isolation	RFC-RFX	V_{DD} , $V_1 = 0V$, +27 dBm		6		dB
Return loss ³	RFX	30 MHz–1 GHz		22		dB
		1–2 GHz		20		dB
		2–2.7 GHz		14		dB
Harmonics	RFC-RFX	2fo: +45 dBm pulsed @ 1GHz, 50 Ω		-94	-90	dBc
		3fo: +45 dBm pulsed @ 1GHz, 50 Ω		-84	-80	dBc
Input IP3	RFC-RFX	850 MHz		85		dBm
		2700 MHz		81		dBm
Input 0.1dB compression point ⁴	RFC-RFX	30 MHz–2 GHz		45.5		dBm
		2–2.7 GHz		44.5		dBm
Switching time		50% CTRL to 90% or 10% RF		15	25	μ s
Settling time		50% CTRL to harmonics within specifications ⁵		30	45	μ s

- Notes: 1. Normal mode: single external positive supply used.
2. Bypass mode: both external positive supply and external negative supply used.
3. Performance specified with external matching. Refer to *Evaluation Kit* section for additional information.
4. The input 0.1dB compression point is a linearity figure of merit. Refer to *Table 3* for the operating RF input power (50 Ω).
5. See harmonics specs above.

Figure 3. Pin Configuration (Top View)

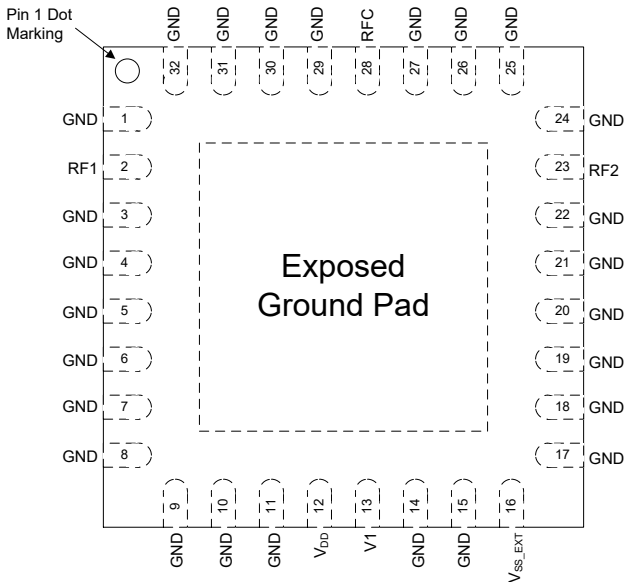

Table 2. Pin Descriptions

Pin #	Pin Name	Description
1, 3–11, 14, 15, 17–22, 24–27, 29–32	GND	Ground
2	RF1 ¹	RF port
12	V _{DD}	Supply voltage (nominal 3.3V)
13	V1	Digital control logic input 1
16	V _{SS_EXT} ²	External V _{SS} negative voltage control
23	RF2 ¹	RF port
28	RFC ¹	RF common
Pad	GND	Exposed pad: ground for proper operation

Notes: 1. RF pins 2, 23 and 28 must be at 0 VDC. The RF pins do not require DC blocking capacitors for proper operation if the 0 VDC requirement is met.
2. Use V_{SS_EXT} (pin 16, V_{SS_EXT} = -V_{DD}) to bypass and disable internal negative voltage generator. Connect V_{SS_EXT} (pin 16, V_{SS_EXT} = GND) to enable internal negative voltage generator.

Table 3. Operating Ranges

Parameter	Symbol	Min	Typ	Max	Unit
Normal mode ¹					
Supply voltage	V _{DD}	2.3		5.5	V
Supply current	I _{DD}		130	200	μA
Bypass mode ²					
Supply voltage	V _{DD}		3.3	5.5	V
Supply current	I _{DD}		50	80	μA
Negative supply voltage	V _{SS_EXT}	-3.6		-3.2	V
Negative supply current	I _{SS}	-40	-16		μA
Normal or Bypass mode					
Digital input high (V1)	V _{IH}	1.17		3.6 ³	V
Digital input low (V1)	V _{IL}	-0.3		0.6	V
RF input power, CW 30 MHz–2 GHz >2–2.7 GHz	P _{MAX,CW}			43 42	 dBm dBm
RF input power, pulsed ⁴ 30 MHz–2 GHz >2–2.7 GHz	P _{MAX,PULSED}			45 44	 dBm dBm
RF input power, unbiased	P _{MAX,UNB}			27	dBm
Operating temperature range (Case)	T _{OP}	-40		+85	°C
Operating junction temperature	T _J			+140	°C

Notes: 1. Normal mode: connect pin 16 to GND to enable internal negative voltage generator.
2. Bypass mode: apply a negative voltage to V_{SS_EXT} (pin 16) to bypass and disable internal negative voltage generator.
3. Maximum V_{IH} voltage is limited to V_{DD} and cannot exceed 3.6V.
4. Pulsed, 10% duty cycle of 4620 μs period, 50Ω.

Table 4. Absolute Maximum Ratings

Parameter/Condition	Symbol	Min	Max	Unit
Supply voltage	V_{DD}	-0.3	5.5	V
Digital input voltage (V1)	V_{CTRL}	-0.3	3.6	V
Maximum input power 30 MHz–2 GHz >2–2.7 GHz	$P_{MAX,ABS}$		45.5 44.5	dBm dBm
Storage temperature range	T_{ST}	-65	+150	°C
Maximum case temperature	T_{CASE}		+85	°C
Peak maximum junction temperature (10 seconds max)	T_J		+200	°C
ESD voltage HBM ¹ , all pins	V_{ESD}		1500	V
ESD Voltage MM ² , all pins	V_{ESD}		200	V

Notes: 1. Human Body Model (MIL-STD 883 Method 3015).
2. Machine Model (JEDEC JESD22-A115).

Exceeding absolute maximum ratings may cause permanent damage. Operation should be restricted to the limits in the Operating Ranges table. Operation between operating range maximum and absolute maximum for extended periods may reduce reliability.

Electrostatic Discharge (ESD) Precautions

When handling this UltraCMOS device, observe the same precautions that you would use with other ESD-sensitive devices. Although this device contains circuitry to protect it from damage due to ESD, precautions should be taken to avoid exceeding the rating specified.

Latch-Up Avoidance

Unlike conventional CMOS devices, UltraCMOS devices are immune to latch-up.

Moisture Sensitivity Level

The Moisture Sensitivity Level rating for the 32-lead 5 × 5 mm QFN package is MSL3.

Table 5. Control Logic Truth Table

Path	CTRL
RFC–RF1	H
RFC–RF2	L

Optional External V_{SS_EXT} Control (V_{SS_EXT})

For applications that require a faster switching rate or spur-free performance, this part can be operated in bypass mode. Bypass mode requires an external negative voltage in addition to an external V_{DD} supply voltage.

As specified in *Table 3*, the external negative voltage (V_{SS_EXT}) when applied to pin 16 will disable and bypass the internal negative voltage generator.

Switching Frequency

The PE42820 has a maximum 25 kHz switching rate in normal mode (pin 16 = GND). A faster switching rate is available in bypass mode (pin 16 = V_{SS_EXT}). The rate at which the PE42820 can be switched is then limited to the switching time as specified in *Table 1*.

Switching frequency describes the time duration between switching events. Switching time is the time duration between the point the control signal reaches 50% of the final value and the point the output signal reaches within 10% or 90% of its target value.

Spurious Performance

The typical low-frequency spurious performance of the PE42820 in normal mode is -137 dBm (pin 16 = GND). If spur-free performance is desired, the internal negative voltage generator can be disabled by applying a negative voltage to V_{SS_EXT} (pin 16).

Hot Switching Capability

The typical hot switching capability of the PE42820 is +30 dBm. Hot switching occurs when RF power is applied while switching between RF ports.

Typical Performance Data @ +25 °C, $V_{DD} = 3.3V$, $V_{SS_EXT} = 0V$, unless otherwise noted

Figure 4. Insertion Loss vs. Temp (RFC–RFX)

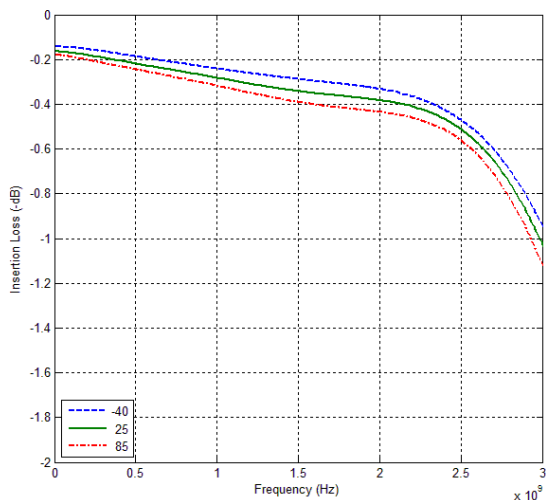

Figure 5. Insertion Loss vs. V_{DD} (RFC–RFX)

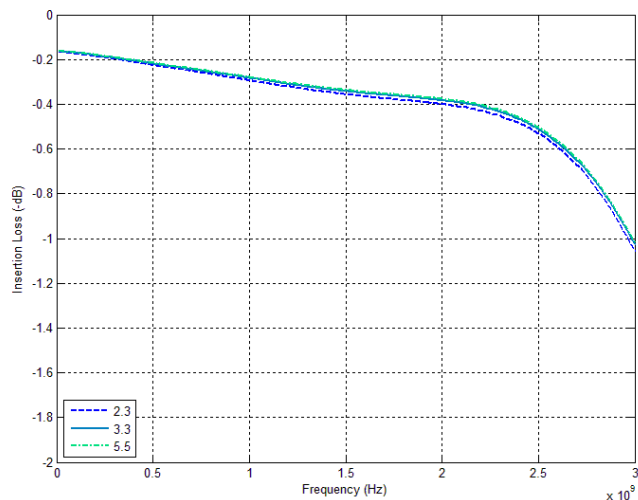

Figure 6. RFC Port Return Loss vs. Temp (RF1 Active)

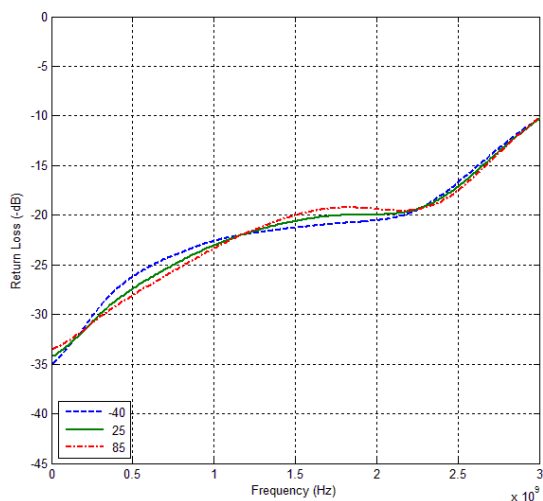
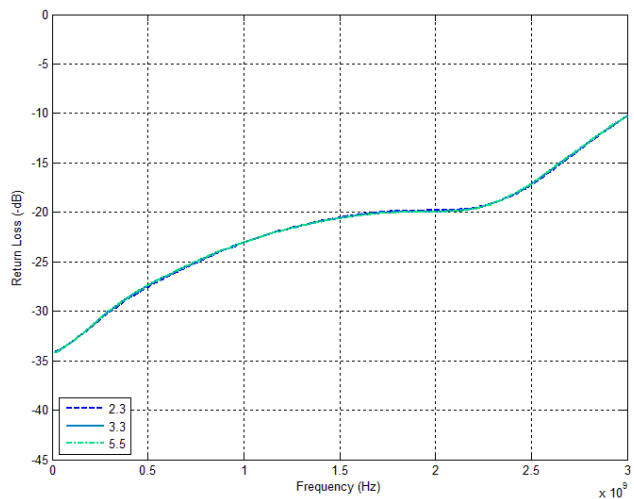

Figure 7. RFC Port Return Loss vs. V_{DD} (RF1 Active)



Typical Performance Data @ +25 °C, $V_{DD} = 3.3V$, $V_{SS_EXT} = 0V$, unless otherwise noted

Figure 8. Active Port Return Loss vs. Temp (RF1 Active)

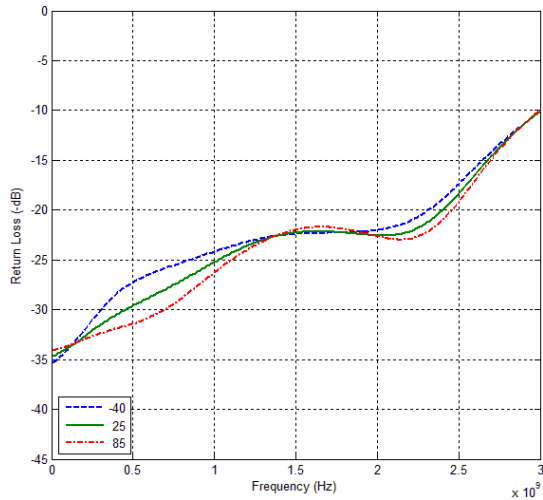

Figure 9. Active Port Return Loss vs. V_{DD} (RF1 Active)

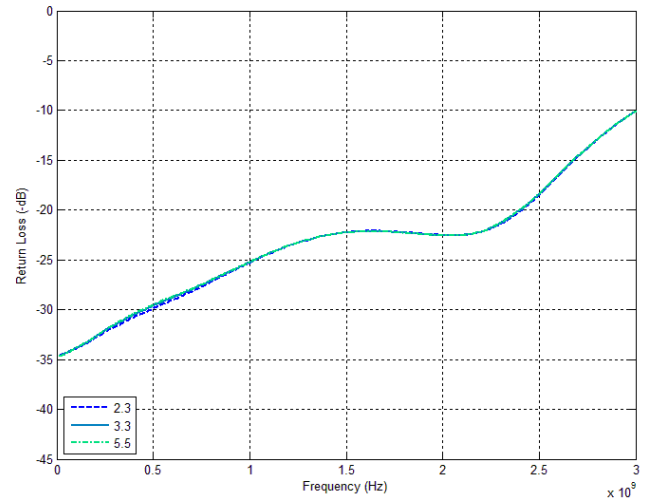

Figure 10. Isolation vs. Temp (RFC-RFX, RFX Active)

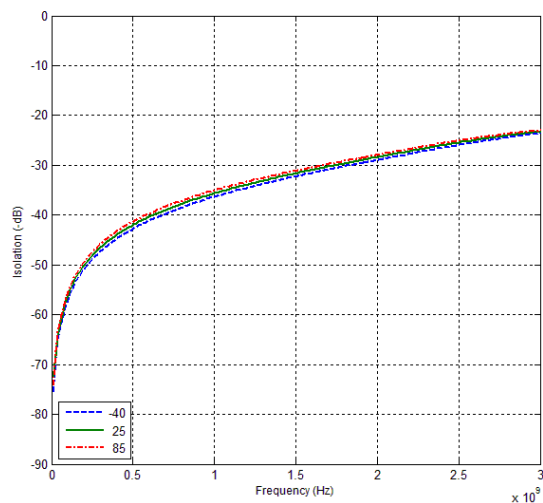
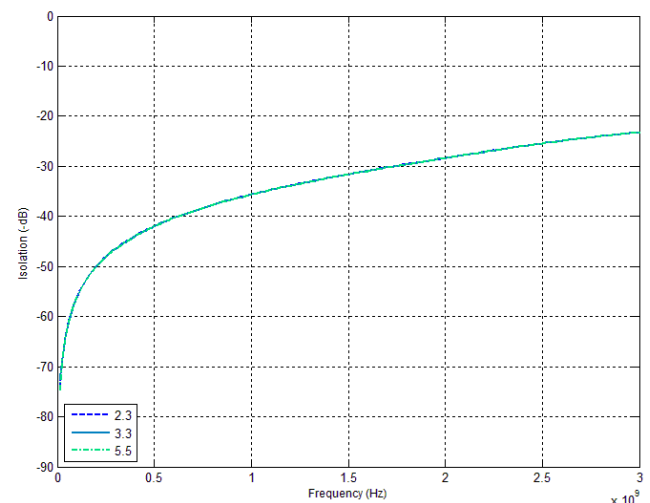

Figure 11. Isolation vs. V_{DD} (RFC-RFX, RFX Active)



Typical Performance Data @ +25 °C, $V_{DD} = 3.3V$, $V_{SS_EXT} = 0V$, unless otherwise noted

Figure 12. Isolation vs. Temp
(RFX-RFX, RFX Active)

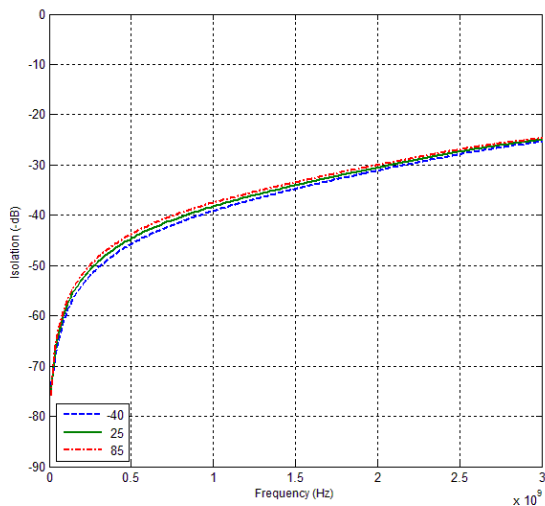
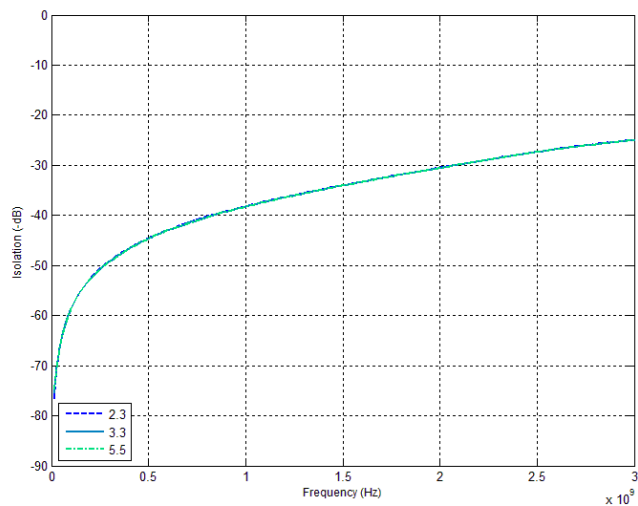

Figure 13. Isolation vs. V_{DD}
(RFX-RFX, RFX Active)



Thermal Data

Though the insertion loss for this part is very low, when handling high power RF signals, the junction temperature rises significantly.

VSWR conditions that present short circuit loads to the part can cause significantly more power dissipation than with proper matching.

Special consideration needs to be made in the design of the PCB to properly dissipate the heat away from the part and maintain the 85°C maximum case temperature. It is recommended to use best design practices for high power QFN packages: multi-layer PCBs with thermal vias in a thermal pad soldered to the slug of the package. Special care also needs to be made to alleviate solder voiding under the part.

Table 6. Theta JC

Parameter	Min	Typ	Max	Unit
Theta JC (+85 °C)		20		°C/W

Evaluation Kit

The PE42820 evaluation kit board was designed to ease customer evaluation of the PE42820 RF switch.

The evaluation board in *Figure 14* was designed to test the part. DC power is supplied through J10, with V_{DD} on pin 9, and GND on the entire lower row of even numbered pins. To evaluate a switch path, add or remove jumpers on V1 (pin 3) using *Table 5*.

The ANT port is connected through a 50Ω transmission line via the top SMA connector, J1. RF1 and RF2 paths are also connected through 50Ω transmission lines via SMA connectors as J2 and J3. A 50Ω through transmission line is available via SMA connectors J5 and J6. This transmission line can be used to estimate the loss of the PCB over the environmental conditions being evaluated. An open-ended 50Ω transmission line is also provided at J4 for calibration if needed.

Narrow trace widths are used near each part to improve impedance matching. The shunt C1 on RFC port is to provide for high frequency impedance matching.

Figure 14. Evaluation Board Layout

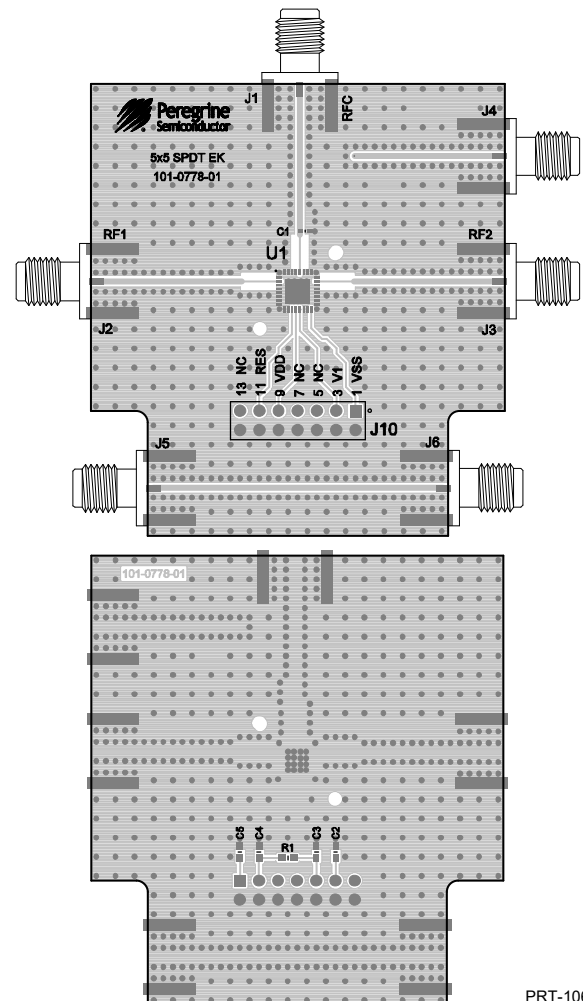

PRT-10605

Figure 15. Evaluation Board Schematic

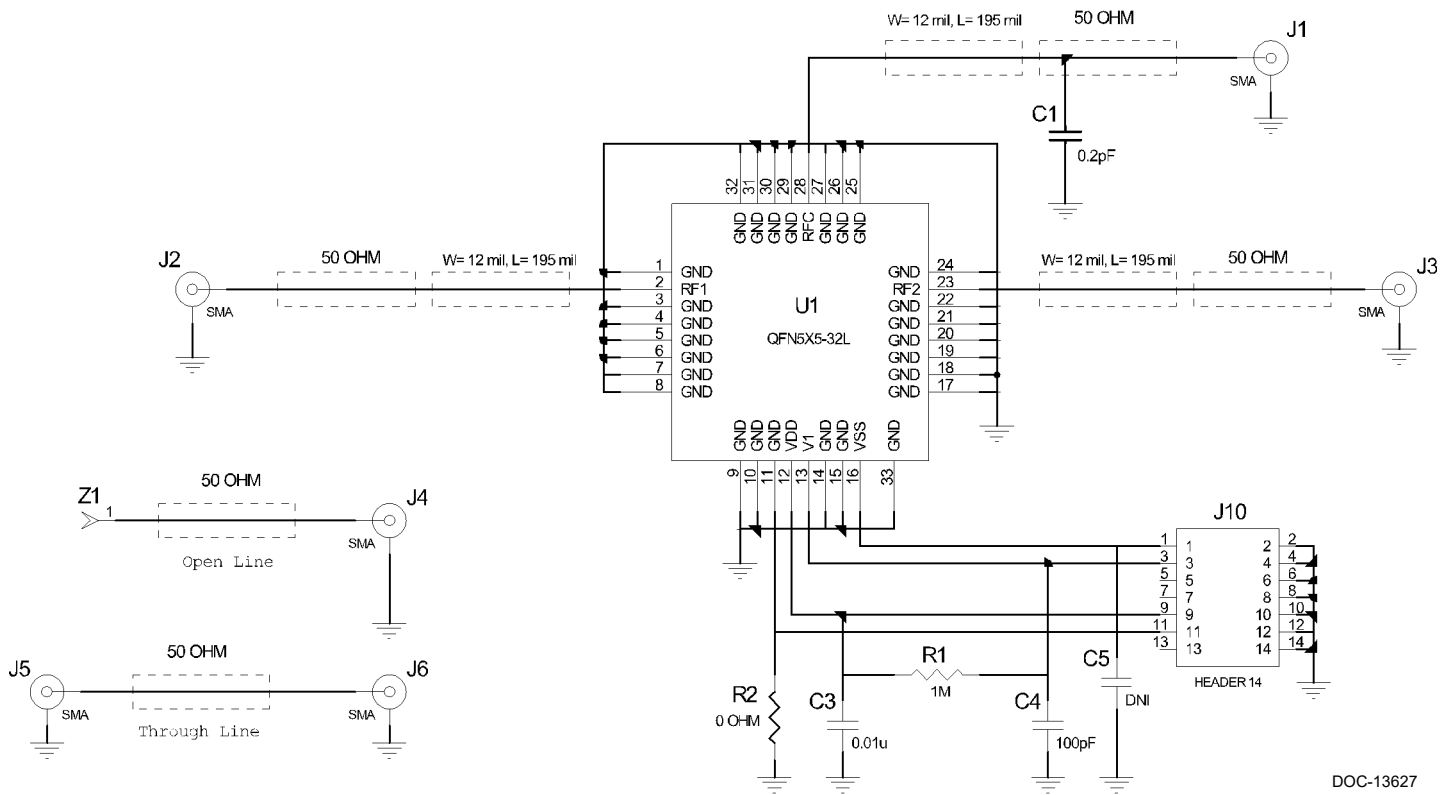

DOC-13627

Figure 16. Package Drawing
32-lead 5 × 5 mm QFN

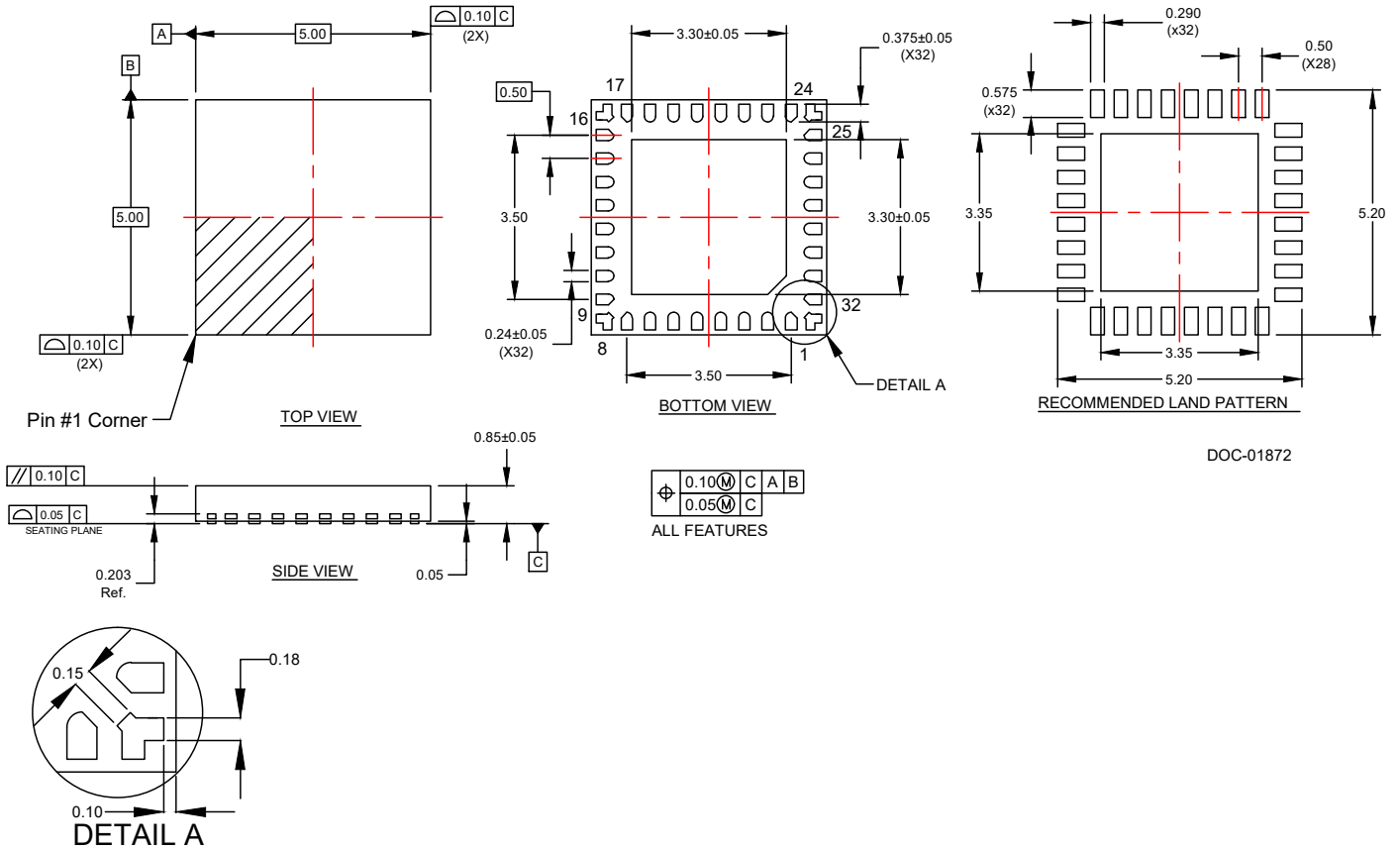
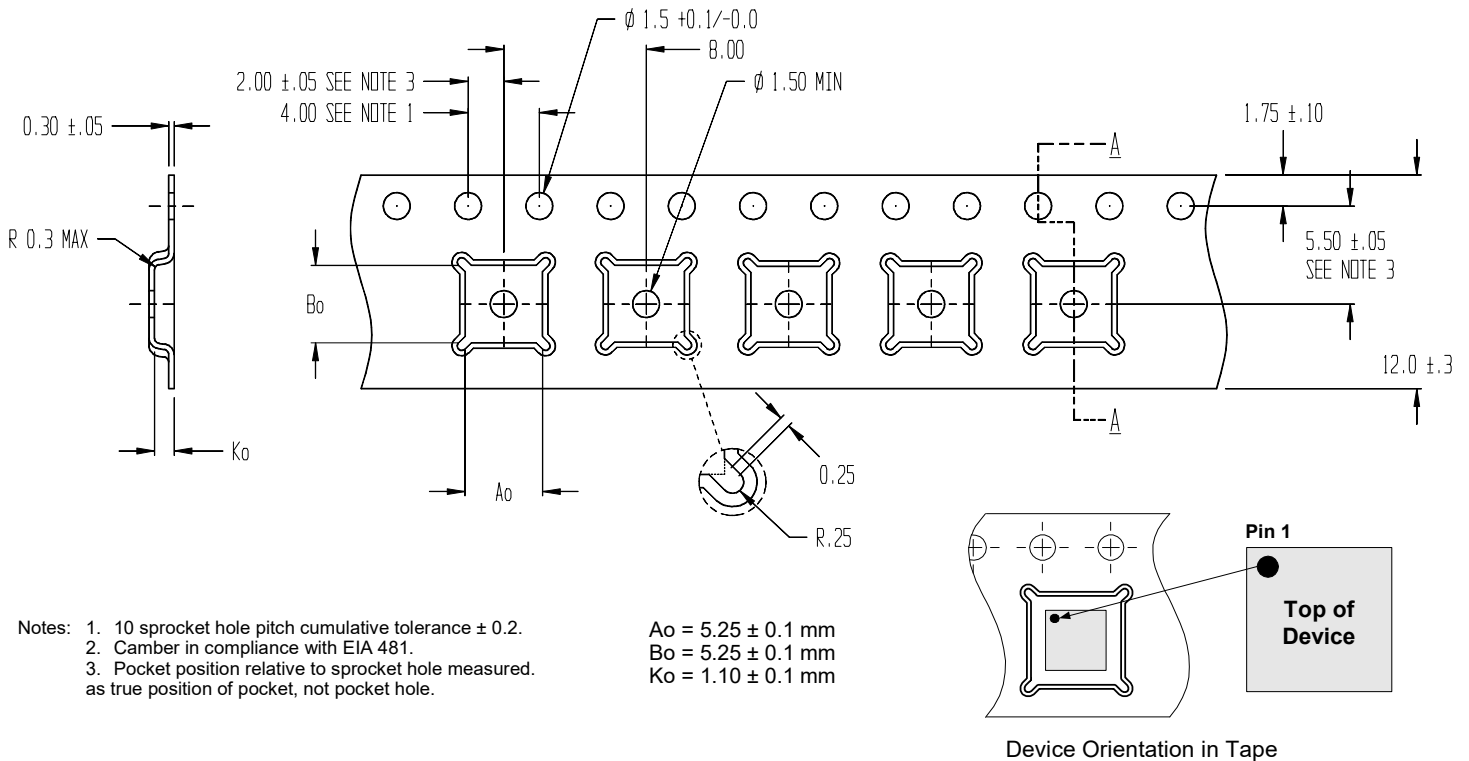

Figure 17. Top Marking Specification



● = Pin 1 indicator
YYWW = Date code, last two digits of the year and work week
ZZZZZZ = Six digits of the lot number

17-0085

Figure 18. Tape and Reel Specs

Table 7. Ordering Information

Order Code	Description	Package	Shipping Method
PE42820B-X	PE42820 SPDT RF switch	Green 32-lead 5 × 5 mm QFN	500 units/T&R
EK42820-03	PE42820 Evaluation kit	Evaluation kit	1/Box

Sales Contact and Information

For sales and contact information please visit www.psemi.com.

Advance Information: The product is in a formative or design stage. The datasheet contains design target specifications for product development. Specifications and features may change in any manner without notice. **Preliminary Specification:** The datasheet contains preliminary data. Additional data may be added at a later date. pSemi reserves the right to change specifications at any time without notice in order to supply the best possible product. **Product Specification:** The datasheet contains final data. In the event pSemi decides to change the specifications, pSemi will notify customers of the intended changes by issuing a CNF (Customer Notification Form). The information in this document is believed to be reliable. However, pSemi assumes no liability for the use of this information. Use shall be entirely at the user's own risk.

No patent rights or licenses to any circuits described in this document are implied or granted to any third party. pSemi's products are not designed or intended for use in devices or systems intended for surgical implant, or in other applications intended to support or sustain life, or in any application in which the failure of the pSemi product could create a situation in which personal injury or death might occur. pSemi assumes no liability for damages, including consequential or incidental damages, arising out of the use of its products in such applications. The Peregrine Semiconductor name, Peregrine Semiconductor logo and UltraCMOS are registered trademarks and the pSemi name, pSemi logo, HaRP and DuNE are trademarks of pSemi Corporation in the U.S. and other countries. pSemi products are protected under one or more of the following U.S. patents: patents.psemi.com.

X-ON Electronics

Largest Supplier of Electrical and Electronic Components

Click to view similar products for [psemi manufacturer](#):

Other Similar products are found below :

[EK42430-01](#) [EK42522-02](#) [EK4259-01](#) [EK42822-01](#) [EK43205-01](#) [EK43712-02](#) [EK64907-11](#) [EK64909-11](#) [EK64904-12](#) [EK45140-02](#)
[EK42820-02](#) [PE42582A-X](#) [PE42524A](#) [PE42820B](#) [PE42823A](#) [PE42542B](#) [PE42512A](#) [PE42020A](#) [PE42522B](#) [EK43205-02](#) [EK64904-13](#)
[PE426482A-X](#) [EK42542-03](#) [EK42442-01](#) [EK43705-11](#) [EK42721-02](#) [EK42641-04](#) [EK42422-01](#) [EK4256-01](#) [EK4250-01](#) [EK42451-01](#)
[EK4314-02](#) [EK64102-12](#) [EK43712-03](#) [EK42520-03](#) [EK42521-03](#) [EK423422-01](#) [EK42424-01](#) [EK46120-02](#) [EK42742-03](#) [EK42421-01](#)
[EK42359-01](#) [EK42723-01](#) [EK42522-03](#) [4270-00](#) [EK42420-04](#) [4257-00](#) [EK43704-12](#) [EK42426-01](#) [EK46140-01](#)