

### Product Description

The PE64101 is a DuNE™-enhanced Digitally Tunable Capacitor (DTC) based on Peregrine's UltraCMOS® technology. DTC products provide a monolithically integrated impedance tuning solution for demanding RF applications. They also offer a cost-effective tunable capacitor with excellent linearity and ESD performance.

This highly versatile product can be mounted in series or shunt configuration and is controlled by a 3-wire (SPI compatible) serial interface. High ESD rating of 2 kV HBM on all ports making this the ultimate in integration and ruggedness. The DTC is offered in a standard 12-lead 2.0 x 2.0 x 0.55 mm QFN package.

Peregrine's DuNE™ technology enhancements deliver high linearity and exceptional harmonics performance. It is an innovative feature of the UltraCMOS® process, providing performance superior to GaAs with the economy and integration of conventional CMOS.

**Figure 1. Functional Block Diagram**

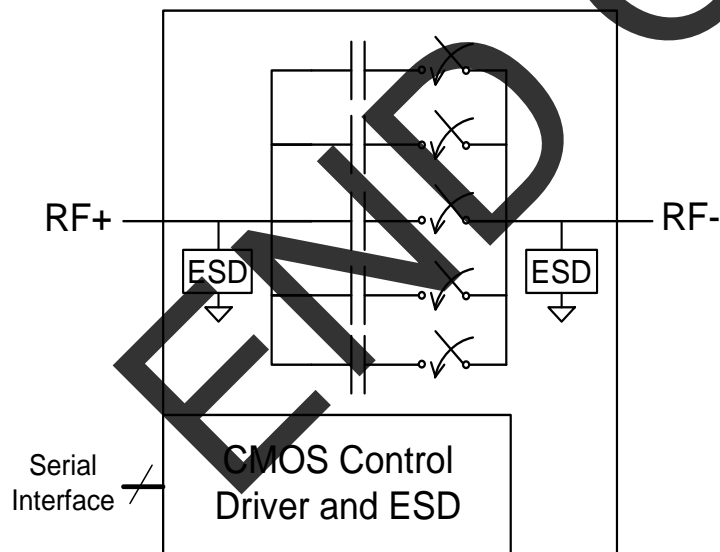

71-0066-01

### Features

- 3-wire (SPI compatible) 8-bit serial interface with built-in bias voltage generation and stand-by mode for reduced power consumption
- DuNE™-enhanced UltraCMOS® device
- 5-bit 32-state Digitally Tunable Capacitor
- $C = 1.38 - 5.90$  pF (4.3:1 tuning ratio) in discrete 146 fF steps
- RF power handling (up to 26 dBm, 6 V<sub>PK</sub> RF) and high linearity
- High quality factor
- Wide power supply range (2.3 to 3.6V) and low current consumption (typ. I<sub>DD</sub> = 30 μA @ 2.8V)
- Optimized for shunt configuration, but can also be used in series configuration
- Excellent 2 kV HBM ESD tolerance on all pins
- Applications include:
  - Antenna tuning
  - Tunable filters
  - Phase shifters
  - Impedance matching

**Figure 2. Package Type**

12-lead 2 x 2 x 0.55 mm QFN

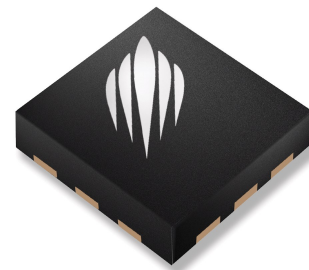

**Table 1. Electrical Specifications @ 25°C, V<sub>DD</sub> = 2.8V**

Parameter	Configuration	Condition	Min	Typ	Max	Units
Operating Frequency Range <sup>7</sup>	Both		100		3000	MHz
Minimum Capacitance	Shunt <sup>6</sup>	State = 00000, 100 MHz (RF+ to Grounded RF-)	-10%	1.38	+10%	pF
Maximum Capacitance	Shunt <sup>6</sup>	State = 11111, 100 MHz (RF+ to Grounded RF-)	-10%	5.90	+10%	pF
Tuning Ratio	Shunt <sup>6</sup>	C <sub>max</sub> /C <sub>min</sub> , 100 MHz		4.3:1		
Step Size	Shunt <sup>6</sup>	5 bits (32 states), constant step size (100 MHz)		0.146		pF
Quality Factor (C <sub>min</sub> ) <sup>1</sup>	Shunt <sup>6</sup>	470 - 582 MHz with L <sub>s</sub> removed 698 - 960 MHz, with L <sub>s</sub> removed 1710 - 2170 MHz, with L <sub>s</sub> removed		50 50 30		
Quality Factor (C <sub>max</sub> ) <sup>1</sup>	Shunt <sup>6</sup>	470 - 582 MHz with L <sub>s</sub> removed 698 - 960 MHz, with L <sub>s</sub> removed 1710 - 2170 MHz, with L <sub>s</sub> removed		50 25 10		
Self Resonant Frequency	Shunt <sup>7</sup>	State 00000 State 11111		5.5 2.5		GHz
Harmonics (2 <sub>fo</sub> and 3 <sub>fo</sub> ) <sup>4</sup>	Shunt <sup>6</sup>	470 to 582 MHz, Pin +26 dBm, 50Ω 698 to 915 MHz, Pin +26 dBm, 50Ω 1710 to 1910 MHz, Pin +26 dBm, 50Ω			-36 -36 -36	dBm dBm dBm
	Series <sup>5</sup>	470 to 582 MHz, Pin +20 dBm, 50Ω 698 to 915 MHz, Pin +20 dBm, 50Ω 1710 to 1910 MHz, Pin +20 dBm, 50Ω			-36 -36 -36	dBm dBm dBm
3rd Order Intercept Point	Shunt <sup>6</sup>	IIP3 = (Pblocker + 2*Ptx - [IMD3]) / 2, where IMD3 = -95 dBm, Ptx = +20 dBm and Pblocker = -15 dBm		60		dBm
Switching Time <sup>2,3</sup>	Shunt <sup>6</sup>	State change to 10/90% delta capacitance between any two states		2	10	μs
Start-up Time <sup>2</sup>	Shunt <sup>6</sup>	Time from V <sub>DD</sub> within specification to all performances within specification		5	20	μs
Wake-up Time <sup>2,3</sup>	Shunt <sup>6</sup>	State change from standby mode to RF state to all performances within specification		5	20	μs

Note: 1. Q for a Shunt DTC based on a Series RLC equivalent circuit  
 $Q = X_C / R = (X - X_L) / R$ , where  $X = X_L + X_C$ ,  $X_L = 2 * \pi * f * L$ ,  $X_C = -1 / (2 * \pi * f * C)$ , which is equal to removing the effect of parasitic inductance L<sub>s</sub>  
2. DC path to ground at RF+ and RF- must be provided to achieve specified performance  
3. State change activated on falling edge of SEN following data word  
4. Between 50Ω ports in series or shunt configuration using a pulsed RF input with 4620 vs period, 50% duty cycle, measured per 3GPPTS45.005  
5. In series configuration the greater RF power or higher RF voltage should be applied to RF+  
6. RF- should be connected to ground  
7. DTC operation above SRF is possible

Figure 3. Pin Configuration (Top View)

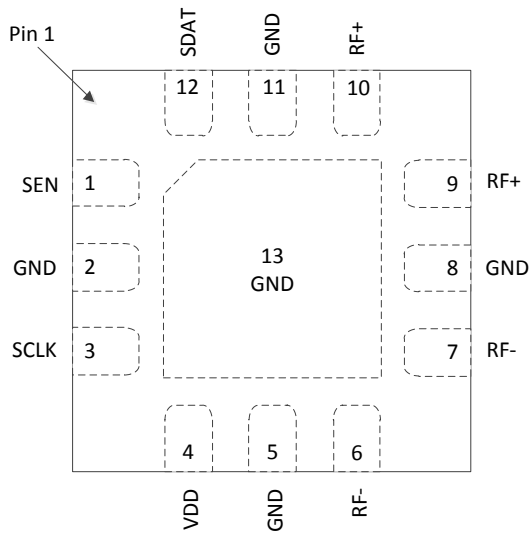

Table 2. Pin Descriptions

Pin #	Pin Name	Description
1	SEN	Serial Enable
2	GND	Digital and RF Ground
3	SCLK	Serial Interface Clock Input
4	VDD	Power Voltage
5	GND	Digital and RF Ground
6	RF-	Negative RF Port <sup>1</sup>
7	RF-	Negative RF Port <sup>1</sup>
8	GND	Digital and RF Ground <sup>3</sup>
9	RF+	Positive RF Port <sup>2</sup>
10	RF+	Positive RF Port <sup>2</sup>
11	GND	Digital and RF Ground
12	SDAT	Serial Interface Data Input
13	GND	Digital and RF Ground <sup>3</sup>

Notes: 1. Pins 6 and 7 must be tied together on PCB board to reduce inductance  
 2. Pins 9 and 10 must be tied together on PCB board to reduce inductance  
 3. Pin 2, 5, 8, 11 and 13 must be connected together on PCB

**Moisture Sensitivity Level**

The Moisture Sensitivity Level rating for the PE64101 in the 12-lead 2 x 2 QFN package is MSL1.

**Latch-Up Avoidance**

Unlike conventional CMOS devices, UltraCMOS<sup>®</sup> devices are immune to latch-up.

Table 3. Operating Ranges<sup>1</sup>

Parameter	Symbol	Min	Typ	Max	Units
V <sub>DD</sub> Supply Voltage	V <sub>DD</sub>	2.3	2.8	3.6	V
I <sub>DD</sub> Power Supply Current (Normal mode) <sup>6</sup>	I <sub>DD</sub>		30	75	μA
I <sub>DD</sub> Power Supply Current (Standby mode) <sup>6</sup>	I <sub>DD</sub>		20	45	μA
Control Voltage High	V <sub>IH</sub>	1.2		3.1	V
Control Voltage Low	V <sub>IL</sub>	0		0.2	V
Peak Operating RF Voltage <sup>5</sup>				6	V <sub>PK</sub>
V <sub>P</sub> to V <sub>M</sub>				6	V <sub>PK</sub>
V <sub>P</sub> to RFGND				6	V <sub>PK</sub>
V <sub>M</sub> to RFGND				6	V <sub>PK</sub>
RF Input Power (50Ω) <sup>3,4,5</sup>				+26 +20	dBm dBm
					shunt series
Input Control Current	I <sub>CTL</sub>		1	10	μA
Operating Temperature Range	T <sub>OP</sub>	-40		+85	°C
Storage Temperature Range	T <sub>ST</sub>	-65		+150	°C

Notes: 1. Operation should be restricted to the limits in the Operating Ranges table  
 2. The DTC is active when STBY is low (set to 0) and in low-current stand-by mode when high (set to 1)  
 3. Maximum CW power available from a 50Ω source in shunt configuration  
 4. Maximum CW power available from a 50Ω source in series configuration  
 5. RF+ to RF- and RF+ and/or RF- to ground. Cannot exceed 6 V<sub>PK</sub> or max RF input power (whichever occurs first)  
 6. I<sub>DD</sub> current typical value is based on V<sub>DD</sub> = 2.8V. Max I<sub>DD</sub> is based on V<sub>DD</sub> = 3.6V

Table 4. Absolute Maximum Ratings

Symbol	Parameter/Conditions	Min	Max	Units
V <sub>DD</sub>	Power supply voltage	-0.3	4.0	V
V <sub>I</sub>	Voltage on any DC input	-0.3	4.0	V
V <sub>ESD</sub>	ESD Voltage (HBM, MIL_STD 883 Method 3015.7)		2000	V
V <sub>ESD</sub>	ESD Voltage (MM, JEDEC JESD22-A115-A)		100	V

Exceeding absolute maximum ratings may cause permanent damage. Operation between operating range maximum and absolute maximum for extended periods may reduce reliability.

**Electrostatic Discharge (ESD) Precautions**

When handling this UltraCMOS<sup>®</sup> device, observe the same precautions that you would use with other ESD-sensitive devices. Although this device contains circuitry to protect it from damage due to ESD, precautions should be taken to avoid exceeding the specified rating.

Performance Plots @ 25°C and 2.8V unless otherwise specified

Figure 4. Measured Shunt C (@ 100 MHz) vs State (temperature)

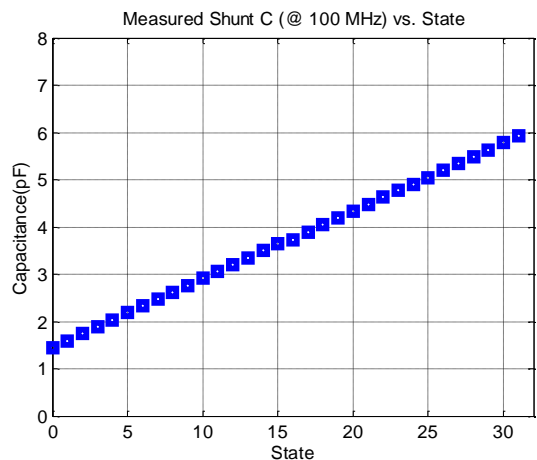

Figure 5. Measured Shunt S<sub>11</sub> (major states)

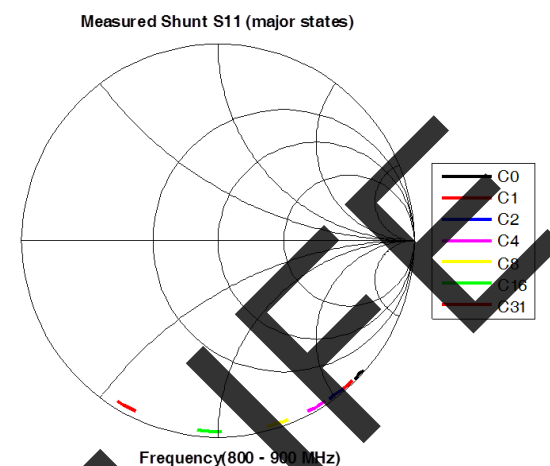

Figure 6. Measured Step Size vs State (frequency)

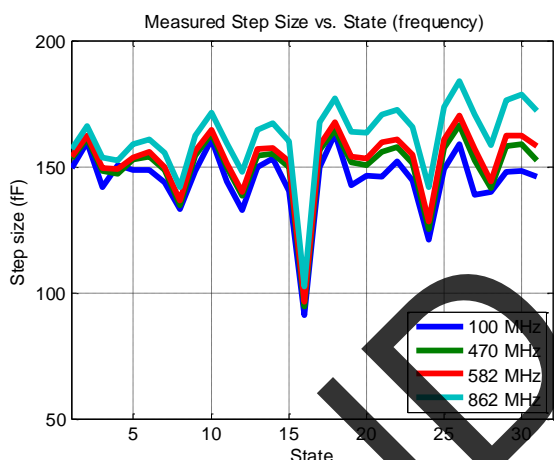

Figure 7. Measured Series S<sub>11</sub>/S<sub>22</sub> (major states)

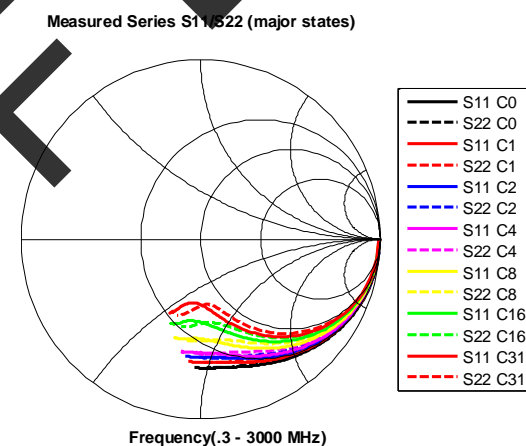

Figure 8. Measured Shunt C vs Frequency (major states)

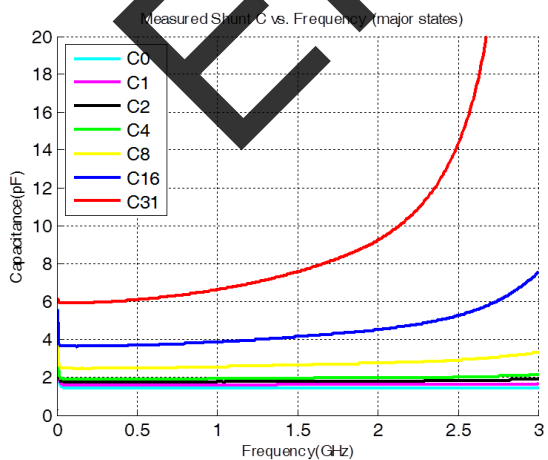
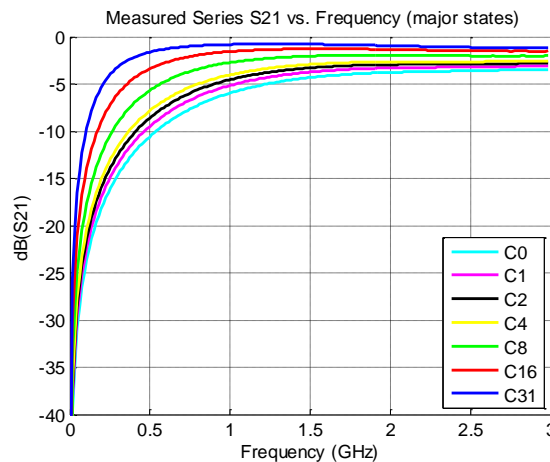
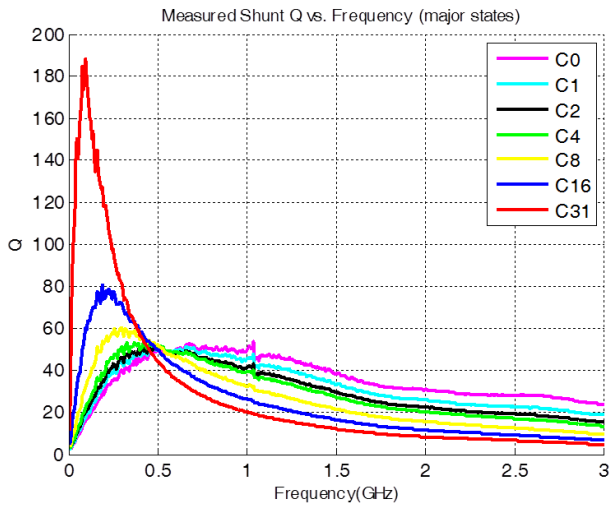

Figure 9. Measured Series S<sub>21</sub> vs Frequency (major states)



**Figure 10. Measured Shunt Q vs Frequency (major states)**



**Figure 11. Measured 2-Port Shunt S21 vs Frequency (major states)**

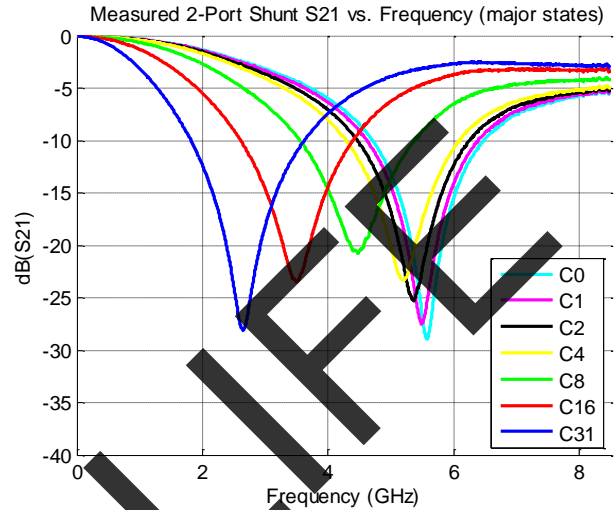

**Figure 12. Measured Self Resonance Frequency vs State**

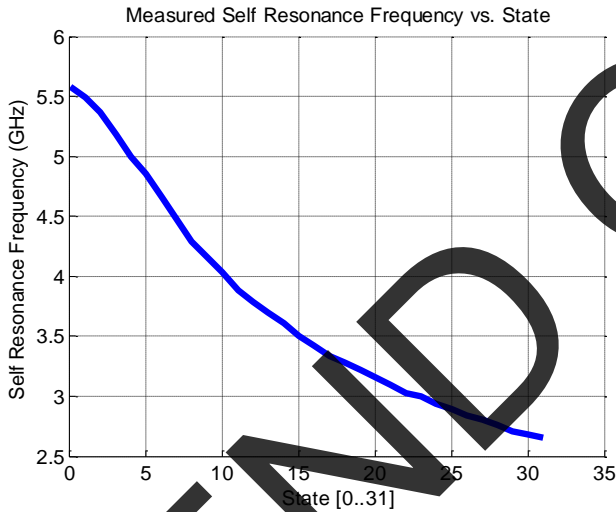

**Figure 13. Measured Shunt Q vs State**

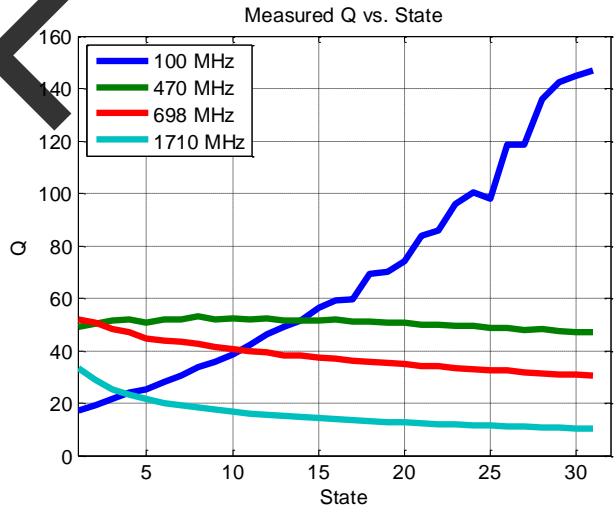

### Serial Interface Operation and Sharing

The PE64101 is controlled by a three wire SPI-compatible interface. As shown in *Figure 14*, the serial master initiates the start of a telegram by driving the SEN (Serial Enable) line high. Each bit of the 8-bit telegram is clocked in on the rising edge of the SCL (Serial Clock) line. SDA bits are clocked by most significant bit (MSB) first, as shown in *Table 5* and *Figure 14*. Transactions on SDA (Serial Data) are allowed on the falling edge of SCL. The DTC activates the data on the falling edge of SEN. The DTC does not count how many bits are clocked and only maintains the last 8 bits it received.

More than 1 DTC can be controlled by one interface by utilizing a dedicated enable (SEN) line for each DTC. SDA, SCL, and  $V_{DD}$  lines may be shared as shown in *Figure 15*. Dedicated SEN lines act as a chip select such that each DTC will only respond to serial transactions intended for them. This makes each DTC change states sequentially as they are programmed.

Alternatively, a dedicated SDA line with common SEN can be used. This allows all DTCs to change states simultaneously, but requires all DTCs to be programmed even if the state is not changed.

Figure 14. Serial Interface Timing Diagram (oscilloscope view)

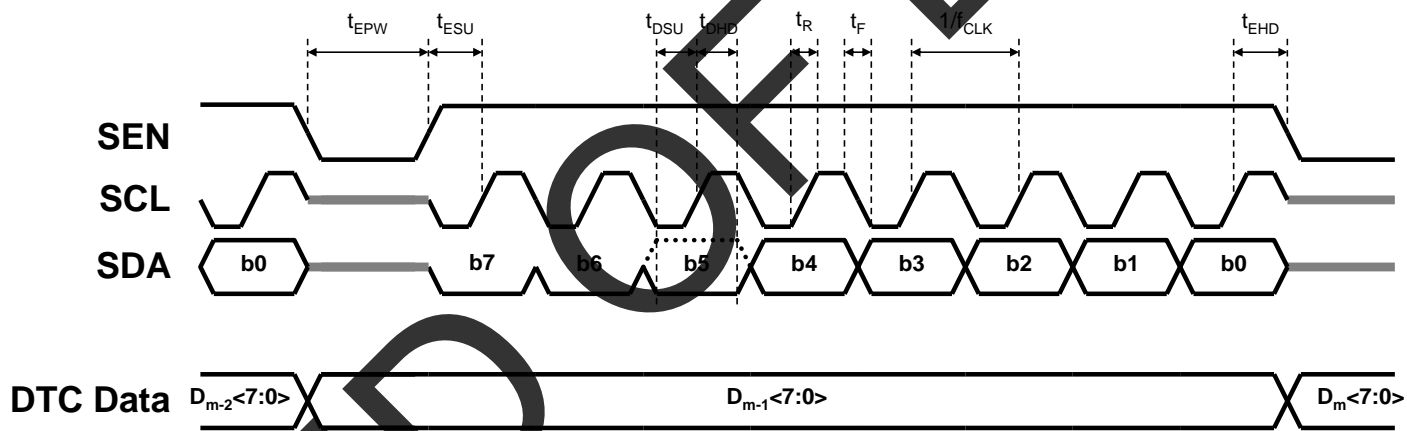

**Table 5. 6-Bit Serial Programming Register Map**

b7	b6	b5	b4	b3	b2	b1	b0
0	0	STB <sup>1</sup>	d4	d3	d2	d1	d0

MSB (first in)

LSB (last in)

Note: 1. The DTC is active when low (set to 0) and in low-current stand-by mode when high (set to 1)

**Table 6. Serial Interface AC Characteristics**

2.3V < V<sub>DD</sub> < 3.6V, -40 °C < T<sub>A</sub> < +85 °C, unless otherwise specified

Symbol	Parameter	Min	Max	Unit
f <sub>CLK</sub>	Serial Clock Frequency		26	MHz
t <sub>R</sub>	SCL, SDA, SEN Rise Time		6.5	ns
t <sub>F</sub>	SCL, SDA, SEN Fall Time		6.5	ns
t <sub>ESU</sub>	SEN rising edge to SCL rising edge	19.2		ns
t <sub>EHD</sub>	SCL rising edge to SEN falling edge	19.2		ns
t <sub>DSU</sub>	SDA valid to SCL rising edge	13.2		ns
t <sub>DHD</sub>	SDA valid after SCL rising edge	13.2		ns
t <sub>EOW</sub>	SEN falling edge to SEN rising edge	38.4		ns

**Figure 15. Recommended Bus sharing**

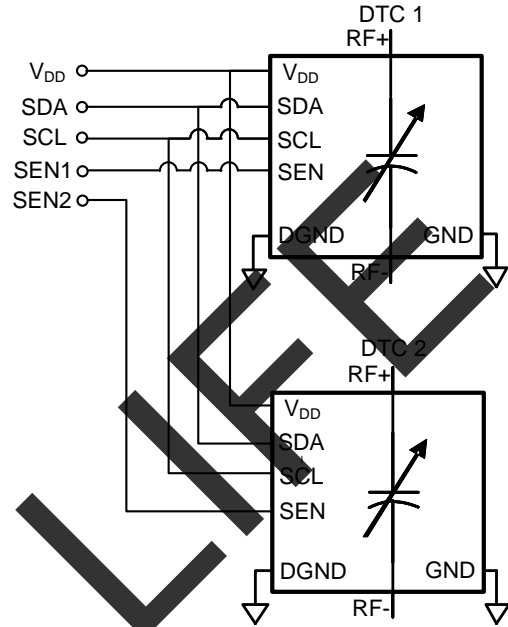

END OF PAGE

### Equivalent Circuit Model Description

The DTC Equivalent Circuit Model includes all parasitic elements and is accurate in both Series and Shunt configurations, reflecting physical circuit behavior accurately and providing very close correlation to measured data. It can easily be used in circuit simulation programs. Simple equations are provided for the state dependent parameters. The Tuning Core capacitance  $C_S$  represents capacitance between RF+ and RF- ports. It is linearly proportional to state (0 to 31 in decimal) in a discrete fashion. The Series Tuning Ratio is defined as  $C_{Smax}/C_{Smin}$ .

$C_{P1}$  and  $C_{P2}$  represent the circuit and package parasitics from RF ports to GND. In shunt configuration the total capacitance of the DTC is higher due to parallel combination of  $C_P$  and  $C_S$ . In Series configuration,  $C_S$  and  $C_P$  do not add in parallel and the DTC appears as an impedance transformation network.

Parasitic inductance due to circuit and package is modeled as  $L_S$  and causes the apparent capacitance of the DTC to increase with frequency until it reaches Self Resonant Frequency (SRF). The value of SRF depends on state and is approximately inversely proportional to the square root of capacitance.

The overall dissipative losses of the DTC are modeled by  $R_S$ ,  $R_{P1}$  and  $R_{P2}$  resistors. The parameter  $R_S$  represents the Equivalent Series Resistance (ESR) of the tuning core and is dependent on state.  $R_{P1}$  and  $R_{P2}$  represent losses due to the parasitic and biasing networks.

Figure 16. Equivalent Circuit Model Schematic

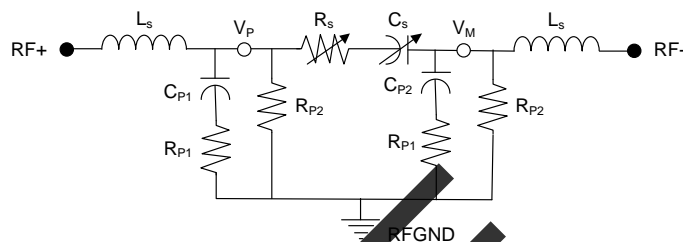

Table 7. Equivalent Circuit Model Parameters

Variable	Equation (state = 0, 1, 2...31)	Unit
$C_S$	$0.148 * state + 0.97$	pF
$R_S$	$30 / (state + 30 / (state + 0.4)) + 0.4$	$\Omega$
$C_{P1}$	$-0.0022 * state + 0.4005$	pF
$C_{P2}$	$0.0026 * state + 0.5092$	pF
$R_{P1}$	4	$\Omega$
$R_{P2}$	$22000 + 6 * (state)^3$	$\Omega$
$L_S$	0.4	nH

Table 8. Maximum Operating RF Voltage

Condition	Limit
$V_P$ to $V_M$	$6 V_{PK}$
$V_P$ to RFGND	$6 V_{PK}$
$V_M$ to RFGND	$6 V_{PK}$



**Table 9. Equivalent Circuit Data**

State		DTC Core		Parasitic Elements				
Binary	Decimal	Cs [pF]	Rs [ $\Omega$ ]	Cp1 [pF]	Cp2 [pF]	Rp2 [k $\Omega$ ]	Ls [nH]	Rp1 [ $\Omega$ ]
00000	0	0.97	0.80	0.40	0.51	22.0	0.40	4.0
00001	1	1.12	1.73	0.40	0.51	22.0		
00010	2	1.27	2.41	0.40	0.51	22.0		
00011	3	1.41	2.81	0.39	0.52	22.2		
00100	4	1.56	2.98	0.39	0.52	22.4		
00101	5	1.71	3.00	0.39	0.52	22.8		
00110	6	1.86	2.92	0.39	0.52	23.3		
00111	7	2.01	2.81	0.39	0.53	24.1		
01000	8	2.15	2.68	0.38	0.53	25.1		
01001	9	2.30	2.54	0.38	0.53	26.4		
01010	10	2.45	2.42	0.38	0.54	28.0		
01011	11	2.60	2.29	0.38	0.54	30.0		
01100	12	2.75	2.18	0.37	0.54	32.4		
01101	13	2.89	2.08	0.37	0.54	35.2		
01110	14	3.04	1.99	0.37	0.55	38.5		
01111	15	3.19	1.90	0.37	0.55	42.3		
10000	16	3.34	1.83	0.37	0.55	46.6		
10001	17	3.49	1.76	0.36	0.55	51.3		
10010	18	3.63	1.69	0.36	0.56	57.0		
10011	19	3.78	1.63	0.36	0.56	63.2		
10100	20	3.93	1.58	0.36	0.56	70.0		
10101	21	4.08	1.53	0.35	0.56	77.6		
10110	22	4.23	1.48	0.35	0.57	85.9		
10111	23	4.37	1.44	0.35	0.57	95.0		
11000	24	4.52	1.40	0.35	0.57	104.9		
11001	25	4.67	1.36	0.35	0.57	115.8		
11010	26	4.82	1.33	0.34	0.58	127.4		
11011	27	4.97	1.30	0.34	0.58	140.1		
11100	28	5.11	1.27	0.34	0.58	153.7		
11101	29	5.26	1.24	0.34	0.58	168.3		
11110	30	5.41	1.21	0.33	0.59	184.0		
11111	31	5.56	1.19	0.33	0.59	200.7		

### Evaluation Board

The 101-0700 Evaluation Board (EVB) was designed for accurate measurement of the DTC impedance and loss. Two configurations are available: 1 Port Shunt (J3) and 2 Port Shunt (J4, J5). Three calibration standards are provided. The open (J2) and short (J1) standards (104 ps delay) are used for performing port extensions and accounting for electrical length and transmission line loss. The Thru (J9, J10) standard can be used to estimate PCB transmission line losses for scalar de-embedding of the 2 Port Shunt configuration (J4, J5).

The board consists of a 4 layer stack with 2 outer layers made of Rogers 4350B ( $\epsilon_r = 3.48$ ) and 2 inner layers of FR4 ( $\epsilon_r = 4.80$ ). The total thickness of this board is 62 mils (1.57 mm). The inner layers provide a ground plane for the transmission lines. Each transmission line is designed using a coplanar waveguide with ground plane (CPWG) model using a trace width of 32 mils (0.813 mm), gap of 15 mils (0.381 mm), and a metal thickness of 1.4 mils (0.036 mm).

**Figure 17. Evaluation Board Layout**

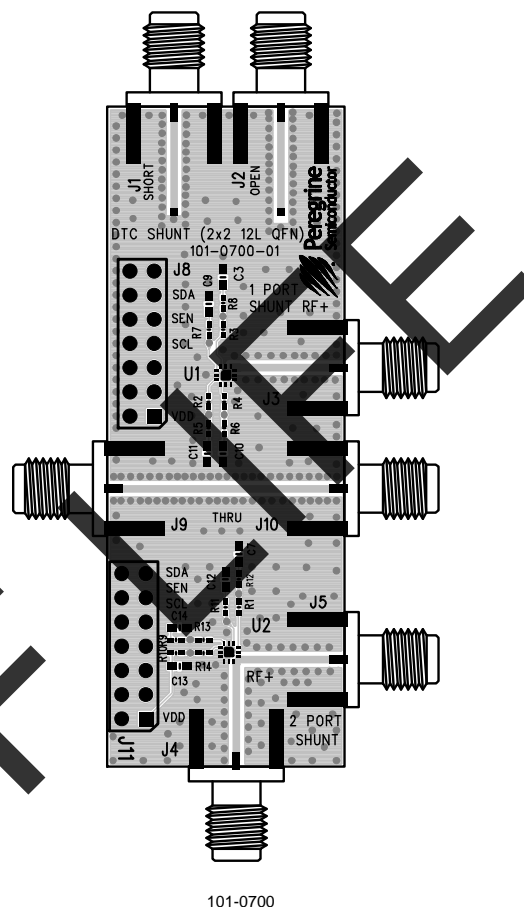

END OF FILE

Figure 18. Evaluation Board Schematic

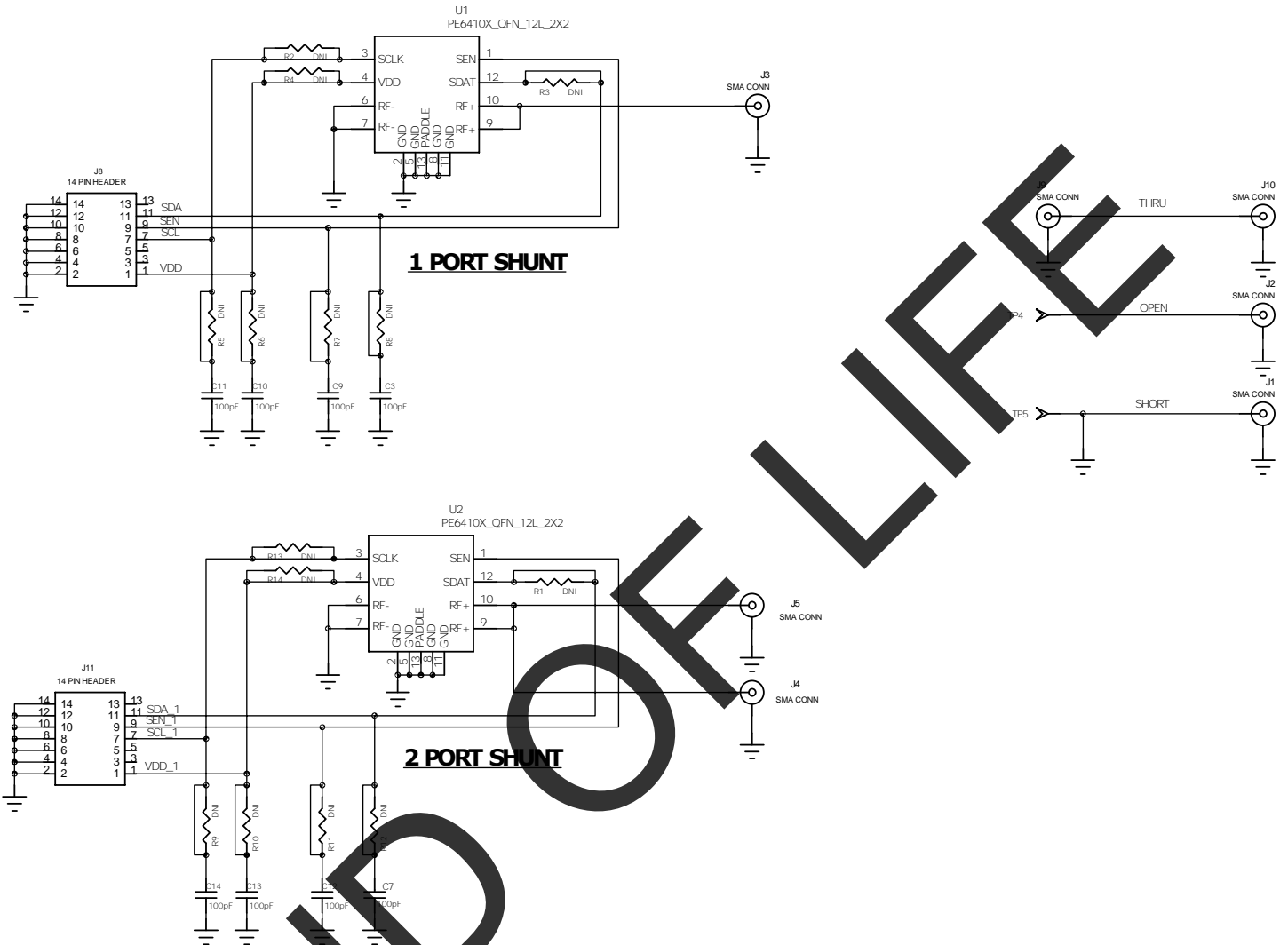

END OF LIFE

**Figure 19. Package Drawing**  
12-lead 2 x 2 x 0.55 mm QFN

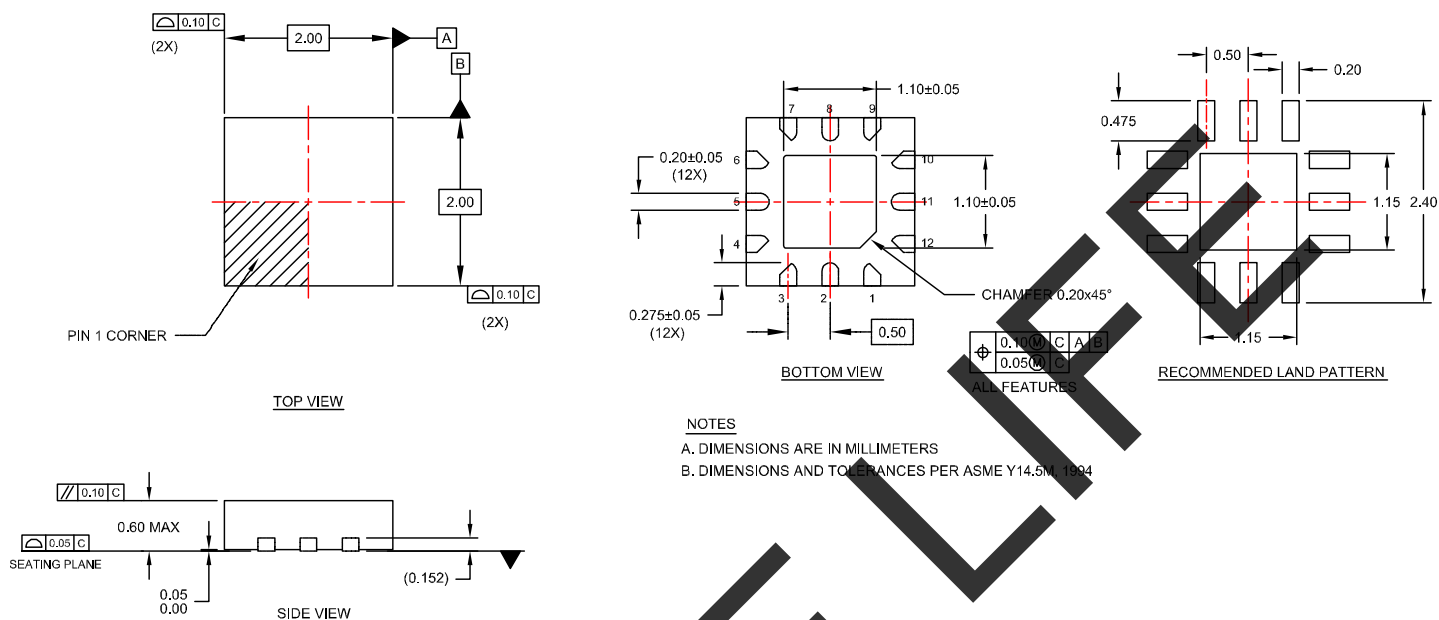

**Figure 20. Top Marking Specifications**

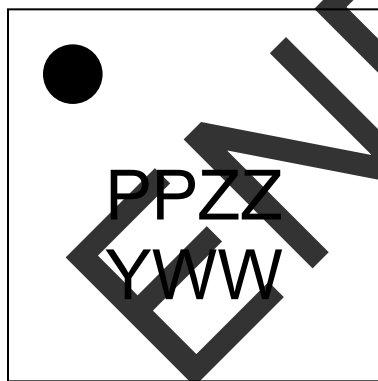

17-0112

Marking Spec Symbol	Package Marking	Definition
PP	CR	Part number marking for PE64101
ZZ	00-99	Last two digits of lot code
Y	0-9	Last digit of year, starting from 2009 (0 for 2010, 1 for 2011, etc)
WW	01-53	Work week

**Figure 21. Tape and Reel Specifications**  
12-lead 2 x 2 x 0.55 mm QFN

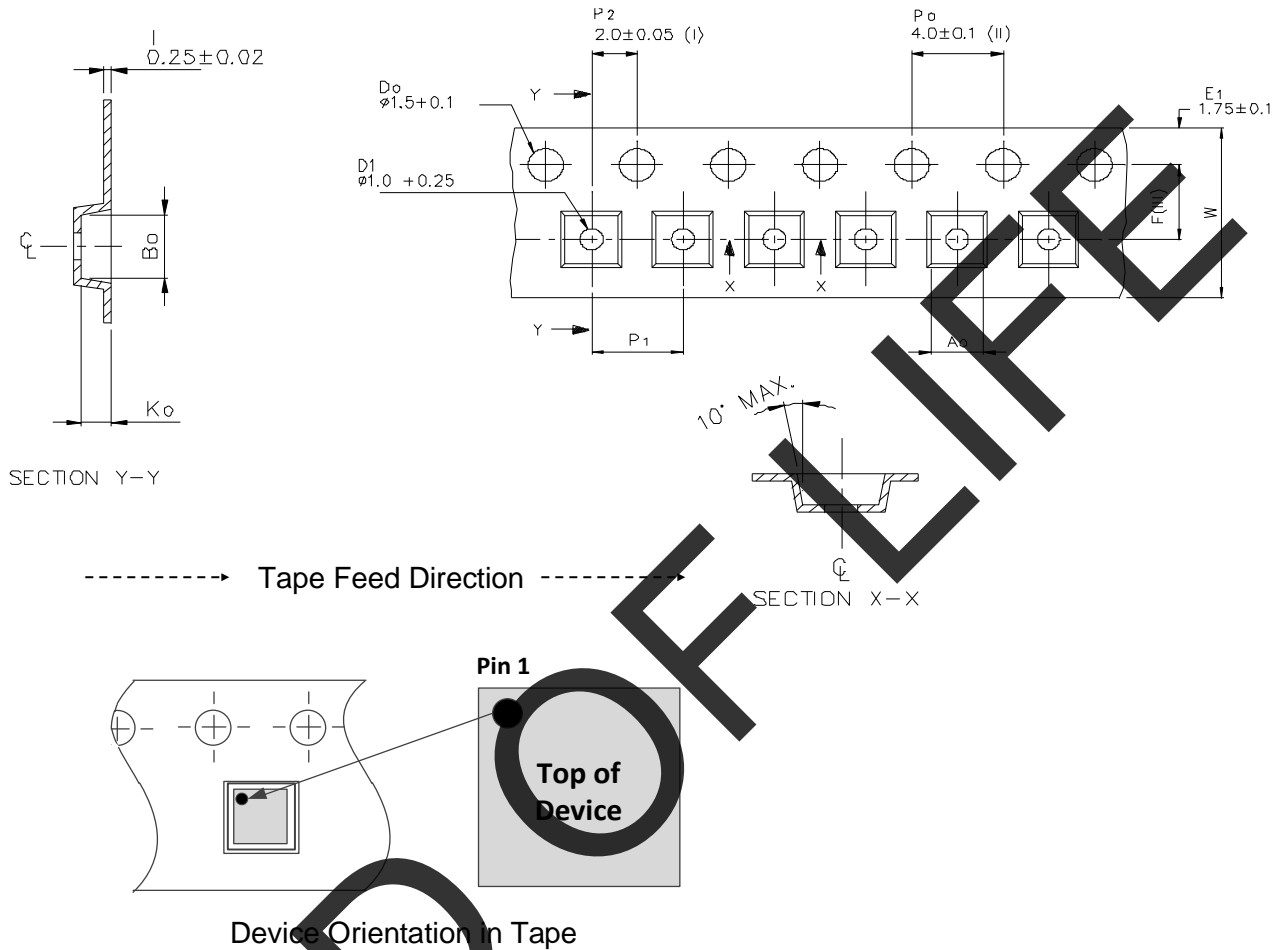

**Table 10. Ordering Information**

Order Code	Package	Description	Shipping Method
PE64101MLAA-Z	12-lead 2 x 2 x 0.55 mm QFN	Package Part in Tape and Reel	3000 units/T&R
EK64101-11	Evaluation Kit	Evaluation Kit	1 Set/Box

**Sales Contact and Information**

For sales and contact information please visit [www.psemi.com](http://www.psemi.com).

**Advance Information:** The product is in a formative or design stage. The datasheet contains design target specifications for product development. Specifications and features may change in any manner without notice.  
**Preliminary Specification:** The datasheet contains preliminary data. Additional data may be added at a later date. Peregrine reserves the right to change specifications at any time without notice in order to supply the best possible product.  
**Product Specification:** The datasheet contains final data. In the event Peregrine decides to change the specifications, Peregrine will notify customers of the intended changes by issuing a CNF (Customer Notification Form).  
 The information in this datasheet is believed to be reliable. However, Peregrine assumes no liability for the use of this information. Use shall be entirely at the user's own risk.

No patent rights or licenses to any circuits described in this datasheet are implied or granted to any third party. Peregrine's products are not designed or intended for use in devices or systems intended for surgical implant, or in other applications intended to support or sustain life, or in any application in which the failure of the Peregrine product could create a situation in which personal injury or death might occur. Peregrine assumes no liability for damages, including consequential or incidental damages, arising out of the use of its products in such applications.  
 The Peregrine name, logo, UltraCMOS and UTSi are registered trademarks and HaRP, MultiSwitch and DuNE are trademarks of Peregrine Semiconductor Corp.

## X-ON Electronics

Largest Supplier of Electrical and Electronic Components

*Click to view similar products for [Interface - Specialized category](#):*

*Click to view products by [pSemi manufacturer](#):*

Other Similar products are found below :

[CY7C910-51LMB](#) [MC33689DPEWR2](#) [MC33975TEKR2](#) [MEC1632-AUE](#) [MC33978AEK](#) [NVT4555UKZ](#) [TJA1081TS,112](#) [RKSAS4](#)  
[HMC677G32](#) [LPC47N207-JV](#) [FTP-637DSL633R](#) [MAX7348AEP+](#) [SM712GX04LF04-BA](#) [DS2413P+T&R](#) [NCN5193MNTWG](#)  
[MC34978AEK](#) [MC33689DPEW](#) [MC33889BPEG](#) [NCV7381DP0R2G](#) [PCA9704PWJ](#) [S6BT112A01SSBB202](#) [MAX7347AEE+](#) [DS8113-](#)  
[RNG+T&R](#) [DS8024-RJX+T&R](#) [NCN5192MNRG](#) [DS8023-RRX+T&R](#) [DS8024-RRX+T&R](#) [ST8034HCQR](#) [XP71055](#)  
[TC7PCI3212MT,LF\(S](#) [ASI4UE-F-G1-ST](#) [HOA6241-001](#) [MEC1310-NU](#) [SC74HC4066ADTR2G](#) [TDA8035HNC1S1QL](#) [TNY380PN](#)  
[RMT3PB080](#) [AS3935-BQFT](#) [0714300268](#) [MAX9924UAUB/V+](#) [MAX3120CUA+](#) [MAX3171CAI](#) [NCN8025MTTBG](#) [DS8023-RRX](#)  
[DS2406P+T&R](#) [DS8007-ENG+](#) [DS8007A-EAG+](#) [DS2482X-101T](#) [DS1886T+](#) [DG407AK/883B](#)