

Juno[®] Family of Velocity & Torque Control ICs

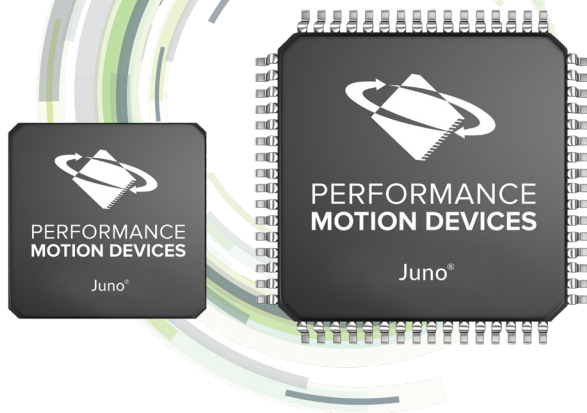

The Juno Family of ICs provide advanced velocity and torque control for Brushless DC, DC Brush, and step motors. They are the industry's first family of compact ICs with full four quadrant motion control, direct input quadrature encoder, profile generation, and advanced current control.

Juno ICs are targeted for medical, scientific, industrial, and robotic applications that need to minimize motor noise, vibration and power consumption. Juno ICs are easy to deploy with embedded motion commands, on-board intelligence, and direct analog and digital amplifier signal interfacing.

Easy Integration

Juno ICs interface to external bridge-type switching amplifiers and utilize Performance Motion Device's proprietary current and switch-signal technology for ultra smooth operation. Depending on the type of motor controlled, Juno ICs provide motor commutation, microstep generation, pulse and direction input, internal profile generation, and much more.

Integrated Safety Features

Juno ICs are equipped with advanced amplifier management features such as overcurrent, over/undervoltage, and overtemperature sense. A special outer control loop allows a wide range of motor-related control applications, including pressure, flow rate and temperature control.

Flexible Offering

Juno ICs are offered in three major product groups:

- Juno Velocity Control ICs
- Juno Step Motor Control ICs
- Juno Torque Control ICs

No matter what your motor control application, there is a Juno IC that will take your application to a higher level.

MEET THE FAMILY

- **Velocity Control ICs:** Sophisticated velocity and torque control of 3-phase DC Brush and Brushless DC motors
- **Torque Control ICs:** Ultra precise torque control for 3-phase Brushless DC and DC Brush motors with direct analog or SPI command input
- **Step Motor Control ICs:** State of the art step motor control with pulse and direction or SPI command input

FEATURES

- Controls 3-phase DC Brush, Brushless DC, or step motors
- High performance digital current loop
- Velocity loop with encoder or tachometer feedback
- Internal profile generator
- Sinusoidal or 6-step commutation
- Field oriented control
- Hall sensor inputs
- PWM output with shoot-through protection
- Direct analog signal input
- Serial port up to 460 kbaud
- Quadrature encoder input up to 40 Mcounts/sec
- NVRAM configuration load and trace memory
- Compact 64-pin TQFP and ultra-compact 56-pin VQFN packages
- High speed index input and capture
- SPI (serial peripheral interface) command input
- Brake signal input
- 10 kHz velocity loop
- 20, 40, 80, 120 kHz PWM rate
- 20 or 40 kHz commutation and current loop rate
- i2t current foldback protection
- Over and under-voltage protection
- Pulse and direction input

CONFIGURATION

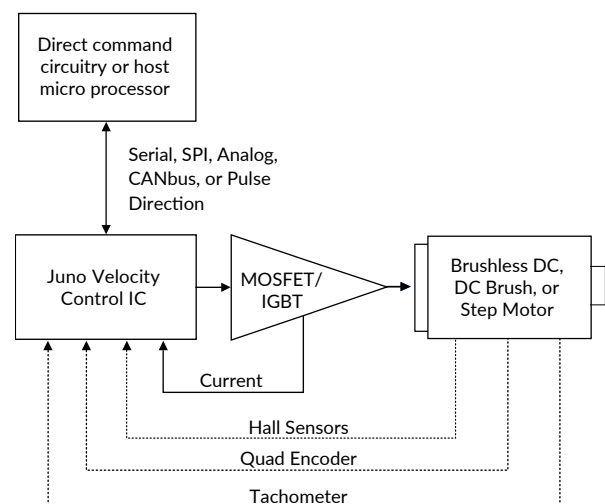

TECHNICAL OVERVIEW

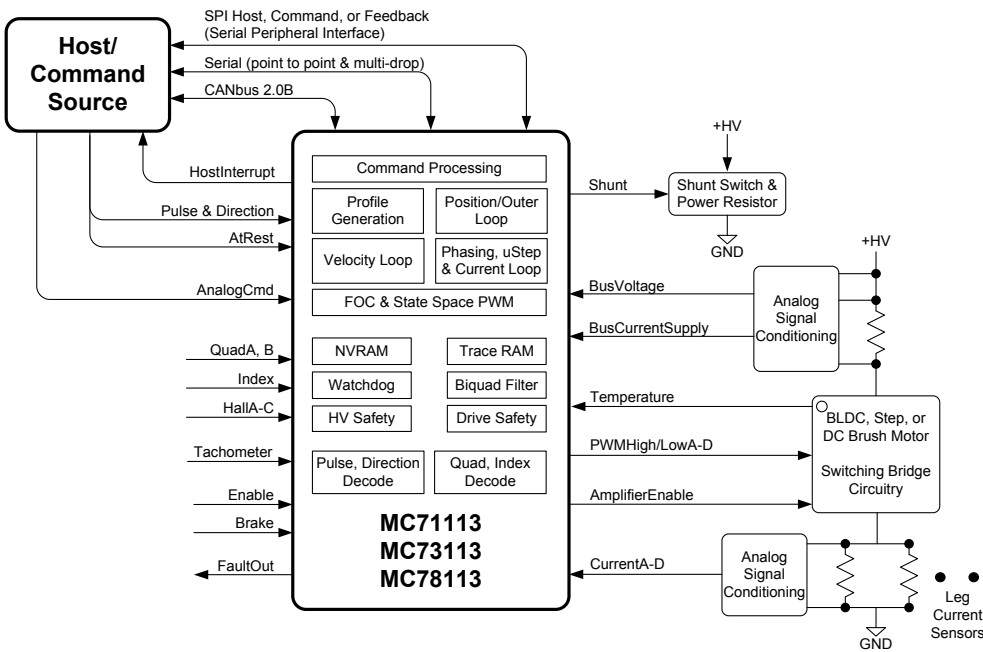

PART NUMBERS

MC71113	64-pin TQFP DC Brush
MC73113	64-pin TQFP Brushless DC
MC81113	64-pin TQFP DC Brush Brushless DC Step (motor type user set)

SPECIFICATIONS – JUNO VELOCITY CONTROL ICs

Parameters	Value
Motors supported	3-phase Brushless DC, DC Brush, 2-phase step motor
Operating modes	Standalone: direct command input via external circuitry (onboard NVRAM holds configuration), Host command: microprocessor command input
Control loops	Position/outer loop, velocity loop, current loop
Current control modes	FOC (field oriented control), Third leg floating, Single-phase, Voltage mode (no current control)
Commutation modes	6-step (using Hall sensors) Sinusoidal (with quadrature encoder input)
Motor output modes	Individual high/low PWM, Sign/Magnitude PWM
Microstep per full step	Programmable up to 256 microsteps/full step
Profile generator parameters	Velocity, acceleration, deceleration
Communication modes	Point-to-point asynchronous serial, Multi-drop asynchronous serial, SPI, or CANbus 2.0
Serial baud rate range	1,200 to 460,800 baud
CANbus baud rate range	10,000 to 1,000,000 baud
Internal trace RAM	6,144 16-bit words
Internal NVRAM	1,024 16-bit words

Parameters	Value
Velocity feedback options	Quadrature encoder, Hall sensors, analog tachometer signal (12-bit A/D resolution)
Position command options	Pulse and direction, Digital SPI (16-bit resolution), Internal profile generator
Velocity and torque command options	Analog signal (12-bit A/D resolution), Digital SPI (16-bit resolution), Internal profile generator
Control/status signals	Enable, FaultOut, Hostinterrupt, Brake
Motor drive signals	PWM High/LowA-D, AmplifierEnable, CurrentA-D
DC Bus safety signals	Shunt, BusVoltage, BusCurrentSupply, Temperature
Motor feedback signals	QuadA, QuadB, Index, HallA-C, Tachometer, digital SPI
Max quadrature rate	40 Mcounts/second
Max SPI frequency	10 MHz
Position/outer loop rate	Programmable up to 10 kHz
Velocity loop rate	Programmable up to 10 kHz
Current loop rate	20 kHz
Commutation rate	20 kHz
PWM rate	20, 40, 80, 120 kHz
Dimension	64-pin TQFP: 12 mm x 12 mm including leads

JUNO® TORQUE CONTROL ICs

TECHNICAL OVERVIEW

PART NUMBERS

MC71112	64-pin TQFP DC Brush
MC71112N	56-pin VQFN DC Brush
MC73112	64-pin TQFP Brushless DC
MC73112N	56-pin VQFN Brushless DC

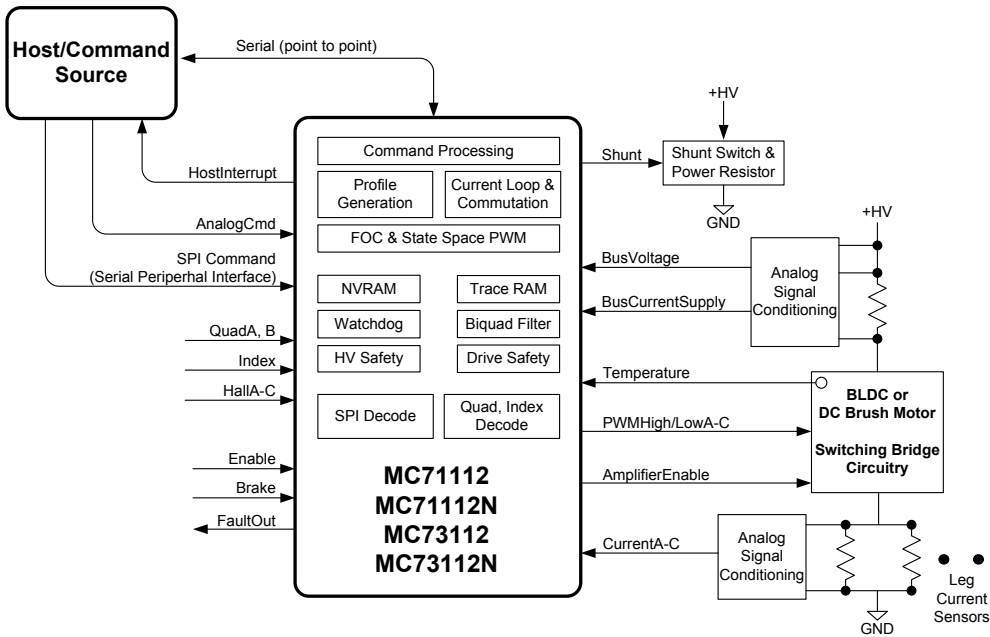

SPECIFICATIONS – JUNO TORQUE CONTROL ICs

Parameters	Value
Motors supported	3-phase Brushless DC, DC Brush
Operating modes	Standalone: direct command input via external circuitry (onboard NVRAM holds configuration), Host command: microprocessor command input via serial
Control loops	Current loop
Commutation modes	6-step (using Hall sensors), Sinusoidal (with quadrature encoder input)
Current control modes	FOC (field oriented control), Third leg floating, Single-phase, Voltage mode (no current control)
Motor output modes	Individual high/low PWM, Sign/Magnitude PWM
Communication modes	Point-to-point asynchronous serial
Serial baud rate range	1,200 to 460,800 baud
Internal trace RAM	6,144 16-bit words
Internal NVRAM	1,024 16-bit words

Parameters	Value
Torque command options	Analog signal (12-bit A/D resolution), Digital SPI (16-bit resolution), Internal profile generator, Direct set register
Control/status signals	Enable, FaultOut, Hostinterrupt, Brake
Motor drive signals	PWM High/LowA-C, AmplifierEnable, CurrentA-C
DC Bus safety signals	Shunt, BusVoltage, BusCurrentSupply, Temperature
Motor feedback signals	QuadA, QuadB, Index, HallA-C
Max quadrature rate	40 Mcounts/second
Max SPI frequency	10 MHz
Current loop rate	20 kHz
Commutation rate	40 kHz
PWM rate	20, 40, 80, 120 kHz
Dimension	64-pin TQFP: 12 mm x 12 mm including leads 56-pin VQFN: 7.2 mm x 7.2 mm

JUNO® STEP MOTOR CONTROL ICs

TECHNICAL OVERVIEW

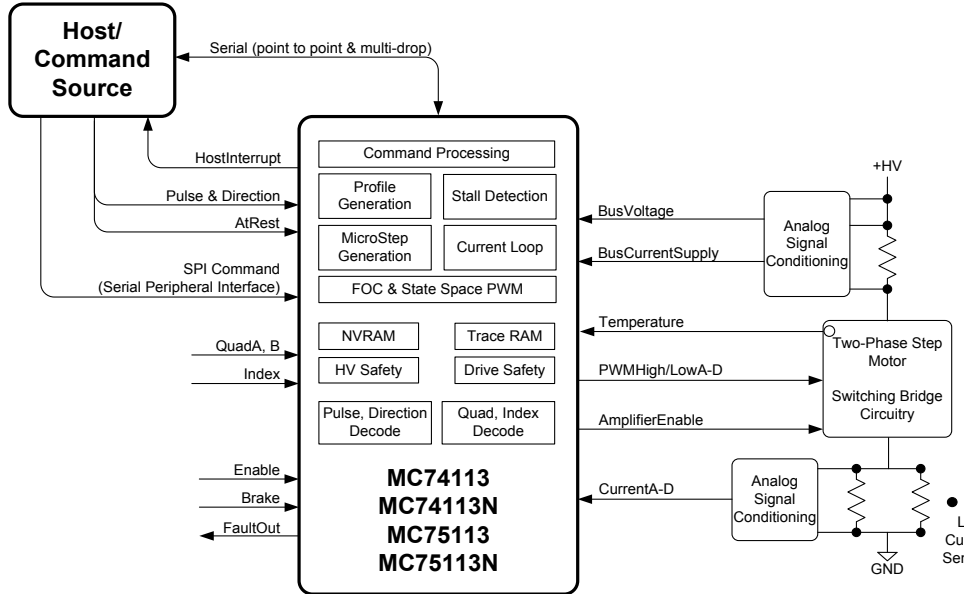

PART NUMBERS

MC74113	64-pin TQFP Step motor with encoder
MC74113N	56-pin VQFN Step motor with encoder
MC75113	64-pin TQFP Step motor
MC75113N	56-pin VQFN Step motor

SPECIFICATIONS – JUNO STEP MOTOR CONTROL ICs

Parameters	Value
Motors supported	2-phase step motor
Operating modes	Standalone: direct command input via external circuitry (onboard NVRAM holds configuration), Host command: microprocessor command input via serial
Control loops	Current loop
Current control modes	FOC (field oriented control), Voltage mode (no current control)
Motor output modes	Individual high/low PWM, Sign/Magnitude PWM
Microstep per full step	Programmable up to 256 microsteps/full step
Stall detection	Via encoder
Profile generator parameters	Velocity, acceleration, deceleration
Communication modes	Point-to-point asynchronous serial
Serial baud rate range	1,200 to 460,800 baud
Internal trace RAM	6,144 16-bit words
Internal NVRAM	1,024 16-bit words

Parameters	Value
Position command options (with AtRest signal)	Pulse and direction, Digital SPI (16-bit resolution), Internal profile generator
Control/status signals	Enable, FaultOut, Hostinterrupt, Brake
Motor drive signals	PWM High/LowA-D, AmplifierEnable, CurrentA-D
DC Bus safety signals	BusVoltage, BusCurrentSupply, Temperature
Motor feedback signals	QuadA, QuadB, Index
Max quadrature rate	40 Mcounts/second
Max SPI frequency	10 MHz
Current loop rate	20 kHz
Microstep synthesis rate	40 kHz
PWM rate	20, 40, 80, 120 kHz
Dimension	64-pin TQFP: 12 mm x 12 mm including leads 56-pin VQFN: 7.2 mm x 7.2 mm

Development Tools

1 EASY START-UP Developers Kit

INCLUDES

- MC78113, MC73112N, or MC74113N Developer Kit boards
- Pro-Motion software
- Software Development Kit (SDK) with C-Motion
- Complete manual set
- Complete cable connector set

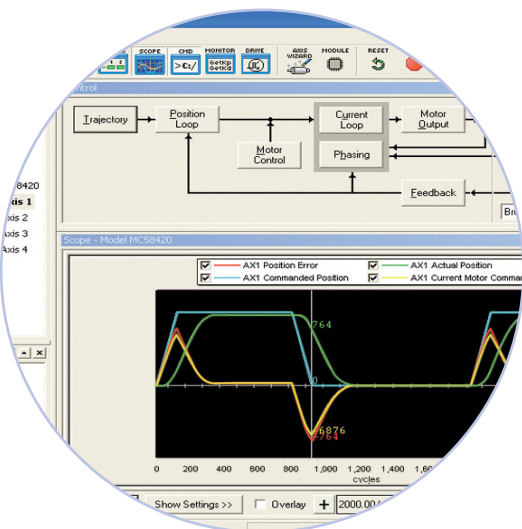

2 TUNE & OPTIMIZE Pro-Motion® GUI

Pro-Motion is a sophisticated, easy-to-use Windows-based exerciser program for use with PMD motion control ICs, modules, and cards.

FEATURES

- Motion oscilloscope graphically displays processor parameters in real-time
- Autotuning
- Ability to save and load settings
- Axis wizard
- Distance and time units conversion
- Motor-specific parameter setup
- Axis shuttle performs programmable motion between two positions
- Communications monitor echoes all commands sent by Pro-Motion to the board
- Advanced Bode analysis for frequency machine response

3 BUILD THE APP C-Motion®

C-Motion is a complete, easy-to-use, motion programming language that includes a source library containing all the code required for communicating with PMD motion ICs, boards, and modules.

C-MOTION FEATURES INCLUDE:

- Extensive library of commands for virtually all motion design needs
- Develop embeddable C/C++ applications
- Complete, functional examples
- Supports PC/104, serial, CAN, Ethernet, and SPI communications

```
code for executing a profile and trace...
captured in this example could be used for tuning the Pro
trace buffer wrap mode to a one time trace
TraceMode(hAxis1, PMDTraceOneTime);

at the processor variables that we want to capture
SetTraceVariable(hAxis1, PMDTraceVariable1, PMDAxis1,
SetTraceVariable(hAxis1, PMDTraceVariable2, PMDAxis1,
SetTraceVariable(hAxis1, PMDTraceVariable3, PMDAxis1, P

// set the trace to begin when we issue the next update command
SetTraceStart(hAxis1, PMDTraceConditionNextUpdate);

// set the trace to stop when the MotionComplete event occurs
SetTraceStop(hAxis1, PMDTraceConditionEventStatus,
PMDEventMotionCompleteBit, PMDTraceStateHigh);
SetProfileMode(hAxis1, PMDTrapezoidalProfile);

set the profile parameters
Position(hAxis1, 20000);
Velocity(hAxis1, 0x200000);
Acceleration(hAxis1, 0x1000);
Deceleration(hAxis1, 0x1000);

```

PMD PRODUCT FAMILY OVERVIEW

	# Axes	Motor Types	Format	Voltage	Communication	Features
JUNO® VELOCITY & TORQUE CONTROL ICs 	1	<ul style="list-style-type: none"> Brushless DC DC Brush Step Motor 	<ul style="list-style-type: none"> 64-pin TQFP 56-pin VQFN 	3.3 V	<ul style="list-style-type: none"> RS232/485 CANbus SPI 	<ul style="list-style-type: none"> Velocity control Current control Field oriented control
MAGELLAN® MOTION CONTROL ICs 	1,2,3,4	<ul style="list-style-type: none"> Brushless DC DC Brush Step Motor 	<ul style="list-style-type: none"> 144-pin TQFP 100-pin TQF 	3.3 V	<ul style="list-style-type: none"> RS232/485 CANbus SPI Parallel 	<ul style="list-style-type: none"> Position control Torque/current control Field oriented control Profile generation
ATLAS® DIGITAL AMPLIFIERS 	1	<ul style="list-style-type: none"> Brushless DC DC Brush Step Motor 	<ul style="list-style-type: none"> 20-pin solderable module 	12-56 V	<ul style="list-style-type: none"> SPI Pulse and direction 	<ul style="list-style-type: none"> Torque/current control Field oriented control MOSFET amplifier
ION®/CME N-SERIES DIGITAL DRIVES 	1	<ul style="list-style-type: none"> Brushless DC DC Brush Step Motor 	<ul style="list-style-type: none"> Fully enclosed PCB-mounted module 	12-56 V	<ul style="list-style-type: none"> Ethernet RS232/485 CAN FD SPI 	<ul style="list-style-type: none"> Position control Torque/current control Field oriented control Profile generation MOSFET amplifier Downloadable user code
ION® 500 & 3000 DIGITAL DRIVES 	1	<ul style="list-style-type: none"> Brushless DC DC Brush Step Motor 	<ul style="list-style-type: none"> Fully enclosed cable-connected module 	12-56 V 20-195 V	<ul style="list-style-type: none"> Ethernet RS232/485 CANbus 	<ul style="list-style-type: none"> Position control Torque/current control Field oriented control Profile generation MOSFET amplifier Downloadable user code
PRODIGY® MOTION BOARDS 	1,2,3,4	<ul style="list-style-type: none"> Brushless DC DC Brush Step Motor 	<ul style="list-style-type: none"> Machine Controller PC/104 Standalone 	<ul style="list-style-type: none"> 5 V: PC/104 and Standalone 12-56 V: Machine Controller 	<ul style="list-style-type: none"> Ethernet RS232/485 CANbus PC/104 bus 	<ul style="list-style-type: none"> Position control Torque/current control Field oriented control Profile generation Downloadable user code

C-Motion® is the common motion language for all Performance Motion Devices products.

FOR ORDERING

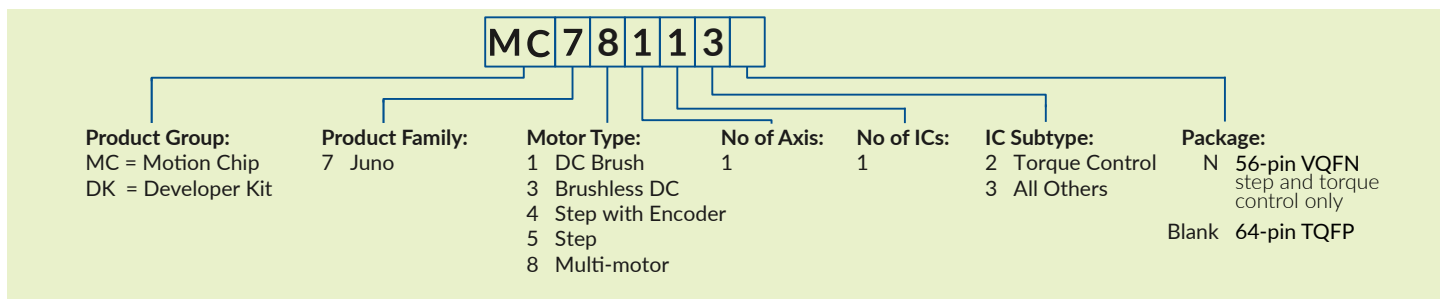

To place an order email purchaseorders@pmdcorp.com. For questions email support@pmdcorp.com

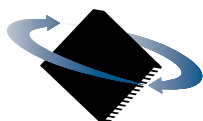

**PERFORMANCE
MOTION DEVICES**
MOTION CONTROL AT ITS CORE

1 Technology Park Dr, Westford, MA 01886
Tel: 978.266.1210 Fax: 978.266.1211
e-mail: info@pmdcorp.com
www.pmdcorp.com

About Performance Motion Devices

Performance Motion Devices (PMD) is a worldwide leader in motion control ICs, boards and modules. Dedicated to providing cost-effective, high performance motion systems to OEM customers, PMD utilizes extensive in-house expertise to minimize time-to-market and maximize customer satisfaction.

ATLAS, ION, Juno, Magellan, Navigator, Pilot, Prodigy, C-Motion and Pro-Motion are trademarks of Performance Motion Devices, Inc. All other trade names, brand names and company names are the property of their respective owners. 2021 Performance Motion Devices, Inc.

X-ON Electronics

Largest Supplier of Electrical and Electronic Components

Click to view similar products for [Motor/Motion/Ignition Controllers & Drivers](#) category:

Click to view products by [Performance Motion Devices](#) manufacturer:

Other Similar products are found below :

[FSB50550TB2](#) [FSBF15CH60BTH](#) [MSVGW45-14-2](#) [MSVGW54-14-3](#) [MSVGW54-14-5](#) [NTE7043](#) [LA6565VR-TLM-E](#) [LB11650-E](#)
[LB1837M-TLM-E](#) [LB1845DAZ-XE](#) [LC898300XA-MH](#) [SS30-TE-L-E](#) [26700](#) [LV8281VR-TLM-H](#) [BA5839FP-E2](#) [IRAM236-1067A](#)
[LA6584JA-AH](#) [LB11847L-E](#) [NCV70501DW002R2G](#) [STK672-630CN-E](#) [TND315S-TL-2H](#) [FNA23060](#) [FSB50250AB](#) [FNA41060](#) [MSVB54](#)
[MSVBTC50E](#) [MSVCPM4-63-12](#) [MSVTA120](#) [FSB50550AB](#) [NCV70501DW002G](#) [LC898301XA-MH](#) [LV8413GP-TE-L-E](#) [MSVGW45-14-3](#)
[MSVGW45-14-4](#) [MSVGW45-14-5](#) [MSVGW54-14-4](#) [STK984-091A-E](#) [SLA7026M](#) [LB11651-E](#) [IRSM515-025DA4](#) [LV8127T-TLM-H](#)
[NCP81382MNTXG](#) [TDA21801](#) [LB11851FA-BH](#) [NCV70627DQ001R2G](#) [LB1938FAGEVB](#) [IGCM04G60GAXKMA1](#) [IKCM15H60HA](#)
[TB6569FTG,8,EL](#) [IGCM04F60HAXKMA1](#)