

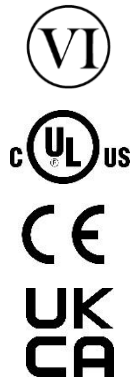

24W Desktop C14 Adapter Series



Features

- DOE Level VI Efficiency Compliant
- EU CoC Tier 2 Compliant (except 5V, 5.9V, 10V, 11V models)
- Over Voltage, Short Circuit and Over Current Protection
- Non-Vented/Spill-Proof Case
- Class B EMI

Applications

- Networking
- Peripherals
- Consumer Electronics



PPL24U Series Specifications¹

Model		PPL24U-480
Output	DC Output Voltage	48.0V
	Max Current	0.5A
	Output Power	24.0W
	Regulation	± 5%
	Ripple & Noise P-P(max) ²	480mV
Input	AC Input Voltage Range	90 to 264VAC
	AC Input Frequency	47 to 63Hz
	Input Current	0.58A max
	Inrush Current	50A max., 100VAC; 60A max., 230VAC
	No Load Power Consumption at 115VAC Input	0.05W
	No Load Power Consumption at 230VAC Input	0.07W
	115VAC Average Efficiency ³	89.3%
	230VAC Average Efficiency ³	88.0%
	230VAC 10% Load Efficiency ³	77.3%
	Leakage Current	<3.5A
Protection	Over-Voltage	75V max
	Short Circuit	Auto-recover after short-circuit fault is removed
	Over-Current	1.2A max
Environmental	Operating Temperature	0°C to +40°C
	Non-Operating Temperature	-20° to +80°C
	Operating Humidity	20 to +80%
Safety Approvals and EMC	Dielectric Withstand (HI-POT)	Primary to Secondary: 3000VAC for 1min, 10mA
	Insulation Resistance	Primary to Secondary: 10M ohm for 500VDC
	Standards	cULus 62368-1, IEC 62368-1
	EMI Emissions	FCC Part 15 Class B, CAN ICES-003(B)/NMB-003(B), EN 55032/CISPR 32 Class B Conducted and Radiated
	Harmonic Current Emissions	IEC 61000-3-2
	Voltage Fluctuations & Flicker	IEC 61000-3-3
	Immunity	EN 55024/CISPR 24: IEC 61000-4-2, IEC 61000-4-3, IEC 61000-4-4, IEC 61000-4-5, IEC 61000-4-6, IEC 61000-4-8, IEC 61000-4-11
Mechanical	Dimensions (L x W x H)	100mm (3.94in) x 50mm (1.97in) x 33mm (1.3in)
	Weight	170g
	Cable Length	1500mm
	DC Cable Type	22 AWG
	DC Output Connector	2.1mm x 5.5mm x 10.0mm
	DC Plug Pin Assignment	Inner (V+) / Outer GND (V-)
	Input Connector	IEC 60320 C14
Notes	<ol style="list-style-type: none"> The specifications defined are at ambient temperature of 25C, unless otherwise specified. 20MHz bandwidth frequency oscilloscope, add a 0.1µF multilayer Cap. and Low ESR Electrolytic Cap. (10µF) at output connector terminals (nominal line voltage, full load). Efficiency is measured after 30 minutes burn-in. 	



PPL24U Outline Drawing

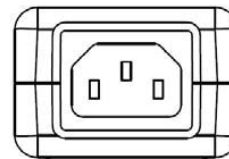
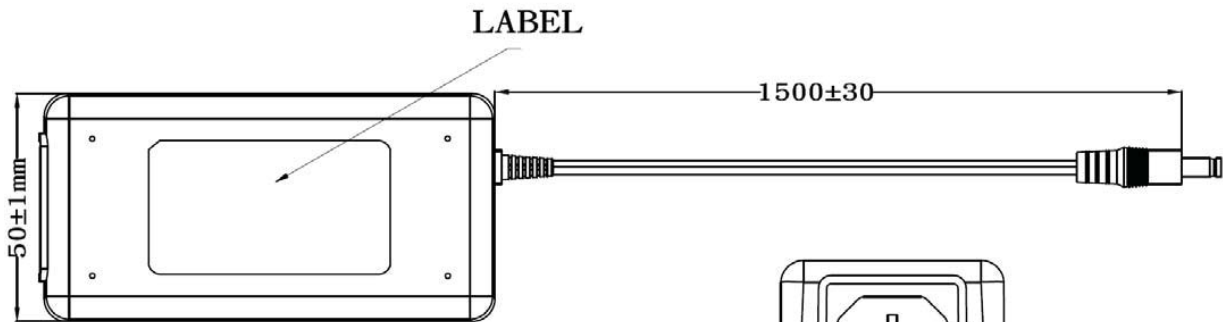
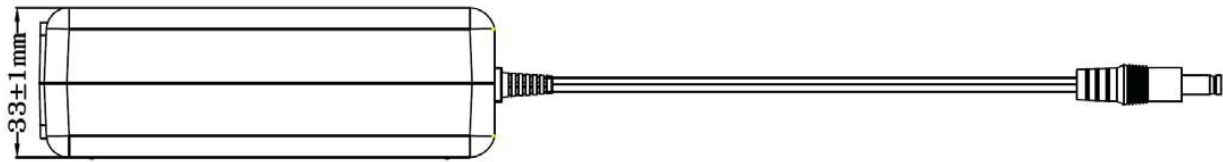
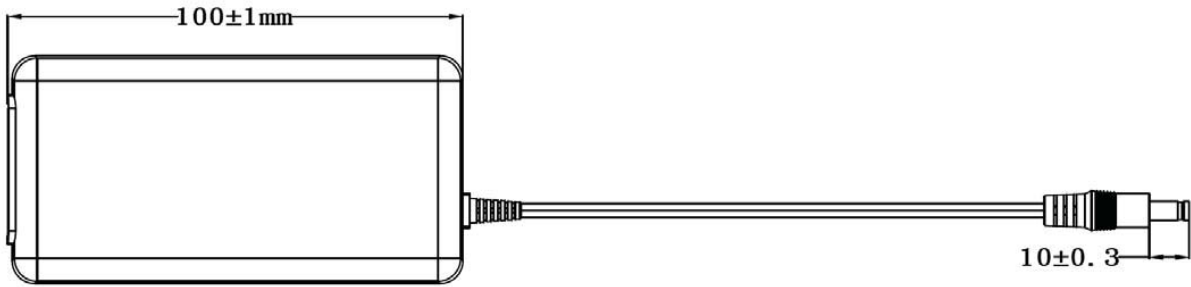





**Supplier's Declaration of Conformity
47 CFR § 2.1077 Compliance Information**

Phihong USA Corporation
47800 Fremont Boulevard
Fremont, CA 94538
Telephone: (510) 445-0100
www.phihong.com

This device complies with/The devices in this product series comply with part 15 of the FCC Rules. Operation is subject to the following two conditions: (1) This device may not cause harmful interference, and (2) this device must accept any interference received, including interference that may cause undesired operation.



Line Cords Sold Separately

Model		AC30UNA-R	AC30UEU-R	AC30UUK-R
Specifications	Plug Type	North America NEMA 5-15P	Continental Europe CEE 7VIII	United Kingdom BS 1363
	Connector	IEC320 C13	IEC320 C13	IEC320 C13
	Wire Size	18 AWG	0.75mm	1.0mm
	Temperature	60°C	70°C	70 °C
	Amperage Rating	10A	6A	10A
	Voltage Rating	125V	250V	250V
	Cable Length	1830mm	1830mm	2500mm
Safety Approvals		CSA; UL	CEBEC; DEMKO; DVE; FIMKO; GOST; IMQ; KEMA; NEMKO; NF; OVE; SEMKO	BSI; Safety Mark
Photos				



Line Cords Outline Drawings

AC30UNA-R

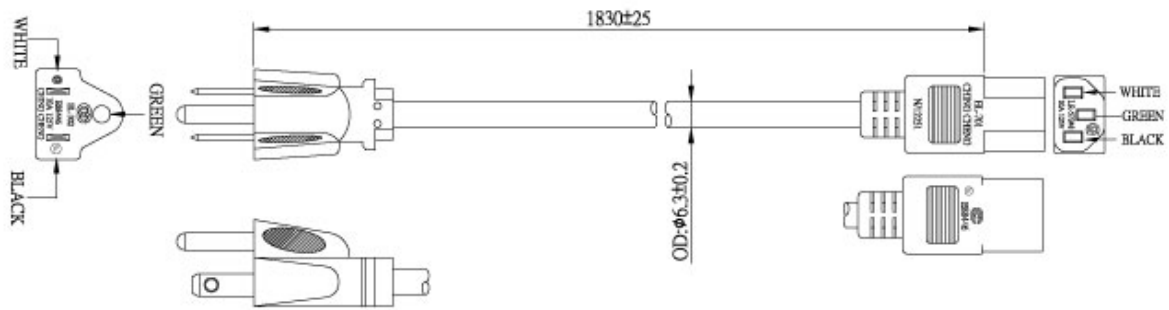

AC30UEU-R

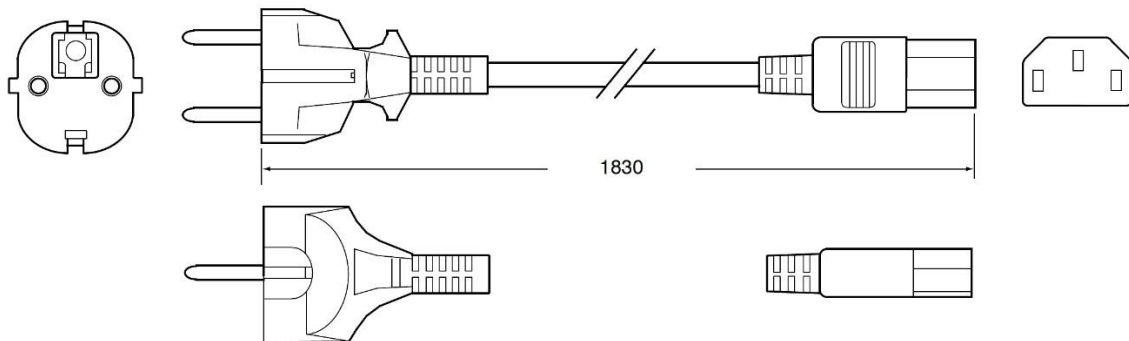

AC30UUK-R

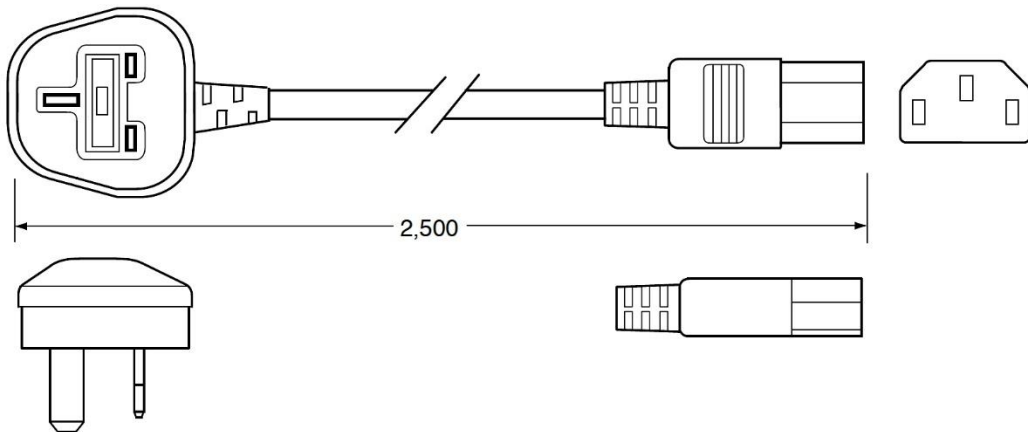

X-ON Electronics

Largest Supplier of Electrical and Electronic Components

Click to view similar products for [Desktop AC Adapters](#) category:

Click to view products by [Phihong](#) manufacturer:

Other Similar products are found below :

[212A2136](#) [ADP485-01](#) [SWA-1202](#) [SWA-1501](#) [212A2220](#) [KR8-PS01](#) [1894875](#) [FWE050024B-10A](#) [820A4080G](#) [825A0057-03](#) [SWA-1704W](#) [AD5012N2LM-\(401\)](#) [TRH21A120-49E03-Level-VI](#) [FWC100024A-11A](#) [FWE050012B-10A](#) [AC-DC ADAPTER 90W w/ Cable](#) [FWA065024A-11A](#) [PSA120U-560L6](#) [96PSA-A63W18V1-M](#) [1895235](#) [PW-C0725-W2-B](#) [57-U1](#) [57-U2](#) [SED80N2-16.0](#) [SED80N3-16.0](#) [RFQ43442-01](#) [YS50-1903150](#) [50966124050E](#) [MEA-045AA2C K-A](#) [PCM50UT04](#) [PCM50UT05](#) [CPSUNOTAKY-07056](#) [CPSUNOTAKY-07168](#) [CPSUNOTAKY-07169](#) [CPSUNOTAKY-07234](#) [CPSUNOTAKY-07236](#) [CPSUNOTAKY-07288](#) [CPSUNOTAKY-07312](#) [CPSUNOTAKY-07342](#) [CPSUNOTAKY-07388](#) [TE30A0503F01](#) [TE30A4803F01](#) [TE40A2403F01](#) [TE40A2403N01](#) [ME30A1803N01](#) [ME30A4803F01](#) [ME40A1203N01](#) [ME40A2403N01](#) [MENT1150A2451F01](#) [125530040F](#)