

PHILIPS

LED Transformers

Datasheet

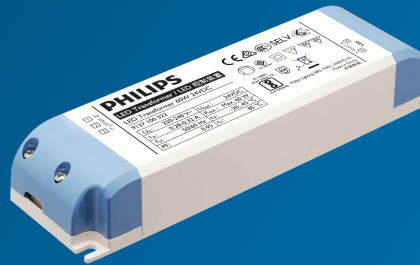

LED Transformers

LED Transformer 60W 24V 220-240V

Product description

Philips full-electronic constant voltage LED Transformers are designed to operate 24VDC LED solutions used in general applications such as refrigerated display lighting, retail display lighting and linear accent lighting. They are specifically designed to ensure the highest performance with maximum robustness combined with a long lifetime.

Benefits

- SELV operating voltages, ensuring safety even if wiring or LED boards become damaged
- Energy savings through high efficiency
- Ultimate robustness, offering peace of mind and lower maintenance costs
- Easy to design-in and install
- Long lifetime

Features

- Independent use for Insulation Class II application
- Global approbations and certifications
- Stable output voltage
- Wide ambient temperature range
- Protection against overpower and overvoltage
- Output short-circuit shutdown feature with automatic restart

Applications

- Retail display lighting, linear accent lighting and refrigerated display lighting
- Shelf lighting
 - Cove lighting
 - Facade accent lighting
 - Coolers and freezers

Electrical input data

Specification item	Value	Unit	Condition
Rated input voltage range	220 ... 240	Vac	Performance
Rated input voltage range	198 ... 264	Vac	Operational safety
Rated input frequency	50 ... 60	Hz	Performance
Rated input frequency	45 ... 66	Hz	Operational safety
Rated input current	0.30	A	230Vac, @ rated output power
Rated input power	70	W	230Vac, @ rated output power
Power factor	0.98		230Vac, @ rated output power.
Total harmonic distortion	5	%	230Vac, @ rated output power.
Efficiency (typ)	87	%	230Vac, @ rated output power.

Electrical output data

Specification item	Value	Unit	Condition
Regulation method	Constant Voltage		Rated output voltage = 24VDC
Output voltage range	22.8 ... 25.2	Vdc	
Output current range	0.1 ... 2.5	A _{dc}	
Output voltage ripple	< 300	mV _{pp}	
Rated output power	60	W	
Line regulation	< 1	%	
Load regulation	< 3	%	
Turn-on delay	≤ 1	s	
Output voltage rise time	≤ 30	ms	
Hold-up time	≥ 15	ms	

Logistical data

Specification item	Value
Product name	LED Transformer 60W 24V 220-240V
Order code	697013372909000
Logistic code 12NC	9137 100 32267
Pieces per box	20

Wiring & Connections

Specification item	Value	Unit	Condition
Input wire cross-section	0.75 ... 2.5 / 18 ... 14	mm ² / AWG	Solid and stranded wire
Input cable diameter	3.3 ... 8	mm	
Input wire strip length	6 ... 7	mm	
Output wire cross-section	0.5 ... 2.5* / 20 ... 14*	mm ² / AWG	Solid and stranded wire
Output cable diameter	2 ... 5	mm	
Output wire strip length	6 ... 7	mm	
Strain relief screw max. torque	0.5	Nm	
Connector screw max. torque	0.5	Nm	
Maximum output cable length	1.0	m	CISPR15: between driver and LED module



*: Shown values apply to independent application.
For CCC compliance: minimum wire cross section = 0.75mm²

Insulation

Insulation	Mains	LED
Mains		SELV (double)
LED	SELV (double)	

Dimensions and weight

Specification item	Value	Unit	Condition
Length (A1)	180.0	mm	
Width (B1)	52.0	mm	
Height (C1)	30.0	mm	
Fixing hole distance (A2)	170.0	mm	Fixing hole diameter: 4.2 mm
Fixing hole distance (B2)	42	mm	
Weight	290	gram	

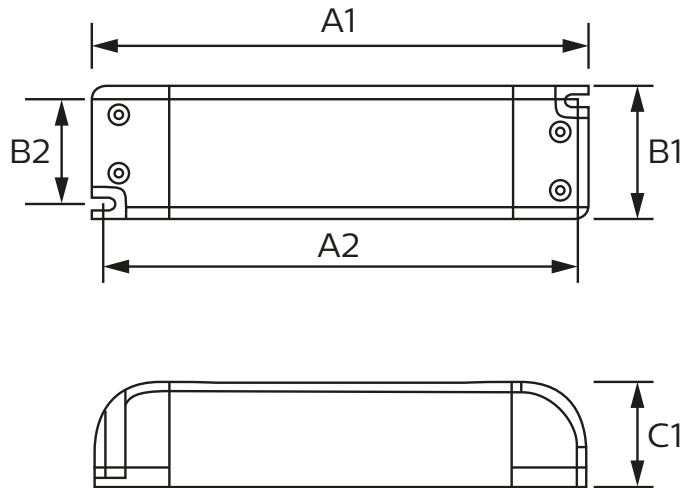

Operational temperatures and humidity

Specification item	Value	Unit	Condition
Driver ambient temperature	-20 ... +45	°C	At rated output power. Higher ambient temperature allowed as long as Tcase-max is not exceeded.
Tcase-min	-20	°C	
Tcase-max	+85	°C	Max. steady-state Tcase
Tcase-life	-20 ... +75	°C	For rated driver lifetime
Maximum housing temperature	110	°C	In case of failure
Relative humidity	10 ... 90	%	Non-condensing
Ingress Protection *	IP20		
Noise and hum	≤ 20	dB	

*: The LED Transformer is primarily intended for independent use. It must not be exposed including but not limited to snow, water and ice or any other chemical agent which may have an adverse affect on driver operation and performance. Exposure may lead to driver failure. It is the luminaire manufacturer's / installer's responsibility to prevent exposure.

Storage temperature and humidity

Specification item	Value	Unit	Condition
Ambient temperature	-20 ... +80	°C	
Relative humidity	5 ... 95	%	Non-condensing

Lifetime

Specification item	Value	Unit	Condition
Rated driver lifetime	50,000	hours	$T_{case} \leq T_{case-life}$. Maximum failures = 10%. See graph.

Features

Specification item	Value	Remark	Condition
Open load protection	Yes		U_{out} (open circuit) = 25.2V max.
Short-circuit protection	Yes		Hiccup mode, automatic recovering
Overpower protection	Yes		Automatic recovering
Overheating protection	No		
Hot wiring	Yes		
Suitable insulation class applications	II		Per IEC60598

Certificates and standards

Specification item	Value
Approval marks	CE / ENEC / CB / F / CCC / RCM / TISI / IS / MM / 110 / Double-insulated / Independent

Inrush current

Specification item	Value	Unit	Condition
Inrush current I_{peak} (typ)	28	A	Input voltage 240Vac
Inrush current T_{width} (typ)	330	μs	Input voltage 240Vac, measured at 50% I_{peak}
Max. recommended number of drivers	13	pcs	MCB 16A B type, mains impedance 200m Ω + 400 μH

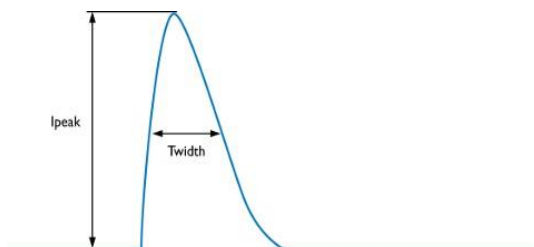

MCB	Rating	Relative number of drivers *
B	6A	37%
B	10A	63%
B	13A	81%
B	16A	100%
B	20A	125%
B	25A	156%
C	6A	63%
C	10A	104%
C	13A	135%
C	16A	170%
C	20A	208%
C	25A	260%
D	6A	125%
D	10A	104%
D	13A	135%
D	16A	170%
D	20A	208%

* : please check that cable cross sectional area corresponds with MCB rating and type

Surge immunity

Specification item	Value	Unit	Condition
Mains surge immunity (diff. mode)	1 / 0.5	kV / kA	L-N, acc. IEC61000-4-5. 2 Ohm, 1.2/50 μs , 8/20 μs

Power factor versus output power

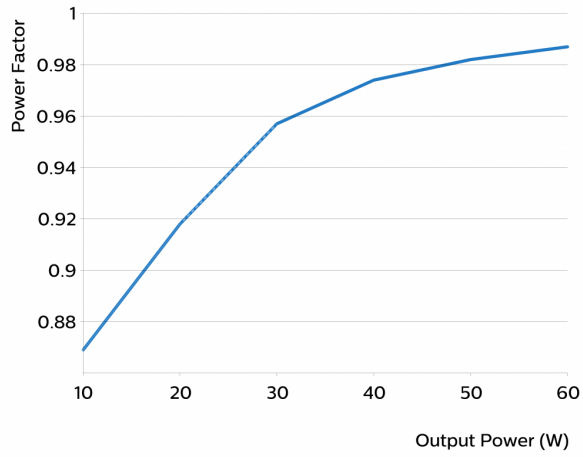

Efficiency versus output power

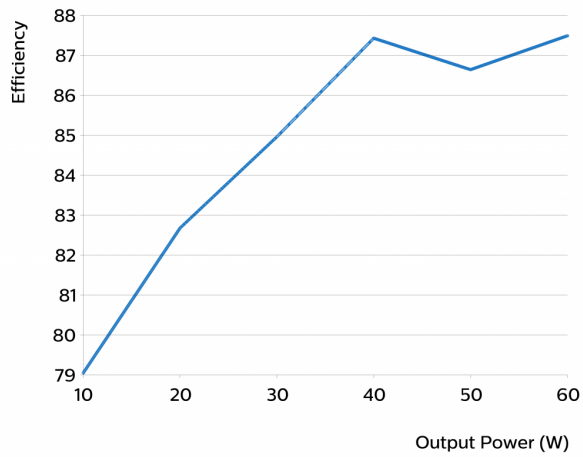

THD versus output power

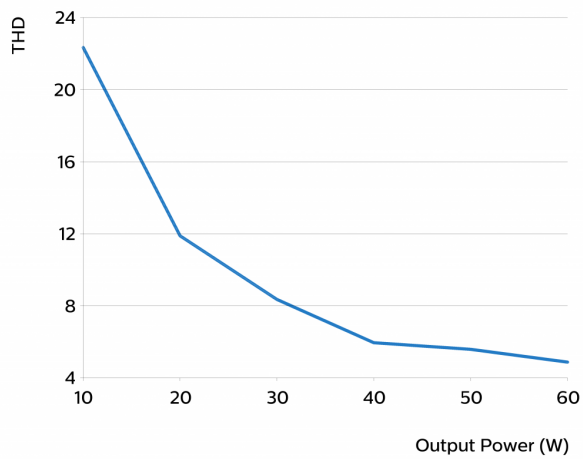

Driver lifetime versus Tc temperature

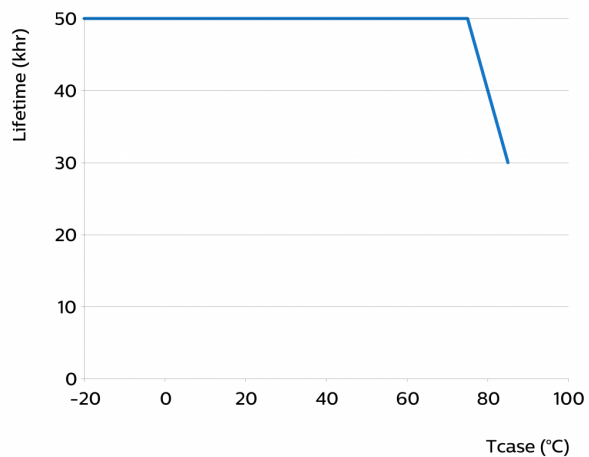

©2021 Signify Holding, IBRS 10461, 5600 VB, NL. All rights reserved.
UK importer address: Signify Commercial UK Limited, 3, Guildford Business Park, GU2 8XG

The information provided herein is subject to change without notice. Signify does not give any representation or warranty as to the accuracy or completeness of the information included herein and shall not be liable for any action in reliance thereon. The information presented in this document is not intended as any commercial offer and does not form part of any quotation or contract, unless otherwise agreed by Signify.

Philips and the Philips Shield Emblem are registered trademarks of Koninklijke Philips N.V. All other trademarks are owned by Signify Holding or their respective owners.
Date of release: March 11, 2021 v3

www.philips.com/oem

X-ON Electronics

Largest Supplier of Electrical and Electronic Components

Click to view similar products for [LED Power Supplies](#) category:

Click to view products by [Philips](#) manufacturer:

Other Similar products are found below :

[PIFC-K250F](#) [PITB-K222A](#) [AC-A60VD24H2.5](#) [ALD-514012PJ134](#) [PWD-60-1-70-P](#) [EUG-200S210DT](#) [ESS030W-1050-21](#) [BPOXL 4-12-035](#) [ESS010W-0180-42](#) [ESS010W-0350-24](#) [ESS010W-0200-42](#) [SLM140W-1.05-130-ZA](#) [ESS015W-0700-18](#) [HVG-240-48AB](#) [HVG-240-54AB](#) [OTE 25/220-240/700 PC](#) [DAL30W-0600-42-T](#) [HVG-320-48AB](#) [CNB30W-0600-42-CAS](#) [87500757](#) [I-SELECT 2 PLUG 2100MA BL](#) [LCU 48V 75W DC-STR FO](#) [LC 45 W 500-1400 MA FLEXC SC EXC](#) [I-SELECT 2 PLUG 2000MA BL](#) [LC 50/200-350/170 FLEXCC LP](#) [SNC3](#) [LCO 14/100-500/38 O4A NF C EXC3](#) [LC 28W 300-700MA 42 FLEXC NF SC EXC3](#) [LC 44/1050/42 FIXC SRL ADV2](#) [LCA 60W 900-1750MA ONE4ALL C PRE](#) [LC 8/180/44 FIXC SR SNC2](#) [LC 19/200-350/54 FLEXC LP SNC4](#) [BXDR-PS-75BS-E116D-01-A](#) [LC 30/500/54 FIXC SR SNC2](#) [LCA 60W 24V ONE4ALL SC PRE SP](#) [LC 60W 75-330MA 310V FLEXC NF H16 EXC4](#) [LC 8/180/42 FIXC PC SR SNC2](#) [LC 10/350/29 FIXC SR SNC2](#) [LC 25/500/43 FIXC SR SNC2](#) [LC 50/100-400/140 PO4A NF H16 PRE3](#) [LC 25/600/42 FIXC SRL ADV2](#) [LCO 24/200-1050/39 NF C ADV3](#) [ELEMENT 35/220...240/900 G3](#) [LC 25W 350-1050MA FLEXC SR EXC](#) [LC 60/700/86 FIXC SR SNC2](#) [LC 35W 24 ONE4ALL IP PRE](#) [BXDR-PS-25BS-E107D-01-A](#) [LC 17W 250-700MA FLEXC SR EXC](#) [LC 15W 350MA FIXC C SNC](#) [LC 14W 700MA FIXC PC SR SNC2](#) [LC 200W 24V SC SNC](#)