

PHILIPS

Xitanium

LED driver



Datasheet

Xitanium FULL Prog LED Xtreme drivers

Xi FP 110W 0.3-1.0A SNLDAE 230V C133 sXt

9290 028 73206

Xitanium FULL Prog LED Xtreme drivers

Philips Xitanium Full Programmable LED drivers are specifically designed to deliver the highest performance, protection and configurability. The portfolio offers both central and standalone dimming protocols further increasing the energy savings and CO₂ reductions achieved with LED lighting. The Xtreme technology ensures maximum robustness and protection combined with a very long lifetime.

In this product family Philips introduces new drivers in a compact form factor with state-of-the-art features, which offer high value for both OEM customers and end-users. The products can replace the existing programmable outdoor LED drivers and will bring significant improvement in programming, assembly into a luminaire and electrical performance.

Benefits

- Ultimate robustness, offering peace of mind and lower maintenance costs
- Fully programmable LED-drivers designed for the new digital and connected lighting world
- Extended diagnostics via MultiOne
- Easy to design-in, configure and install for Class I and Class II applications
- Energy savings through high efficiency and via multiple dimming options

Features

- High surge protection (CM/DM)
- Long lifetime and robust protection against moisture, vibration and temperature
- Configurable operating windows (AOC)
- Multiple control interfaces: DALI, AmpDim, 1-step and 3-step LineSwitch
- Autonomous dimming via integrated DynaDimmer
- Adjustable thermal protection for driver (DTL) and LED module (MTP)
- Constant Light Output (CLO)
- Adjustable Start-up Time (AST)
- Adjustable Light Output (ALO)
- End-Of-Life indicator (EOL)
- Communication through mains via coded commands
- Compliant per DALI Part 251/252/253 (select models)

Application

- Road and street lighting
- Area lighting
- Tunnel lighting
- Industrial lighting

Electrical input data

Specification item	Value	Unit	Condition
Rated input voltage range	202...254	V _{ac}	Performance range
Rated input voltage	230	V _{ac}	
Rated input frequency range	47...63	Hz	Performance range
Rated input current	0.54	A	@ rated output power @ rated input voltage
Max. input current	0.6	A	@ rated output power @ minimum performance input voltage
Rated input power	121	W	@ rated output power @ rated input voltage
Power factor	0.99		@ rated output power @ rated input voltage
Total harmonic distortion	6	%	@ rated output power @ rated input voltage
Efficiency	92.5	%	@ rated output power @ rated input voltage @ max. U _{out}
Rated input voltage DC range	186...250	V _{dc}	Performance range
Rated input current DC range	0.39	A _{dc}	Performance range
Input voltage AC range	80...264	V _{ac}	Safety operational range
Input frequency AC range	45...66	Hz	Safety operational range
Input voltage DC range	168...275	V _{dc}	Safety operational range
Standby Power	0.46	W	
Isolation input to output	Reinforced		

Electrical output data

Specification item	Value	Unit	Condition
Regulation method	Constant Current		
Output voltage	50...160	V _{dc}	
Output voltage max.	230	V	Maximum voltage at open load
Output current	0.07...1.05	A	
Output current min programmable	300	mA	
Output current min dimming	70	mA	
Output current tolerance ±	3	%	
Output current ripple LF	≤ 4	%	Ripple = peak / average < 3kHz
Output current ripple HF	≤ 4	%	
Output P _{st} ^{LM}	≤ 0.07		In entire operating window
Output SVM	≤ 0.07		In entire operating window
Output power	4...110	W	

Electrical data controls input

Specification item	Value	Unit	Condition
Control method	AmpDim, Coded Mains, DALI, Dynadimmer, LineSwitch 3-step, LineSwitch single-step		Output current amplitude dimming. Please refer to design-in guide at www.philips.com/oem for more controllability details.
Dimming range	10...100	%	For latest DALI certification status please visit www.digitalilluminationinterface.org/products ; LineSwitch: Vlow: < 160Vac Vhigh: 170 ... 264Vac
Isolation controls input to output	Reinforced		acc. IEC61347-1

Wiring and Connections

Specification item	Value	Unit	Type
Input wire cross-section	0.5...1.5 / 20...16	mm ² / AWG	solid / stranded wire
Input wire strip length	8.5...9.5	mm	
Output wire cross-section	0.5...1.5 / 20...16	mm ² / AWG	solid / stranded wire
Output wire strip length	8.5...9.5	mm	
Control wire cross-section	0.5...1.5 / 20...16	mm ² / AWG	solid / stranded wire
Control wire strip length	8.5...9.5	mm	
Maximum cable length	0.6	m	CISPR15: between driver and LED module
Maximum NTC output cable length	0.6	m	

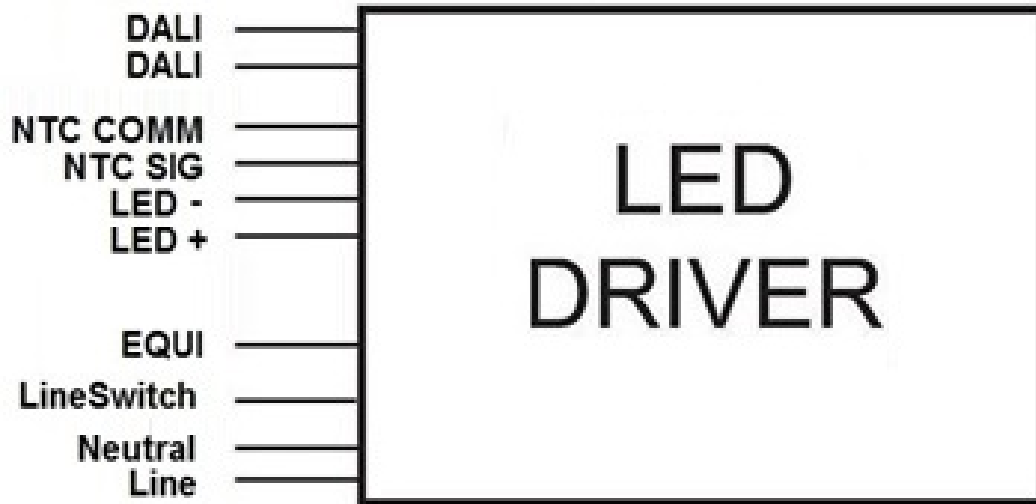

Insulation

Insulation per IEC61347-1	Mains + LineSwitch	EQUI	LED + NTC	DALI
Mains + LineSwitch		Reinforced	Reinforced	Reinforced
EQUI	Reinforced		Basic	Reinforced
LED + NTC	Reinforced	Basic		Reinforced
DALI	Reinforced	Reinforced	Reinforced	

Dimensions and weight

Specification item	Value	Unit	Tolerance (mm)
Length (A1)	133	mm	
Mounting hole distance (A2)	122	mm	
Width (B1)	77	mm	
Height (C1)	39.5	mm	
Mounting hole diameter (D1)	4.2	mm	
Weight	600	gram	

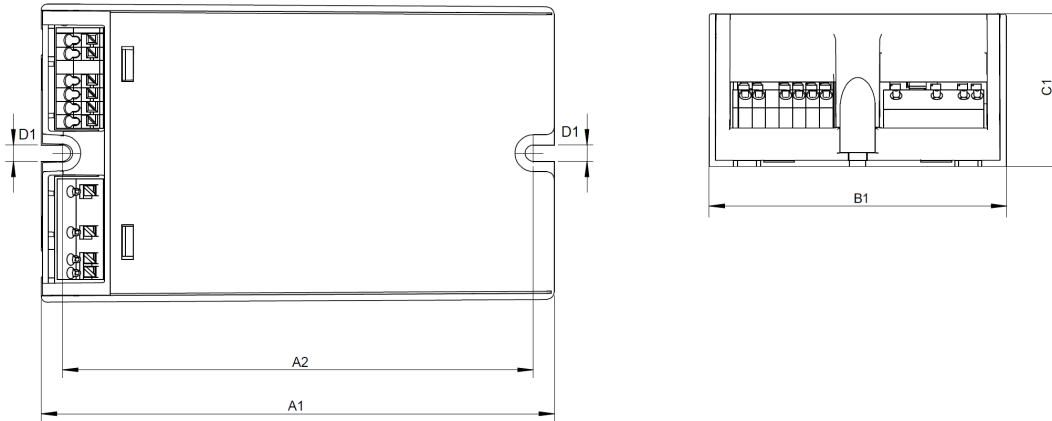

Logistical data

Specification item	Value
Product name	Xi FP 110W 0.3-1.0A SNLDAE 230V C133 sxt
EOC	871951434482200
Logistic code 12NC	9290 028 73206
EAN1 (GTIN)	8719514344822
EAN3 (box)	8719514344839
Pieces per box	12

Operational temperatures and humidity

Specification item	Value	Unit	Condition
Ambient temperature	-40...+55	°C	Higher ambient temperature allowed as long as Tcase-max is not exceeded
Tcase-max	85	°C	Maximum temperature measured at Tcase-point
Tcase-life	75	°C	Measured at Tcase-point
Maximum housing temperature	130	°C	In case of a failure, inherent by design
Relative humidity	10...90	%	Non-condensing

Lifetime

Specification item	Value	Unit	Condition
Driver lifetime	100,000	hours	Measured temperature at Tcase-point is Tcase-life. Maximum failures = 10%



Storage temperature and humidity

Specification item	Value	Unit	Condition
Ambient temperature	-40...+85	°C	
Relative humidity	5...95	%	Non-condensing

Programmable features

Specification item	Available	Default setting	Condition
Set Adjustable Output Current (AOC)	Programmable, SimpleSet	700 mA	
LED Module Temperature Protection (MTP)	Yes	OFF	
Driver Temperature Limit (DTL)	Yes	ON	
Adjustable Light Output (ALO)	Yes	OFF	
Constant Light Output (CLO)	Yes	OFF	
Adjustable Start-up Time (AST)	Yes	1 s	
DALI 253 M	Yes	—	
Integrated Dynadimmer	Yes	OFF	5-step, light turn-off possible
LineSwitch single-step	Yes	ON	
LineSwitch 3-step	Yes	OFF	
AmpDim	Yes	OFF	
Min Dim Level	Yes	10 %	
DC emergency (DCemDim)	Yes	ON	Default: AOC = 15%. EOFx = 10 ... 60%. No external DC rated fuse required. Internal fuse rating: T6.3A 250VAC/DC.
End Of Life indicator (EOL)	Yes	OFF	
Coded Mains	Yes	OFF	
OEM Write Protection (OWP)	Yes	OFF	
Luminaire Info (DALI part 251)	Yes	—	

Features

Specification item	Value	Condition
Open load protection	Yes	Automatic recovering
Short circuit protection	Yes	Automatic recovering
Over power protection	Yes	Automatic recovering
Hot wiring	No	
Suitable for fixtures with protection class	I and II	per IEC60598
Overtemperature protection	Yes	Automatic recovering
Output Overvoltage Detection	Yes	
Energy metering (DALI part 252)	Yes	Accuracy = 10%
Diagnostics	Yes	
Diagnostics (DALI part 253)	Yes	

Inrush current

Specification item	Value	Unit	Condition
Inrush current	47/250	A/ μ s	Input voltage 230V
Drivers / MCB 16A type B	≤ 10	pcs	Indicative value

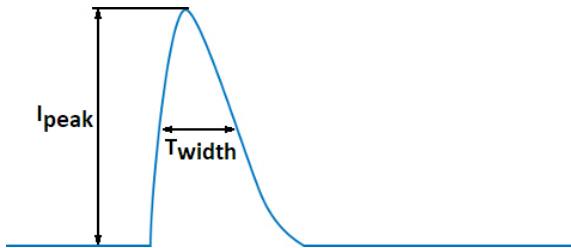

Please refer to the driver design in guide if you use other MCB-types.

Driver touch current / protective conductor current

Specification item	Value	Unit	Condition
Typical Touch Current (ins. Class II)	0.24	mA peak	Acc. IEC61347-1. LED module contribution not included
Typical Protective Conductor Current (ins. Class I)	0.17	mA rms	Acc. IEC60598-1. LED module contribution not included

Surge immunity

Specification item	Value	Unit	Condition
Mains surge immunity (diff. mode)	6	kV	L-N, Ls-L, Ls-N, acc. IEC61000-4-5. 2 Ohm, 1.2/50us, 8/20us
Mains surge immunity (comm. mode)	10	kV	L/N/Ls - EQUI 10kV acc. EN61547; 8kV acc. IEC61000-4-5, 12 Ohm 1.2/50us,8/20us
Control surge immunity (diff. mode)	0.9	kV	DALI - DALI acc. IEC61000-4-5. 2 Ohm, 1.2/50us, 8/20us
Control surge immunity (comm. mode)	6	kV	DALI - EQUI acc. IEC61000-4-5. 12 Ohm, 1.2/50us, 8/20us
Control surge immunity (comm. mode)	8	kV	DALI - L/N/Ls acc. IEC61000-4-5. 12 Ohm, 1.2/50us, 8/20us

Application Info

Specification item	Value
Approval marks	CCC / CE / DALI 2 / Double-insulated Built-In / EAC / EL / ENEC / UA / UKCA / WEEE
Ingress Protection classification (IP)	20
Application	Outdoor
Mounting Type	Built-in

Graphs

Operating window

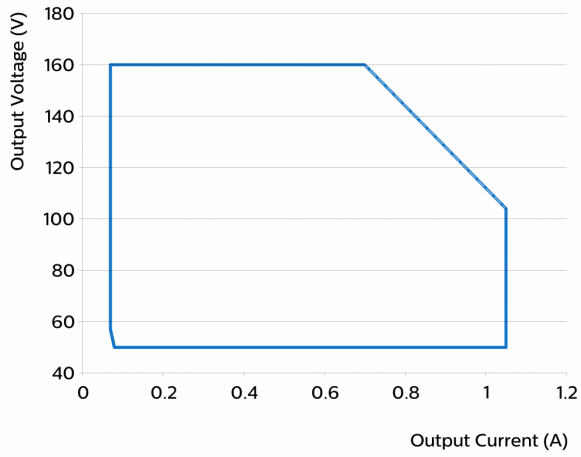

Thermal Guard

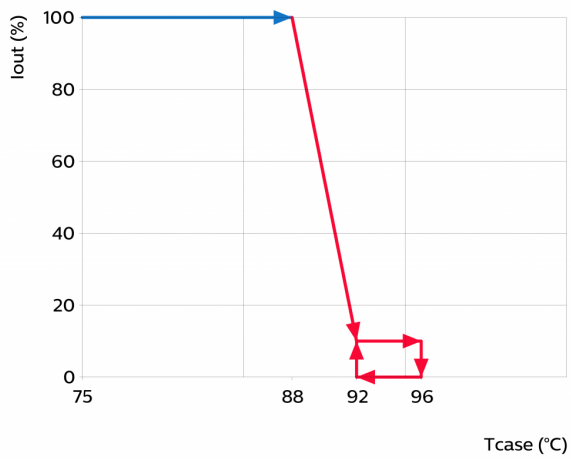

Mains Guard

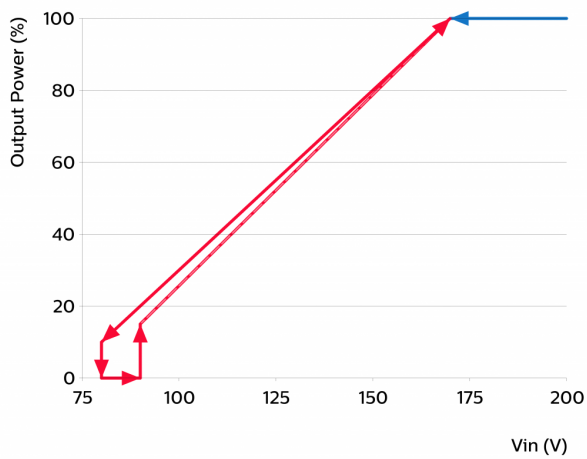

Power factor versus output power

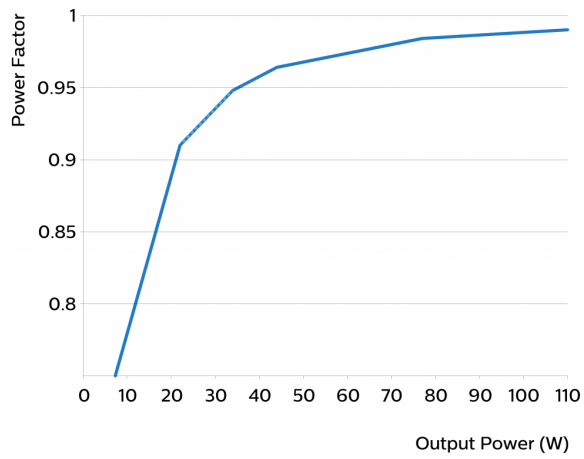

Efficiency versus output power

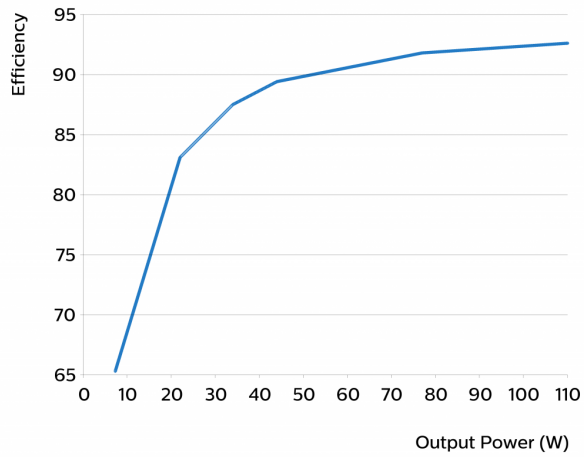

THD versus output power

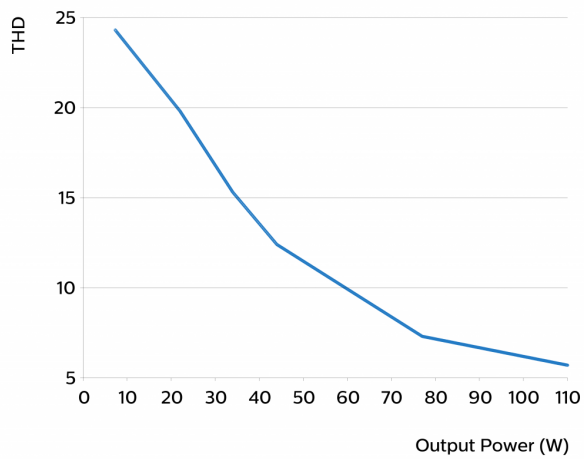



©2021 Signify Holding, IBRS 10461, 5600 VB, NL. All rights reserved.
UK importer address: Signify Commercial UK Limited, 3, Guildford Business Park, GU2 8XG.

The information provided herein is subject to change without notice. Signify does not give any representation or warranty as to the accuracy or completeness of the information included herein and shall not be liable for any action in reliance thereon. The information presented in this document is not intended as any commercial offer and does not form part of any quotation or contract, unless otherwise agreed by Signify.

Philips and the Philips Shield Emblem are registered trademarks of Koninklijke Philips N.V. All other trademarks are owned by Signify Holding or their respective owners.

Date of release: June 17, 2021 v1

www.philips.com/oem

X-ON Electronics

Largest Supplier of Electrical and Electronic Components

Click to view similar products for [LED Power Supplies](#) category:

Click to view products by [Philips](#) manufacturer:

Other Similar products are found below :

[PIFC-K250F](#) [PITB-K222A](#) [AC-A60VD24H2.5](#) [ALD-514012PJ134](#) [PWD-60-1-70-P](#) [ESS030W-1050-21](#) [BPOXL 4-12-035](#) [ESS010W-0180-42](#) [ESS010W-0350-24](#) [ESS010W-0200-42](#) [ESM060W-1400-42](#) [ESS010W-0500-12](#) [SLM140W-1.05-130-ZA](#) [ESS015W-0700-18](#) [HVG-240-54AB](#) [OTE 25/220-240/700 PC](#) [OT FIT 30/220-240/700 CS](#) [DAL30W-0600-42-T](#) [HVG-320-48AB](#) [CNB30W-0600-42-CAS](#) [87500757](#) [I-SELECT 2 PLUG 2100MA BL](#) [LCU 48V 75W DC-STR FO](#) [LC 45 W 500-1400 MA FLEXC SC EXC](#) [I-SELECT 2 PLUG 2000MA BL](#) [LC 50/200-350/170 FLEXCC LP SNC3](#) [LCO 14/100-500/38 O4A NF C EXC3](#) [LC 28W 300-700MA 42 FLEXC NF SC EXC3](#) [LC 44/1050/42 FIXC SRL ADV2](#) [LCA 60W 900-1750MA ONE4ALL C PRE](#) [LC 8/180/44 FIXC SR SNC2](#) [LC 19/200-350/54 FLEXC LP SNC4](#) [BXDR-PS-75BS-E116D-01-A](#) [LC 30/500/54 FIXC SR SNC2](#) [LCA 60W 24V ONE4ALL SC PRE SP](#) [LC 60W 75-330MA 310V FLEXC NF H16 EXC4](#) [LC 8/180/42 FIXC PC SR SNC2](#) [LC 10/350/29 FIXC SR SNC2](#) [LC 25/500/43 FIXC SR SNC2](#) [LC 50/100-400/140 PO4A NF H16 PRE3](#) [LC 25/600/42 FIXC SRL ADV2](#) [LCO 24/200-1050/39 NF C ADV3](#) [ELEMENT 35/220...240/900 G3](#) [LC 25W 350-1050MA FLEXC SR EXC](#) [LC 35W 24 ONE4ALL IP PRE](#) [BXDR-PS-25BS-E107D-01-A](#) [LC 17W 250-700MA FLEXC SR EXC](#) [LC 15W 350MA FIXC C SNC](#) [LC 14W 700MA FIXC PC SR SNC2](#) [LC 200W 24V SC SNC](#)