

# PHILIPS

## Xitanium

### LED driver



## Datasheet

### Xitanium LITE Prog LED Xtreme drivers

Xi LP 110W 0.3-1.0A S1 230V C133 sXt

9290 016 55106

#### Xitanium LITE Prog LED Xtreme drivers

Philips Xitanium Lite Programmable LED drivers are value engineered to deliver a carefully selected feature set and high-end performance, making it a preferred choice for many outdoor applications. The portfolio offers high flexibility with a customizable operating window, enabling differentiation in LED lighting designs via system tuning and being prepared for LED efficacy upgrades.

In this product family Philips offers drivers in both compact as well as stretched form factors with a balanced feature set, which offer high value for both OEM customers and end-users. The products can replace the existing programmable outdoor LED drivers and will bring significant improvement in programming, assembly into a luminaire and electrical performance. One of the key features is SimpleSet<sup>®</sup>, an easy and fast way to configure the driver without the need to power the driver.

#### Benefits

- Ultimate robustness, offering peace of mind and lower maintenance costs
- Balanced configurable feature set covering the most common applications
- Easy to design-in and install for Insulation Class I and Class II applications
- Energy savings through high efficiency and via a choice of dimming options

#### Features

- SimpleSet<sup>®</sup>, wireless configuration interface
- High surge immunity
- Long lifetime and robust protection against moisture, vibration and temperature
- Configurable operating windows (AOC)
- External control interface 1-10V or LineSwitch
- Autonomous dimming via integrated Dynadimmer or Dynadimmer LITE
- Adjustable thermal protection for driver (DTL, select models)
- Adjustable thermal protection for LED module (MTP, select models)
- Simplified linear version of Constant Light Output (CLO LITE)
- DC input voltage operation (select models)

#### Application

- Road and street lighting
- Area lighting
- Tunnel lighting
- Industrial lighting

## Electrical input data

Specification item	Value	Unit	Condition
Rated input voltage range	202...254	V <sub>ac</sub>	Performance range
Rated input voltage	230	V <sub>ac</sub>	
Rated input frequency range	47...63	Hz	Performance range
Rated input current	0.53	A	@ rated output power @ rated input voltage
Max. input current	0.59	A	@ rated output power @ minimum performance input voltage
Rated input power	121	W	@ rated output power @ rated input voltage
Power factor	0.98		@ rated output power @ rated input voltage
Total harmonic distortion	6.5	%	@ rated output power @ rated input voltage
Efficiency	91.5	%	@ rated output power @ rated input voltage @ max. U <sub>out</sub>
Input voltage AC range	80...264	V <sub>ac</sub>	Safety operational range
Input frequency AC range	45...66	Hz	Safety operational range
Isolation input to output	Double		

## Electrical output data

Specification item	Value	Unit	Condition
Regulation method	Constant Current		
Output voltage	50...160	V <sub>dc</sub>	
Output voltage max.	230	V	Maximum voltage at open load
Output current	0.3...1.05	A	
Output current min programmable	300	mA	
Output current min dimming	100	mA	
Output current tolerance ±	5	%	
Output current ripple LF	≤ 4	%	Ripple = peak / average < 3kHz
Output current ripple HF	≤ 4	%	
Output P <sub>st</sub> <sup>LM</sup>	≤ 0.3		In entire operating window
Output SVM	≤ 0.07		In entire operating window
Output power	5...110	W	

## Electrical data controls input

Specification item	Value	Unit	Condition
Control method	1-10V, Dynadimmer		Output current amplitude dimming, 1-10V acc. IEC60929. Please refer to design-in guide at <a href="http://www.philips.com/oem">www.philips.com/oem</a> for more controllability details.
Dimming range	10...100	%	Default curve: 1-8V
Isolation controls input to output	Double		acc. IEC61347-1

## Wiring and Connections

Specification item	Value	Unit	Type
Input wire cross-section	0.5...1.5 / 20...16	mm <sup>2</sup> / AWG	solid / stranded wire
Input wire strip length	8.5...9.5	mm	
Output wire cross-section	0.5...1.5 / 20...16	mm <sup>2</sup> / AWG	solid / stranded wire
Output wire strip length	8.5...9.5	mm	
Control wire cross-section	0.5...1.5 / 20...16	mm <sup>2</sup> / AWG	solid / stranded wire
Control wire strip length	8.5...9.5	mm	
Maximum cable length	1.5	m	CISPR15: between driver and LED module

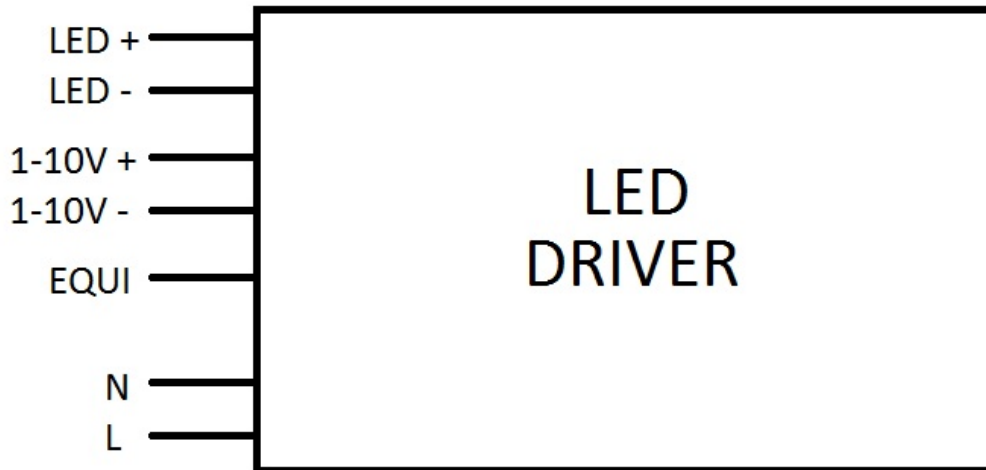

## Insulation

Insulation per IEC61347-1	Mains	EQUI	LED	1-10V
Mains		Double	Double	Basic
EQUI	Double		Basic	Double
LED	Double	Basic		Double
1-10V	Basic	Double	Double	

## Dimensions and weight

Specification item	Value	Unit	Tolerance (mm)
Length (A1)	133	mm	
Mounting hole distance (A2)	122	mm	
Width (B1)	77	mm	
Height (C1)	39.5	mm	
Mounting hole diameter (D1)	4.2	mm	
Weight	570	gram	

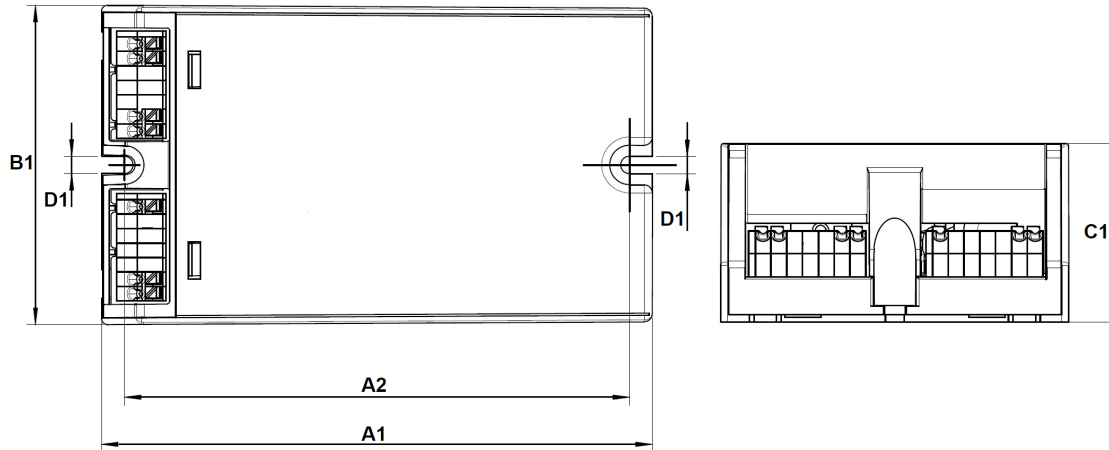

## Logistical data

Specification item	Value
Product name	Xi LP 110W 0.3-1.0A S1 230V C133 sXt
EOC	871869961036400
Logistic code 12NC	9290 016 55106
EAN1 (GTIN)	8718699610364
EAN3 (box)	8718699610371
Pieces per box	12

## Operational temperatures and humidity

Specification item	Value	Unit	Condition
Ambient temperature	-40...+55	°C	Higher ambient temperature allowed as long as T <sub>case-max</sub> is not exceeded
T <sub>case-max</sub>	90	°C	Maximum temperature measured at T <sub>case-point</sub>
T <sub>case-life</sub>	80	°C	Measured at T <sub>case-point</sub>
Maximum housing temperature	130	°C	In case of a failure, inherent by design
Relative humidity	10...90	%	Non-condensing

## Lifetime

Specification item	Value	Unit	Condition
Driver lifetime	100,000	hours	Measured temperature at Tcase-point is Tcase-life. Maximum failures = 10%

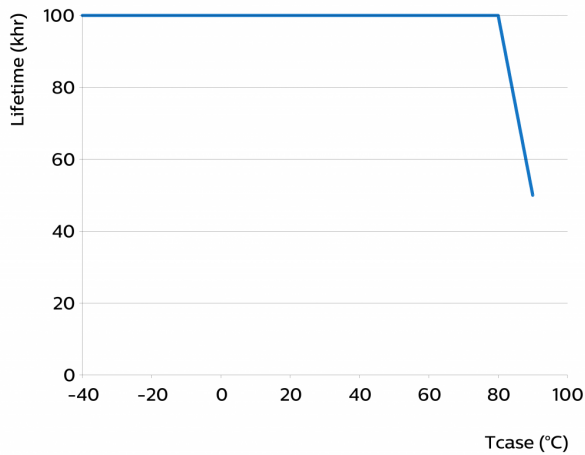

## Storage temperature and humidity

Specification item	Value	Unit	Condition
Ambient temperature	-40...+85	°C	
Relative humidity	5...95	%	Non-condensing

## Programmable features

Specification item	Available	Default setting	Condition
Set Adjustable Output Current (AOC)	SimpleSet	700 mA	
Driver Temperature Limit (DTL)	Yes	ON	
Constant Light Output (CLO) LITE	Yes	OFF	
1-10V	Yes	ON	
Integrated Dynadimmer	Yes	OFF	5-step, no light turn-off possible
Min Dim Level	Yes	10 %	
OEM Write Protection (OWP)	Yes	OFF	

## Features

Specification item	Value	Condition
Open load protection	Yes	Automatic recovering
Short circuit protection	Yes	Automatic recovering
Over power protection	Yes	Automatic recovering
Hot wiring	No	
Suitable for fixtures with protection class	I and II	per IEC60598
Overtemperature protection	Yes	Automatic recovering
Diagnostics	Yes	

## Inrush current

Specification item	Value	Unit	Condition
Inrush current	45/270	A/ $\mu$ s	Input voltage 230V
Drivers / MCB 16A type B	$\leq 10$	pcs	Indicative value

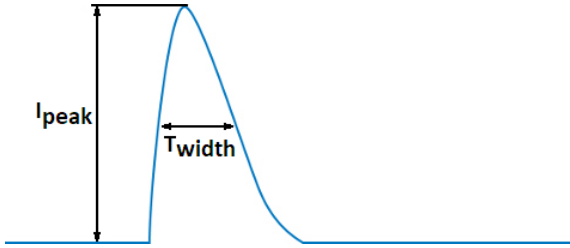

Please refer to the driver design in guide if you use other MCB-types.

## Driver touch current / protective conductor current

Specification item	Value	Unit	Condition
Typical Touch Current (ins. Class II)	0.24	mA peak	Acc. IEC61347-1. LED module contribution not included
Typical Protective Conductor Current (ins. Class I)	0.17	mA rms	Acc. IEC60598-1. LED module contribution not included

## Surge immunity

Specification item	Value	Unit	Condition
Mains surge immunity (diff. mode)	6	kV	L-N acc. IEC61000-4-5. 2 Ohm, 1.2/50us, 8/20us
Mains surge immunity (comm. mode)	10	kV	L/N - EQUI: 10kV acc. EN61547; 8kV acc. IEC61000-4-5, 12 Ohm 1.2/50us,8/20us
Control surge immunity (diff. mode)	0.5	kV	1-10V +/- acc. IEC61000-4-5. 2 Ohm, 1.2/50us, 8/20us
Control surge immunity (comm. mode)	6	kV	L/N - 1-10V acc. IEC61000-4-5. 12 Ohm, 1.2/50us, 8/20us
Control surge immunity (comm. mode)	6	kV	1-10V - EQUI acc. IEC61000-4-5. 12 Ohm, 1.2/50us, 8/20us

## Application Info

Specification item	Value
Approval marks	CCC / CE / Double-insulated Built-In / EAC / ENEC / UA / WEEE
Ingress Protection classification (IP)	20
Application	Outdoor
Mounting Type	Built-in

## Graphs

### Operating window

---

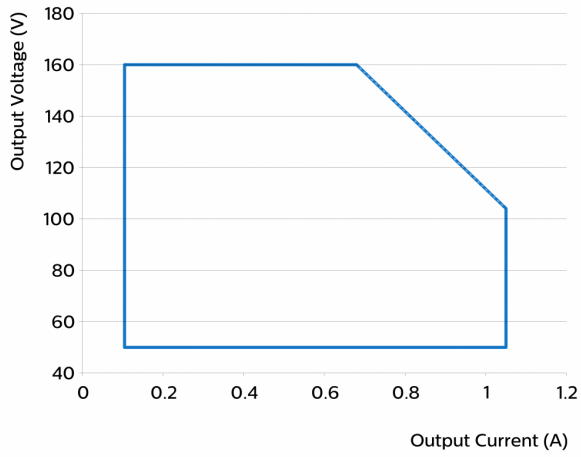

### Thermal Guard

---

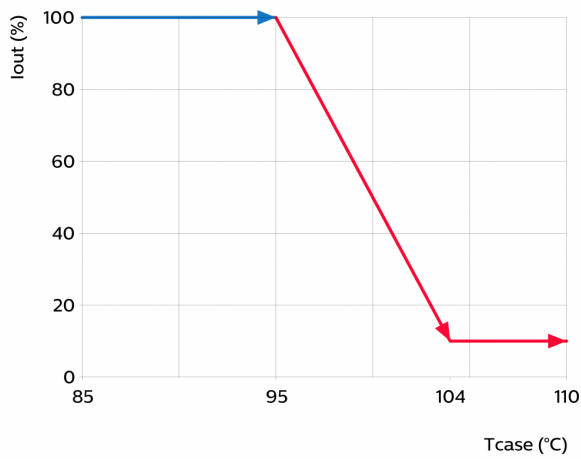

### Mains Guard

---

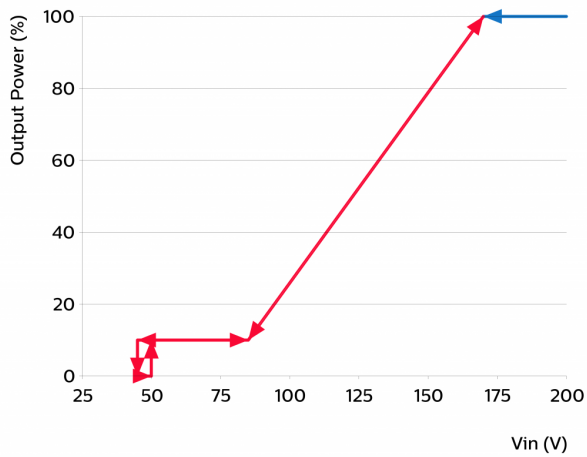

### Power factor versus output power

---

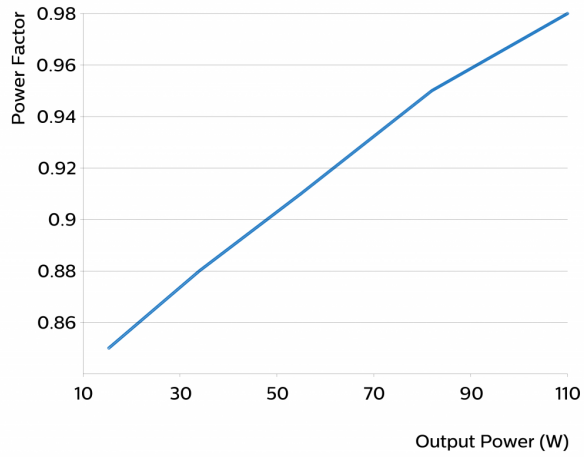

### Efficiency versus output power

---

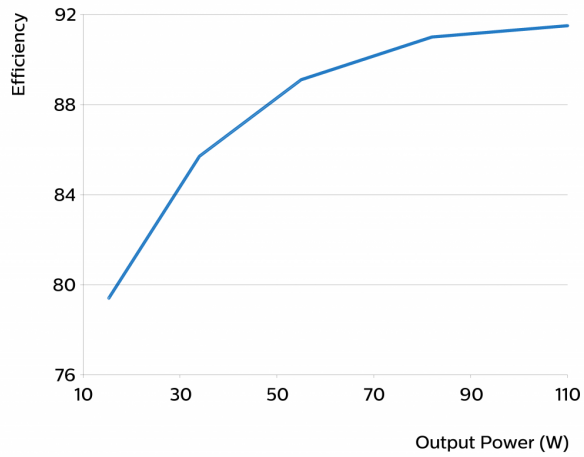

### THD versus output power

---

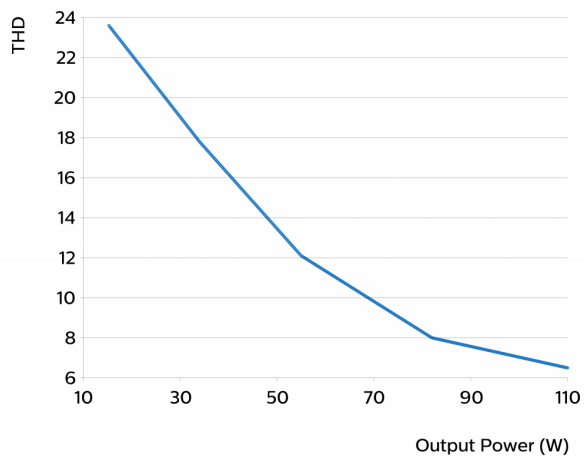





©2021 Signify Holding, IBRS 10461, 5600 VB, NL. All rights reserved.  
UK importer address: Signify Commercial UK Limited, 3, Guildford Business Park, GU2 8XG.

The information provided herein is subject to change without notice. Signify does not give any representation or warranty as to the accuracy or completeness of the information included herein and shall not be liable for any action in reliance thereon. The information presented in this document is not intended as any commercial offer and does not form part of any quotation or contract, unless otherwise agreed by Signify.

Philips and the Philips Shield Emblem are registered trademarks of Koninklijke Philips N.V. All other trademarks are owned by Signify Holding or their respective owners.

Date of release: June 18, 2021 v3

[www.philips.com/oem](http://www.philips.com/oem)

## X-ON Electronics

Largest Supplier of Electrical and Electronic Components

*Click to view similar products for [LED Power Supplies](#) category:*

*Click to view products by [Philips](#) manufacturer:*

Other Similar products are found below :

[PIFC-K250F](#) [PITB-K222A](#) [AC-A60VD24H2.5](#) [ALD-514012PJ134](#) [PWD-60-1-70-P](#) [EUG-200S210DT](#) [ESS030W-1050-21](#) [BPOXL 4-12-035](#) [ESS010W-0180-42](#) [ESS010W-0350-24](#) [ESS010W-0200-42](#) [SLM140W-1.05-130-ZA](#) [ESS015W-0700-18](#) [HVG-240-48AB](#) [HVG-240-54AB](#) [OTE 25/220-240/700 PC](#) [DAL30W-0600-42-T](#) [HVG-320-48AB](#) [CNB30W-0600-42-CAS](#) [87500757](#) [I-SELECT 2 PLUG 2100MA BL](#) [LCU 48V 75W DC-STR FO](#) [LC 45 W 500-1400 MA FLEXC SC EXC](#) [I-SELECT 2 PLUG 2000MA BL](#) [LC 50/200-350/170 FLEXCC LP](#) [SNC3](#) [LCO 14/100-500/38 O4A NF C EXC3](#) [LC 28W 300-700MA 42 FLEXC NF SC EXC3](#) [LC 44/1050/42 FIXC SRL ADV2](#) [LCA 60W 900-1750MA ONE4ALL C PRE](#) [LC 8/180/44 FIXC SR SNC2](#) [LC 19/200-350/54 FLEXC LP SNC4](#) [BXDR-PS-75BS-E116D-01-A](#) [LC 30/500/54 FIXC SR SNC2](#) [LCA 60W 24V ONE4ALL SC PRE SP](#) [LC 60W 75-330MA 310V FLEXC NF H16 EXC4](#) [LC 8/180/42 FIXC PC SR SNC2](#) [LC 10/350/29 FIXC SR SNC2](#) [LC 25/500/43 FIXC SR SNC2](#) [LC 50/100-400/140 PO4A NF H16 PRE3](#) [LC 25/600/42 FIXC SRL ADV2](#) [LCO 24/200-1050/39 NF C ADV3](#) [ELEMENT 35/220...240/900 G3](#) [LC 25W 350-1050MA FLEXC SR EXC](#) [LC 60/700/86 FIXC SR SNC2](#) [LC 35W 24 ONE4ALL IP PRE](#) [BXDR-PS-25BS-E107D-01-A](#) [LC 17W 250-700MA FLEXC SR EXC](#) [LC 15W 350MA FIXC C SNC](#) [LC 14W 700MA FIXC PC SR SNC2](#) [LC 200W 24V SC SNC](#)