

For NEW designs consider
this replacement product:

• LUXEON 3030 HV

LUXEON 3535 HV

High voltage package that reduces
system BOM

LUXEON 3535 HV is a mid power SMD solution available in 24V and 48V configurations. This high voltage architecture allows for freedom of design when an LED project requires less bulky, more efficient drivers and an ultimate cost down on the LED system. Available in a 3535 platform, this product enables interchangeability with other 3535 products and is offered in 1/9th micro-color binning structure.



FEATURES AND BENEFITS

Multiple voltages available for mixing in a system to optimize total voltage output

1/9th micro-color binning enables tight color control

High voltage for lower current, more efficient and cost effective drivers

High light output per package allows for reduced LED count

Excellent current spreading leads to better light extraction

LM-80 report available

PRIMARY APPLICATIONS

Downlights

Lamps

Table of Contents

General Information	2
Product Nomenclature	2
Average Lumen Maintenance Characteristics	2
Environmental Compliance	2
Product Selection	3
Electrical Characteristics	3
Absolute Maximum Ratings	4
JEDEC Moisture Sensitivity	4
Reflow Soldering Characteristics	5
Mechanical Dimensions and Package Information	6
Solder Pad Design	7
Package Information	7
Characteristic Curves	8
Relative Spectral Distribution vs. Wavelength	8
Relative Light Output Characteristics over Junction Temperature	8
Typical Forward Current Characteristics	9
Forward Current vs. Forward Voltage	9
Typical Light Output Characteristics	10
Typical Radiation Patterns	11
Radiation Pattern in Cartesian Coordinate System	11
Radiation Pattern in Polar Coordinate System	11
Emitter Packaging	12
Emitter Reel Packaging	13
Product Binning and Labeling	14
Flux Bin Labeling	14
Flux Bins	15
Forward Voltage Bins	15
Color Bin Structure	16

General Information

Product Nomenclature

LUXEON 3535 HV is tested and binned at $T_j = 25^\circ\text{C}$ with a drive current of 15 mA DC. The part number designation is explained as follows:

L 13 5 - A A B B C D H V 0 0 0 0 1

Where:

- A — designates CCT (2700K = 27)
- B — designates CRI (70, 80 and 90)
- C — designates attribute (0)
- D — designates voltage (A=12V, B=24V, C=48V)

For example, a white LUXEON 3535 HV 4000K/80 CRI 24V emitter has the following part number:

L 13 5 - 4 0 8 0 0 W B H V 0 0 0 0 1

Average Lumen Maintenance Characteristics

The LUXEON 3535 HV is being tested in accordance with LM-80 standards. Please contact your Lumileds TSM or sales person for more detailed information.

Environmental Compliance

Lumileds is committed to providing environmentally friendly products to the solid-state lighting market. LUXEON 3535 HV is compliant to the European Union directives on the restriction of hazardous substances in electronic equipment, namely the RoHS and REACH directives. Lumileds will not intentionally add the following restricted material to the LUXEON 3535 HV L135-XX800XHV00001: lead, mercury, cadmium, hexavalent chromium, polybrominated biphenyls (PBB) or polybrominated diphenyl ethers (PBDE).

Product Selection

Product Selection Guide for LUXEON 3535 HV LEDs Junction Temperature = 25°C

Table 1.

Voltage	Nominal CCT	Part Number	Luminous Flux (lm) ^[1] @ 15 mA		Luminous Flux (lm) ^[1] @ 20 mA	CRI ^[1]	Rth (°C/W)	
			Minimum	Typical	Typical	Minimum	Typical	
24	2700K	L135-27800BHV00001	37	41	53	80	25	
24	3000K	L135-30800BHV00001	39	43	55	80	25	
24	4000K	L135-40800BHV00001	42	48	60	80	25	
24	5000K	L135-50800BHV00001	42	48	60	80	25	
48	2700K	L135-27800CHV00001	71	80	102	80	14	
48	3000K	L135-30800CHV00001	75	84	107	80	14	
48	4000K	L135-40800CHV00001	83	93	120	80	14	
48	5000K	L135-50800CHV00001	83	93	120	80	14	

Notes for Table 1:

1. Lumileds maintains a tolerance of ± 7.5% on luminous flux and ± 2 on CRI measurements.

Electrical Characteristics

Electrical Characteristics for LUXEON 3535 HV LEDs Junction Temperature = 25°C, Test Current = 15 mA

Table 2.

Part Number	Forward Voltage V_f (V)			Temperature Coefficient of Forward Voltage between 25°C and 85°C $\Delta V_f / \Delta T_j$ (mV/°C)
	Minimum	Typical	Maximum	
L135-27800BHV00001 L135-30800BHV00001 L135-40800BHV00001 L135-50800BHV00001	22	24	26	-13
L135-27800CHV00001 L135-30800CHV00001 L135-40800CHV00001 L135-50800CHV00001	44	48	52	-26

Notes for Table 2:

1. Forward voltage test tolerance: ± 0.1 volts.

Absolute Maximum Ratings

Table 3.

Parameter	Maximum Performance
DC Forward Current ^[1]	30 mA
Peak Pulsed Forward Current ^[2]	40 mA
LED Junction Temperature ^[1]	125°C
ESD Sensitivity	< 2000V Human Body Model (HBM) Class 2A JS-001-2012
Operating Case Temperature at 15 mA	-40°C - 105°C
Storage Temperature	-40°C - 105°C
Soldering Temperature	JEDEC 020D 260°C
Allowable Reflow Cycles	3
Reverse Voltage (Vr)	n/a

Notes for Table 3:

1. Ripple current with a frequency of 50-150 Hz is allowed as long as the average of the current waveform is below 30 mA and the maximum of the current waveform is lower than 40mA.
2. At 10% duty cycle and pulse width 10ms.
3. LUXEON 3535 HV LEDs are not designed to be driven in reverse bias.
4. At a maximum reverse current of 10 μ A.

JEDEC Moisture Sensitivity

Table 4.

Level	Floor Life		Soak Requirements Standard	
	Time	Conditions	Time	Conditions
2	1 year	$\leq 30^{\circ}\text{C} / 60\% \text{RH}$	168 Hrs. $\pm 5/0$ Hrs.	$\leq 85^{\circ}\text{C} / 60\% \text{RH}$

Reflow Soldering Characteristics

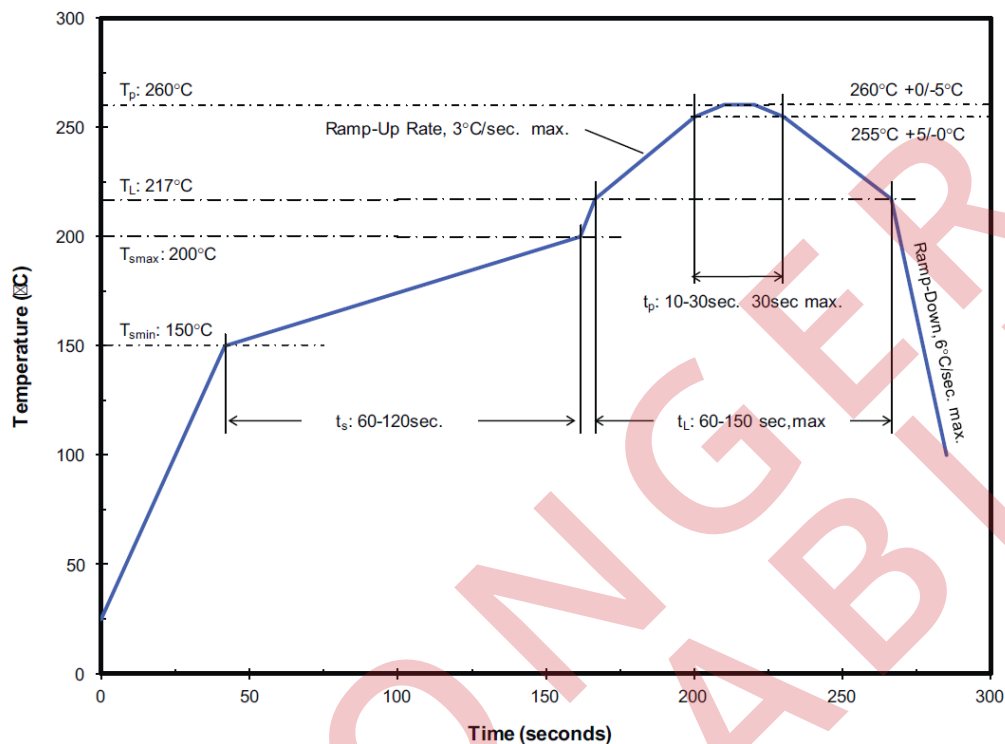

Figure 1. Temperature profile for Table 5.

Table 5. Reflow Profile in Accordance with J-Std-020D

Profile Feature	Lead Free Assembly
Preheat/Soak:	
Temperature Min (T_{smin})	150°C
Temperature Max (T_{smax})	200°C
Maximum Time (t_s) from T_{smin} to T_{smax}	120 seconds
Ramp-up Rate (T_L to T_p)	3°C / second
Liquidous Temperature (T_L)	217°C
Maximum Time (t_L) Maintained T_L	150 seconds
Maximum Peak Package Body Temperature (T_p)	260°C
Time (t_p) within 5°C of the specified temperature (T_c)	10 - 30 seconds
Maximum Ramp-Down Rate (T_p to T_L)	6°C / second
Maximum Time 25°C to Peak Temperature	8 minutes

Notes for Table 5:

1. All temperatures refer to the application Printed Circuit Board (PCB), measured on the surface adjacent to the package body.

Mechanical Dimensions and Package Information

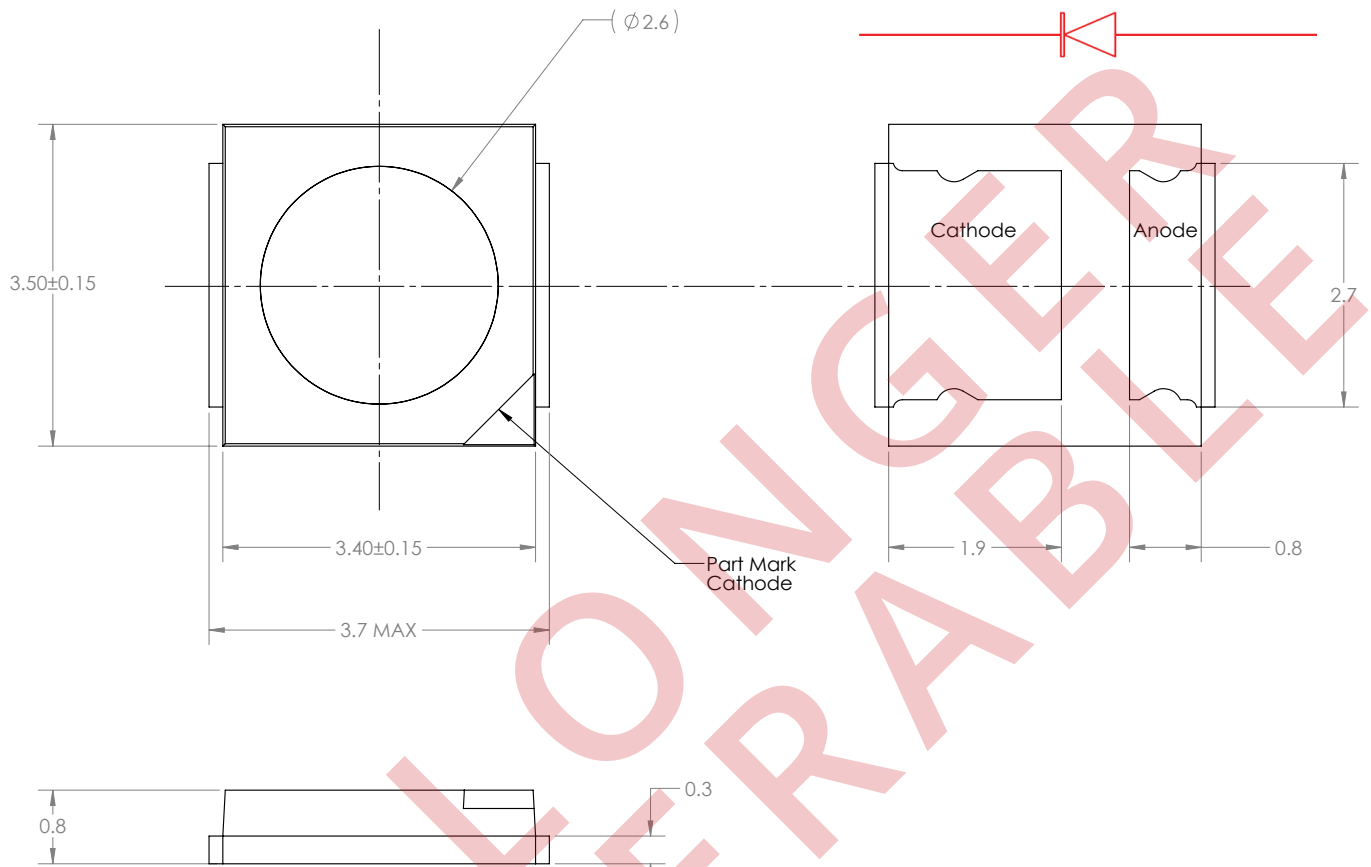

Figure 2.

Notes for Figure 2:

1. All dimensions are in millimeters.
2. Tolerance ± 0.10 mm.

Solder Pad Design

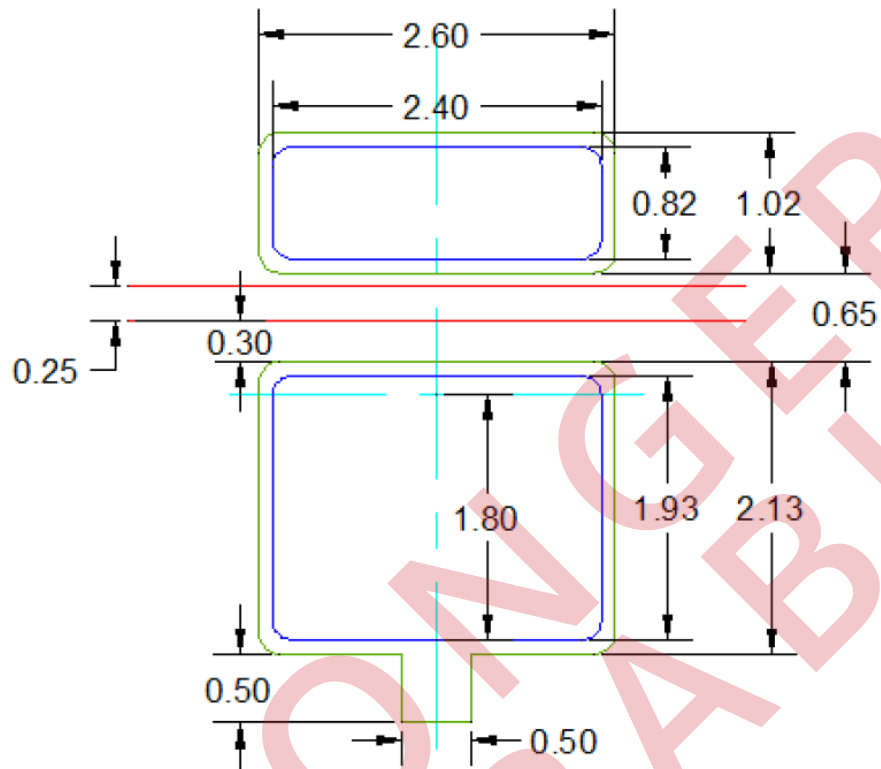

Figure 3. Solder pad layout.

Notes for Figure 3:

1. The drawing above shows the recommend solder pad layout on the Printed Circuit Board (PCB).
2. All dimensions are in millimeters.
3. Application Brief AB203 provides details for this layout. In addition, the drawing files are available at www.lumileds.com.

Package Information

Table 6. Package Information for L135-xx80-0xHV-00001

Material/Component	Specification
Lead Frame Base	Copper Alloy
Package Body	High Temperature Thermal Plastic
Encapsulate	Silicone Resin, with Phosphor
Weight	0.08gram

Characteristic Curves

Relative Spectral Distribution vs. Wavelength

Junction Temperature = 25°C; Test Current = 15 mA

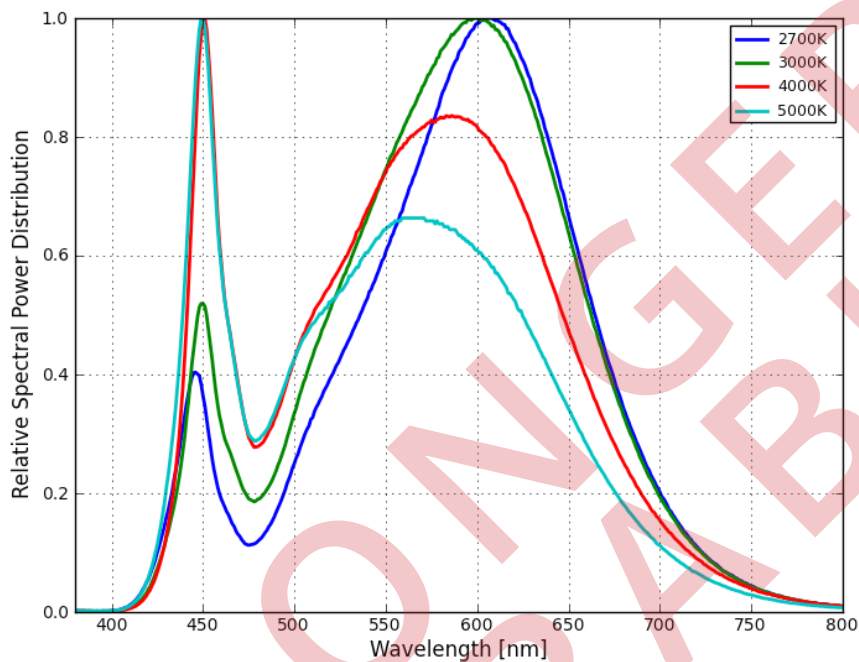

Figure 4. Color spectrum, L135-xx80-0xHV-00001.

Relative Light Output Characteristics over Junction Temperature

Test Current = 15 mA

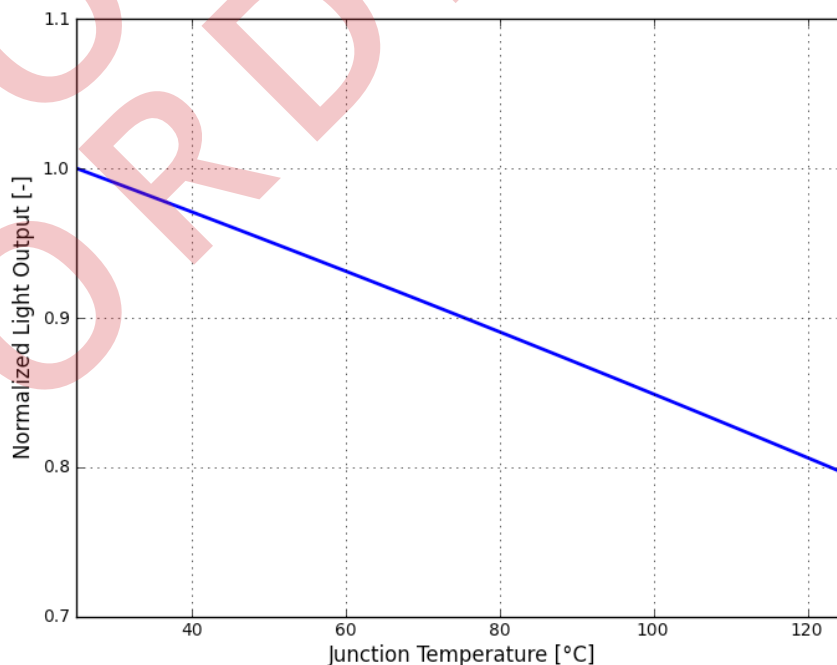

Figure 5. Relative light output vs. junction temperature, L135-xx80-0xHV-00001.

Typical Forward Current Characteristics

Forward Current vs. Forward Voltage for L135-xx80-0BHV-00001
Junction Temperature = 25°C

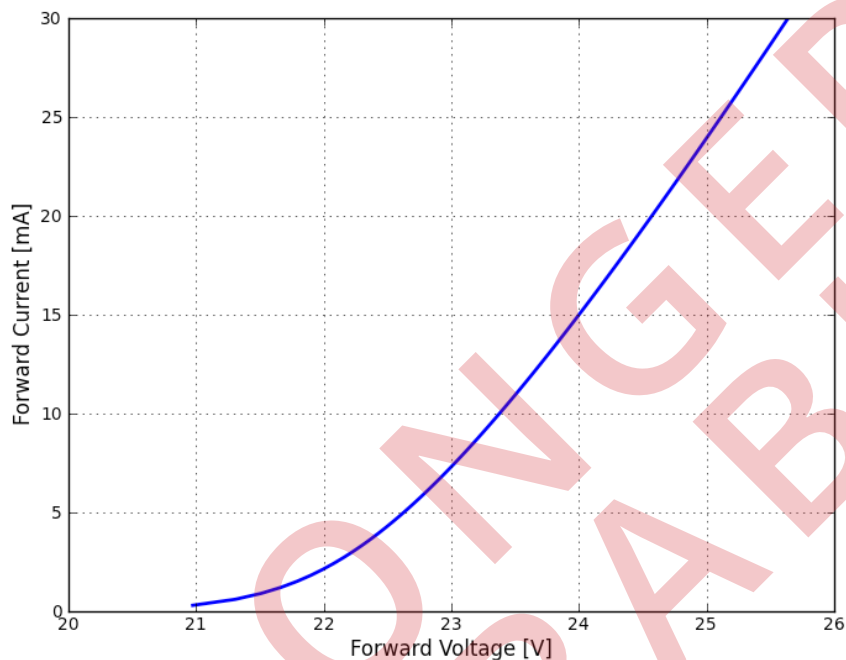

Figure 6. Typical forward current vs. forward voltage, L135-xx80-0BHV-00001.

Forward Current vs. Forward Voltage for L135-xx80-0CHV-00001
Junction Temperature = 25°C

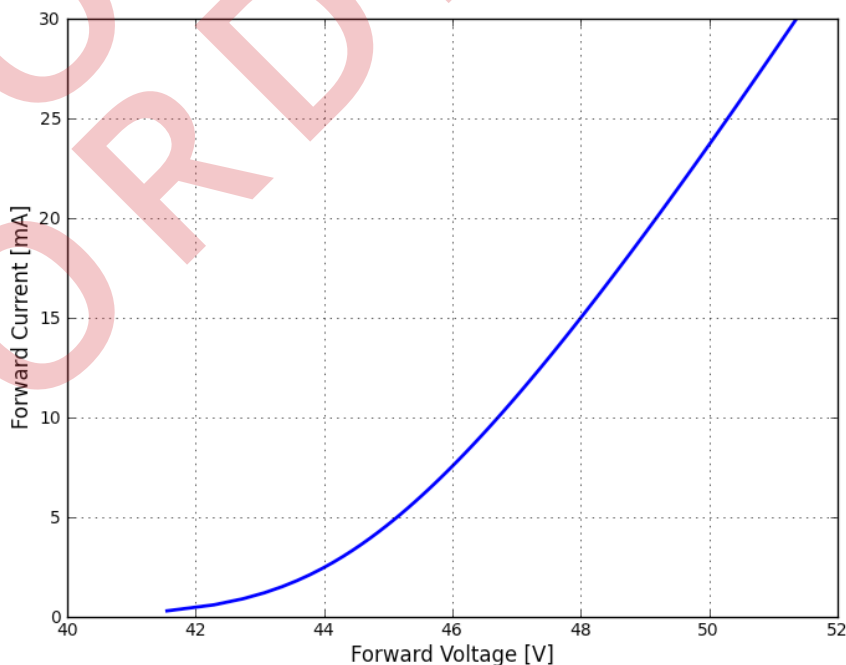

Figure 7. Typical forward current vs. forward voltage, L135-xx80-0CHV-00001.

Typical Light Output Characteristics

Relative Light Output vs. Forward Current
Junction Temperature = 25°C

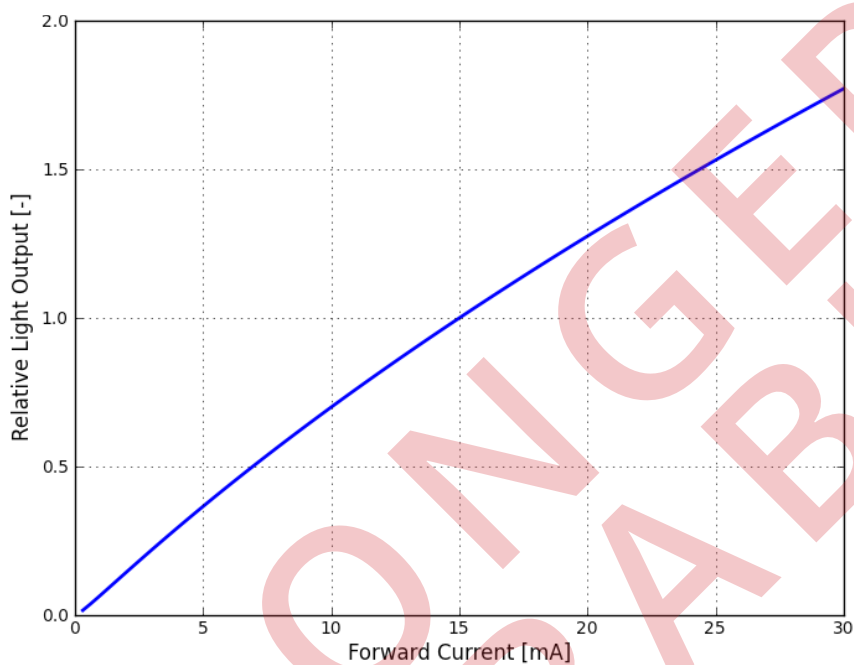

Figure 8. Relative light output vs. forward current, L135-xx80-0xHV-00001.

Typical Radiation Patterns

Radiation Pattern in Cartesian Coordinate System

Junction Temperature = 25°C

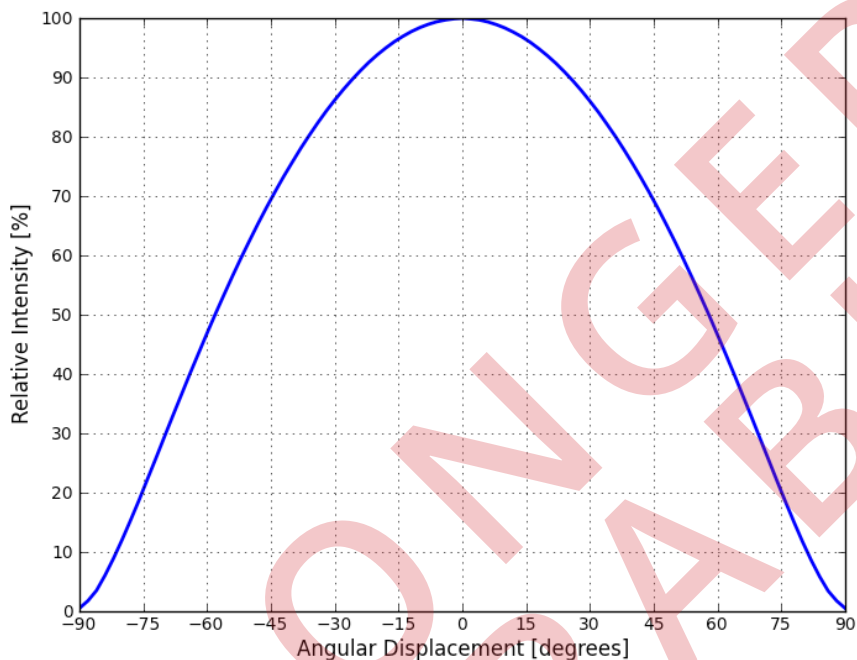

Figure 9. Typical spatial radiation pattern, L135-xx80-0xHV-00001.

Radiation Pattern in Polar Coordinate System

Junction Temperature = 25°C

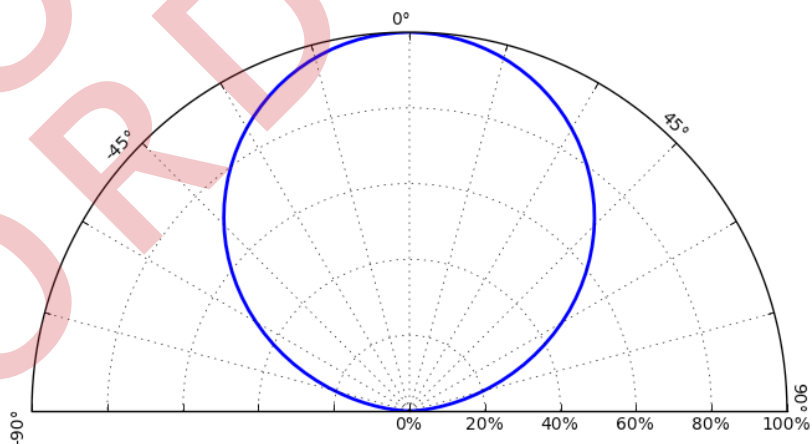

Figure 10. Typical polar radiation pattern, L135-xx80-0xHV-00001.

Emitter Packaging

Emitter Pocket Tape Packaging

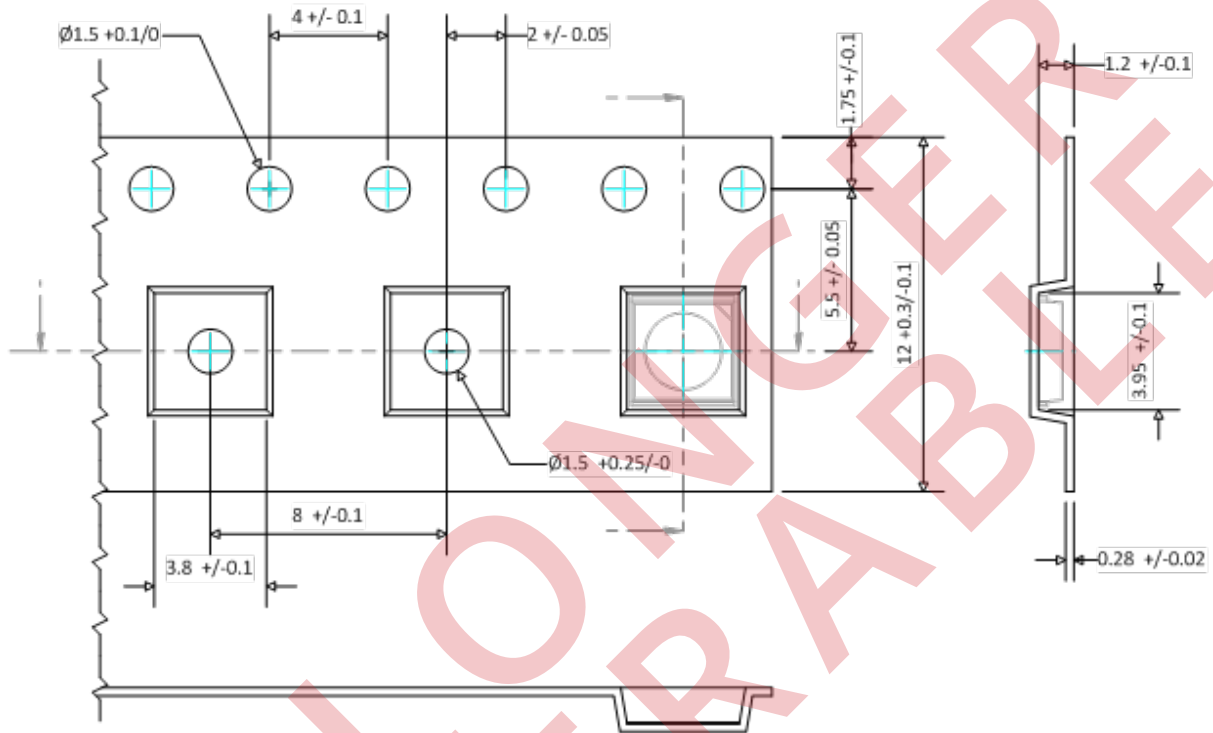

Figure 11. Emitter pocket tape packaging.

Notes for Figure 11:

1. All dimensions are in millimeters.
2. Empty component pockets sealed with top cover tape.
3. The maximum number of consecutive missing LEDs is two.

Emitter Reel Packaging

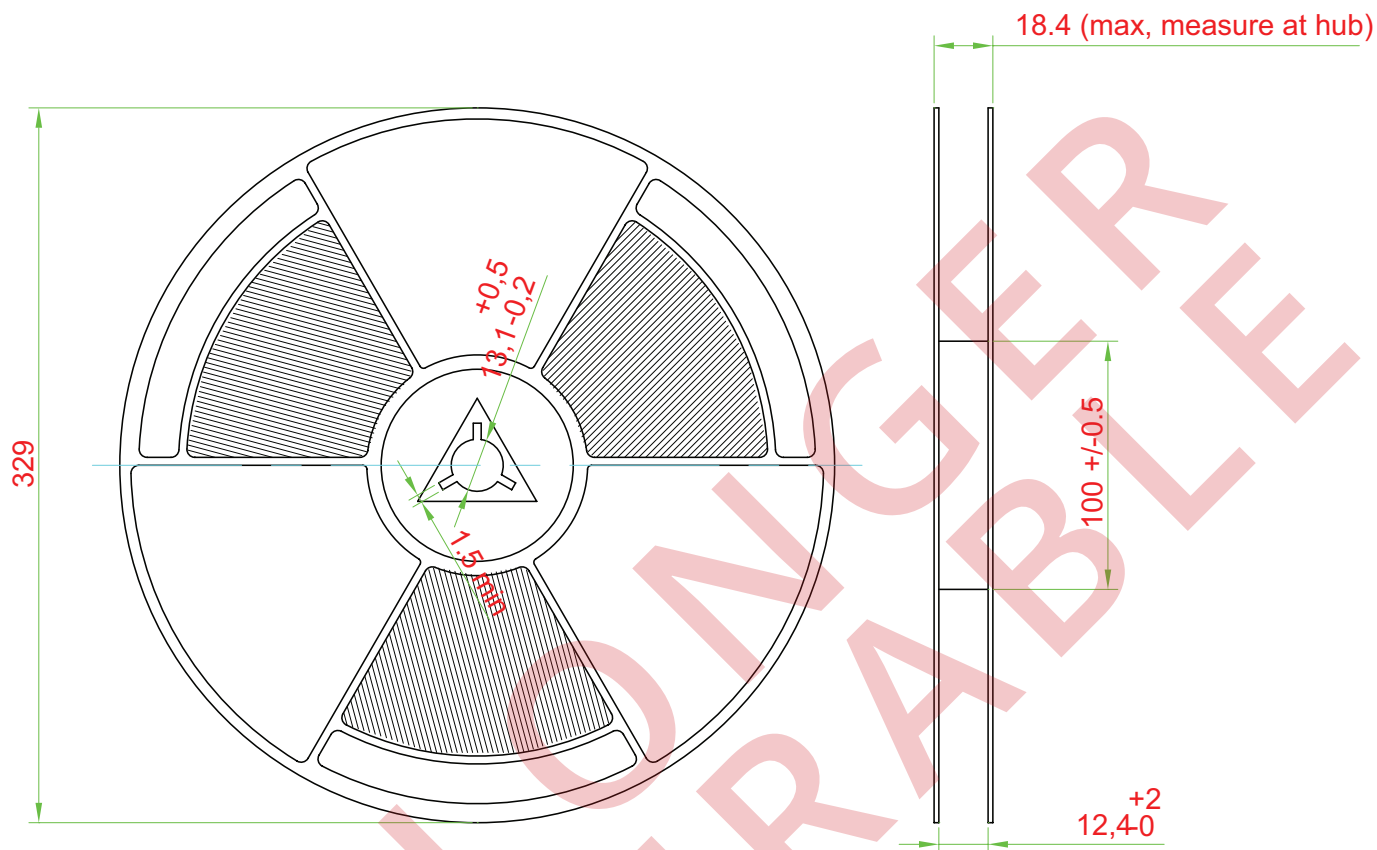

Figure 12. Emitter reel packaging.

Notes for Figure 12:

1. All dimensions are in millimeters.
2. Empty component pockets sealed with top cover tape.
3. 13 inch reel-5000 pieces per reel.
4. Minimum packing quantity is 5000 pieces.
5. The maximum number of consecutive missing LEDs is two.
6. In accordance with EIA-481-1-B specification.

Product Binning and Labeling

Purpose of Product Binning

In the manufacturing of semiconductor products, there is a variation of performance around the average values given in the technical data sheets. For this reason, Lumileds bins the LED components for luminous flux, color and forward voltage (V_f).

Decoding Product Bin Labeling

LUXEON mid-power emitters are labeled using a four digit alphanumeric code (CAT code) depicting the bin values for emitters packaged on a single reel. All emitters packaged within a reel are of the same 3-variable bin combination. Using these codes, it is possible to determine optimum mixing and matching of products for consistency in a given application.

Reels of 2700K, 3000K, 3500K, 4000K, 5000K emitters are labeled with the CAT code following the format below.

ABCD

Where:

- A — Flux bin (L etc.)
- B & C — Color bin (For example 5J, 5D, 5L, 5M)
- D — V_f bin

Luminous Flux Bins

Table 7 and Table 8 list the standard photometric luminous flux bins for LUXEON mid-power emitters (tested and binned at 15 mA). Although several bins are outlined, product availability in a particular bin varies by production run and by product performance. Not all bins are available in all colors. Please contact your Lumileds representative for the L135-xx80-xBHV-00001 & L135-xx80-xCHV-00001 flux bins.

Flux Bin Labeling

Table 7. Flux Bins for L135-xx80-0BHV-00001

Bin Code	Minimum Photometric Flux (lm)	Maximum Photometric Flux (lm)
K	28	32
L	32	36
M	36	40
P	40	44
Q	44	48
R	48	52
S	52	56

Note for Table 7:

1. Tested and binned at 25°C, $I_f = 15$ mA. Tester tolerance: $\pm 7.5\%$.

Flux Bins

Table 8. Flux Bins for L135-xx80-OCHV-00001

Bin Code	Minimum Photometric Flux (lm)	Maximum Photometric Flux (lm)
B	60	65
C	65	70
D	70	75
E	75	80
F	80	85
G	85	90
H	90	95

Note for Table 8:

1. Tested and binned at 25°C, $I_f = 15$ mA. Tester tolerance: $\pm 7.5\%$.

Forward Voltage Bins

Table 9. V_f Bins for L135-xx80-OBHV-00001

Bin Code	Minimum Forward Voltage (V)	Maximum Forward Voltage (V)
F	22.0	22.8
G	22.8	23.6
H	23.6	24.4
I	24.4	25.2
J	25.2	26.0

Note for Table 9:

1. Tested and binned at 25°C, $I_f = 15$ mA. Tester tolerance: $\pm 1.5\%$.

Table 10. V_f Bins for L135-xx80-OCHV-00001

Bin Code	Minimum Forward Voltage (V)	Maximum Forward Voltage (V)
L	44.0	45.6
M	45.6	47.2
P	47.2	48.8
Q	48.8	50.4
R	50.4	52.0

Note for Table 10:

1. Tested and binned at 25°C, $I_f = 15$ mA. Tester tolerance: $\pm 1.5\%$.

Color Bin Structure

L135-2780-0xHV-00001 Color Bin Structure

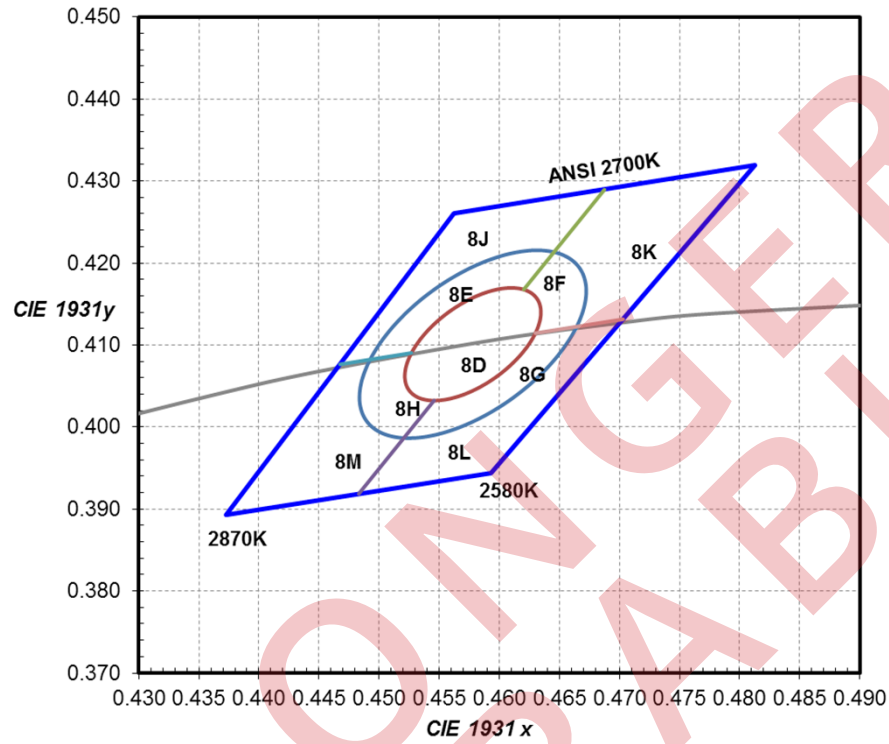

Figure 13. 2700K 1/9th color bin structure.

Table 11.

Nominal ANSI CCT	Color Space	Target Center Point (cx, cy)	Major Axis, a	Minor Axis, b	Ellipse Rotation Angle
2700K	Single 3-step MacAdam ellipse	(0.4578, 0.4101)	0.00810	0.00420	53.70°
2700K	Single 5-step MacAdam ellipse	(0.4578, 0.4101)	0.01350	0.00700	53.70°

Color Bin Structure, Continued

L135-4080-0XHV-00001 Color Bin Structure

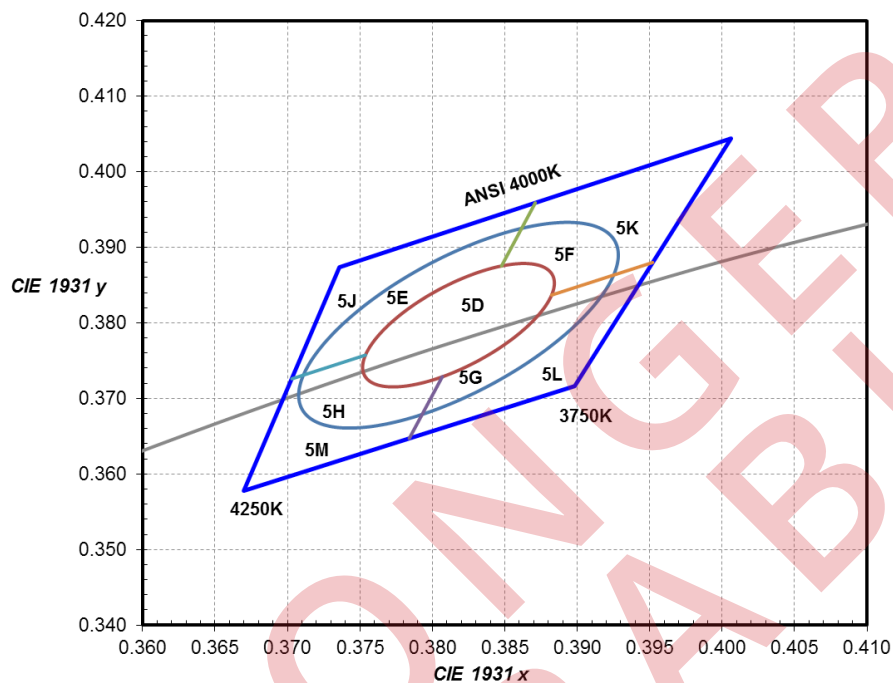

Figure 15. 4000K 1/9th color bin structure.

Table 13.

Nominal ANSI CCT	Color Space	Target Center Point (cx, cy)	Major Axis, a	Minor Axis, b	Ellipse Rotation Angle
4000K	Single 3-step MacAdam ellipse	(0.3818, 0.3797)	0.00939	0.00402	53.72°
4000K	Single 5-step MacAdam ellipse	(0.3818, 0.3797)	0.01565	0.00670	53.72°

Color Bin Structure, Continued

L135-5080-0XHV-00001 Color Bin Structure

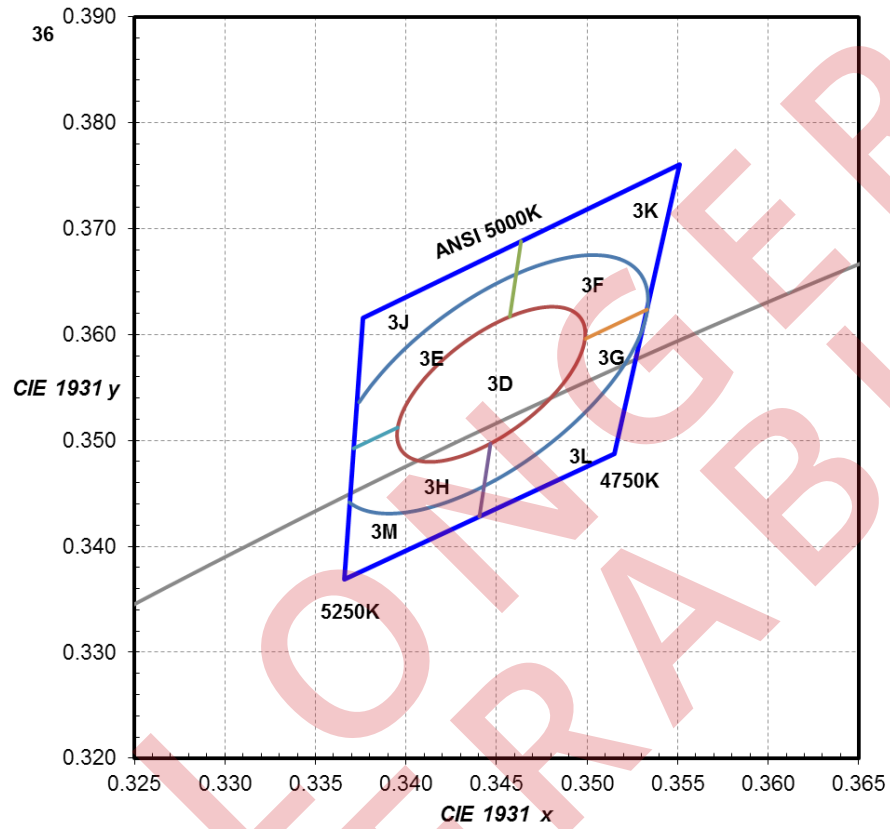

Figure 16. 5000K 1/9th color bin structure.

Table 14.

Nominal ANSI CCT	Color Space	Target Center Point (cx, cy)	Major Axis, a	Minor Axis, b	Ellipse Rotation Angle
5000K	Single 3-step MacAdam ellipse	(0.3447, 0.3553)	0.00822	0.00354	59.62°
5000K	Single 5-step MacAdam ellipse	(0.3447, 0.3553)	0.01370	0.00590	59.62°

About Lumileds

Lumileds is the global leader in light engine technology. The company develops, manufactures and distributes groundbreaking LEDs and automotive lighting products that shatter the status quo and help customers gain and maintain a competitive edge.

With a rich history of industry “firsts,” Lumileds is uniquely positioned to deliver lighting advancements well into the future by maintaining an unwavering focus on quality, innovation and reliability.

To learn more about our portfolio of light engines, visit lumileds.com.

NO LONGER AVAILABLE



©2016 Lumileds Holding B.V. All rights reserved.
LUXEON is a registered trademark of the Lumileds Holding B.V.
in the United States and other countries.

lumileds.com

Neither Lumileds Holding B.V. nor its affiliates shall be liable for any kind of loss of data or any other damages, direct, indirect or consequential, resulting from the use of the provided information and data. Although Lumileds Holding B.V. and/or its affiliates have attempted to provide the most accurate information and data, the materials and services information and data are provided “as is,” and neither Lumileds Holding B.V. nor its affiliates warrants or guarantees the contents and correctness of the provided information and data. Lumileds Holding B.V. and its affiliates reserve the right to make changes without notice. You as user agree to this disclaimer and user agreement with the download or use of the provided materials, information and data.

X-ON Electronics

Largest Supplier of Electrical and Electronic Components

Click to view similar products for [High Power LEDs - White category](#):

Click to view products by [Philips Lumileds manufacturer](#):

Other Similar products are found below :

[LTW-K140SZR40](#) [B42180-08](#) [STW8Q2PA-R5-HA](#) [LTPL-P00DWS57](#) [LTW-K140SZR30](#) [LZP-D0WW00-0000](#) [SZ5-M1-WW-C8-V1/V3-FA](#) [LTW-K140SZR57](#) [LTW-K140SZR27](#) [BXRE-50C2001-C-74](#) [MP-5050-8100-27-80](#) [MP-5050-6100-65-80](#) [MP-5050-6100-40-80](#) [MP-5050-6100-30-80](#) [KW DPLS32.SB-6H6J-E5P7-EG-Z264](#) [L1V1-507003V500000](#) [KW DMLS33.SG-Z6M7-EBVFFCBB46-8E8G-700-S](#) [ASMT-MW05-NMNS1](#) [KW DPLS33.KD-HIJG-D30D144-HN-22C2-120-S](#) [KW DDLM31.EH-5J6K-A737-W4A4-140-R18](#) [GW](#) [JTLRS1.CM-K1LW-XX57-1-100-Q-R33](#) [KW DDLM31.EH-5J6K-A636-W4A4-140-R18](#) [KW DDLM31.EH-5J6K-A131-W4A4-140-R18](#) [SML-LXL8047MWCTR/3](#) [L2C5-40HG1203E0900](#) [JB3030AWT-P-U27EA0000-N0000001](#) [JK3030AWT-P-U30EA0000-N0000001](#) [JK3030AWT-P-B40EB0000-N0000001](#) [JK3030AWT-P-H30EB0000-N0000001](#) [JK3030AWT-P-H40EB0000-N0000001](#) [JK3030AWT-P-U27EB0000-N0000001](#) [JK3030AWT-P-U30EB0000-N0000001](#) [XPGBWT-HE-0000-00JE5](#) [GW PUSTA1.PM-PAPC-XX53-1-1050-R18](#) [BXRE-30E4000-C-83](#) [BXRE-50C6501-D-84](#) [BXRE-27E1000-B-83](#) [BXRE-30G0800-D-83](#) [BXRE-50C4001-B-84](#) [BXRH-40E4000-F-83](#) [BXRH-27G4000-F-83](#) [BXRE-27E4000-B-83](#) [BXRE-27E4000-C-83](#) [BXRE-27G30H0-D-82](#) [BXRE-27G4000-B-83](#) [BXRE-40E1000-B-83](#) [BXRE-40E6500-D-83](#) [BXRH-27E1000-B-83](#) [BXRH-27E4000-F-83](#) [BXRH-27G1000-B-83](#)