

Thermal device circuit breaker - TCP 6A - 0712275

Please be informed that the data shown in this PDF Document is generated from our Online Catalog. Please find the complete data in the user's documentation. Our General Terms of Use for Downloads are valid (<http://phoenixcontact.com/download>)



Thermal miniature circuit breaker, pluggable in screw-type fuse terminal block UK 6-FSI/C and spring-cage fuse terminal block ST 4-FSI/C

Your advantages

- A version with screw or spring-cage connection is used as a basic terminal block
- The reclosable thermal circuit breaker is available in ten nominal current levels ranging from 0.1 to 10 A
- Compact design
- The integrated switching function enables immediate reclosure and therefore ensures the availability of the system

Key Commercial Data

Packing unit	20 pc
GTIN	 4 017918 848392
GTIN	4017918848392
Sales Key	07

Technical data

General

Installation instructions	When mounted in rows, the nominal device current can be limited to just 80% or must be oversized accordingly.
Mounting type	on base element
Color	black
Number of positions	1
Overvoltage category	II
Insulating material	PPS
Flammability rating according to UL 94	V0

Electrical data

Fuse	Slow-blow
Fuse type	Automatic device

Thermal device circuit breaker - TCP 6A - 0712275

Technical data

Electrical data

Rated surge voltage	2.5 kV
Rated voltage	250 V AC
	65 V DC
	250 V (AC according to UL 1077)
	72 V (DC according to UL 1077)
Rated current I_N	6 A
Insulation resistance R_{iso}	> 100 M Ω (500 V DC)
Rated short-circuit switching capacity I_{cn}	48 A (250 V AC / 65 V DC)
	60 A (30 V DC)
Short-circuit switching capacity	2000 A (250 V AC / UL 1077)
	2000 A (72 V DC / UL 1077)
Dielectric strength	3000 V AC (Actuation area)
	1500 V AC (Installation area)
Switching cycles, max.	6000 (At 1 x I_N , low-induction)
	3000 (At 1 x I_N , inductive)
	500 (At 2 x I_N , inductive)
Degree of pollution	2
Overvoltage category	II
Insulating material group	IIIb

Dimensions

Height	24.4 mm
Width	8.2 mm
Depth	44.5 mm
Height NS 35/7,5	55 mm

Ambient conditions

Degree of protection	IP40 (Actuation area)
Ambient temperature (operation)	-20 °C ... 60 °C

Standards and Regulations

Standards/specifications	EN 60934
--------------------------	----------

Environmental Product Compliance

China RoHS	Environmentally friendly use period: unlimited = EFUP-e
	No hazardous substances above threshold values

Drawings

Thermal device circuit breaker - TCP 6A - 0712275

Application drawing

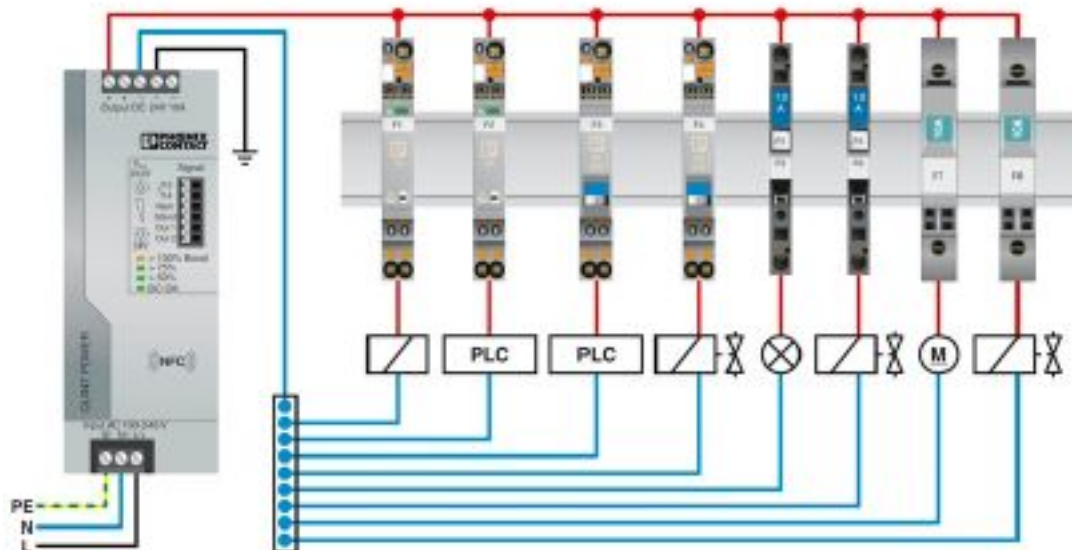

Diagram

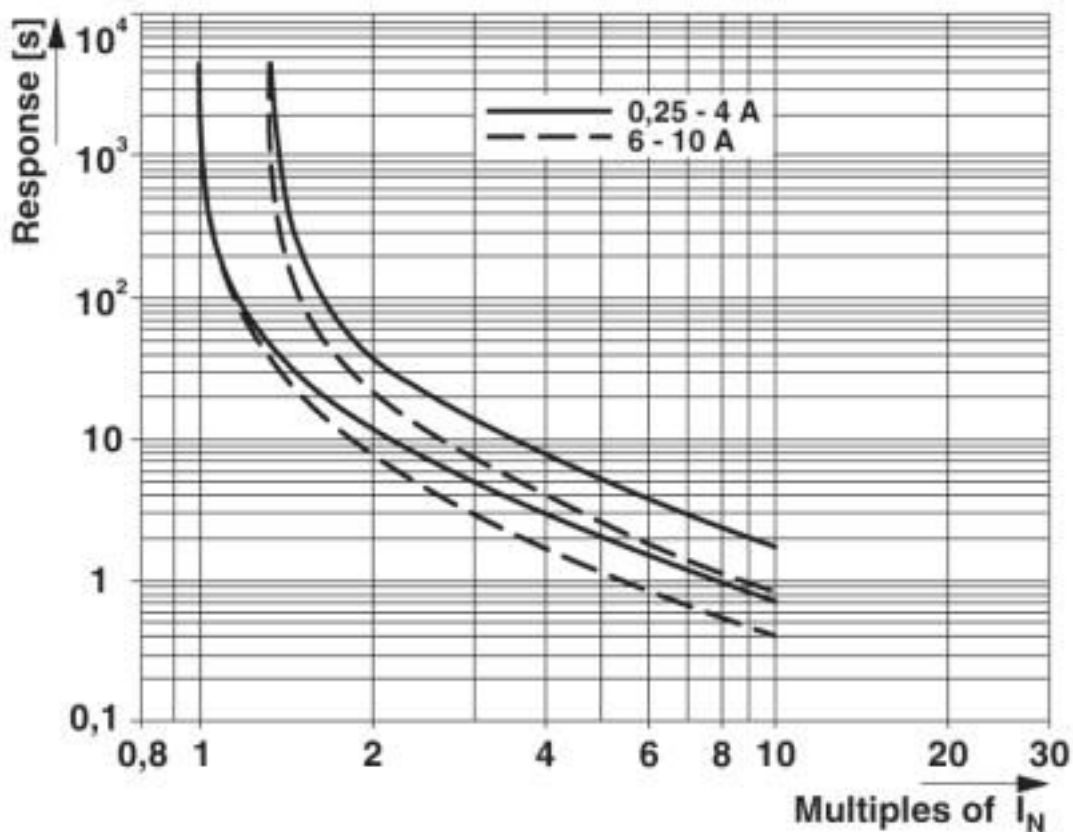

Thermal device circuit breaker - TCP 6A - 0712275

Classifications

eCl@ss

eCl@ss 10.0.1	27141116
eCl@ss 4.0	27141100
eCl@ss 4.1	27141100
eCl@ss 5.0	27141100
eCl@ss 5.1	27141100
eCl@ss 6.0	27141100
eCl@ss 7.0	27141116
eCl@ss 8.0	27141116
eCl@ss 9.0	27141116

ETIM

ETIM 2.0	EC000899
ETIM 3.0	EC000899
ETIM 4.0	EC000899
ETIM 5.0	EC000899
ETIM 6.0	EC000899
ETIM 7.0	EC000899

UNSPSC

UNSPSC 6.01	30211812
UNSPSC 7.0901	39121411
UNSPSC 11	39121411
UNSPSC 12.01	39121411
UNSPSC 13.2	39121410
UNSPSC 18.0	39121410
UNSPSC 19.0	39121410
UNSPSC 20.0	39121410
UNSPSC 21.0	39121410

Approvals

Approvals

Approvals

CSA / UL Recognized / cUL Recognized / VDE Zeichengenehmigung / EAC / CCC / EAC / cULus Recognized

Ex Approvals

Approval details

Thermal device circuit breaker - TCP 6A - 0712275

Approvals

CSA		http://www.csagroup.org/services-industries/product-listing/	074317
Nominal voltage UN		250 V	
Nominal current IN		6 A	

UL Recognized		http://database.ul.com/cgi-bin/XYV/template/LISEXT/1FRAME/index.htm	FILE E 140459
---------------	--	---	---------------

cUL Recognized		http://database.ul.com/cgi-bin/XYV/template/LISEXT/1FRAME/index.htm	FILE E 140459
----------------	--	---	---------------

VDE Zeichengenehmigung		http://www2.vde.com/de/Institut/Online-Service/VDE-gepruefteProdukte/Seiten/Online-Suche.aspx	40034332
------------------------	--	---	----------

EAC			EAC-Zulassung
-----	--	--	---------------

CCC			2019010307241945
-----	--	--	------------------

EAC			RU C- DE.A*30.B01546
-----	--	--	-------------------------

cULus Recognized			
------------------	--	--	--

Accessories

Accessories

Terminal marking

Thermal device circuit breaker - TCP 6A - 0712275

Accessories

Flat zack marker sheet - ZBFM 5/WH:UNBEDRUCKT - 0803595



Flat zack marker sheet, Sheet, white, unlabeled, can be labeled with: CMS-P1-PLOTTER, PLOTMARK, mounting type: snap into flat marker groove, for terminal block width: 5.2 mm, lettering field size: 5 x 4.5 mm, Number of individual labels: 120

Flat zack marker sheet - ZBFM 5/OG:UNBEDRUCKT - 0807180



Flat zack marker sheet, Sheet, orange, unlabeled, can be labeled with: CMS-P1-PLOTTER, PLOTMARK, mounting type: snap into flat marker groove, for terminal block width: 5.2 mm, lettering field size: 5 x 4.5 mm, Number of individual labels: 120

Additional products

Fuse modular terminal block - ST 4-FSI/C - 3036372



Fuse modular terminal block, fuse type: Flat, connection method: Spring-cage connection, cross section: 0.08 mm²-6 mm², AWG: 28 - 10, nominal current: 30 A, nom. voltage: 400 V, width: 8.2 mm, fuse type: C, mounting type: NS 35/7,5, NS 35/15, color: black

Fuse modular terminal block - ST 4-FSI/C-LED 12 - 3036495



Fuse terminal block with LED for mounting on NS 35, for miniature circuit breakers, terminal width: 8.2 mm, color: Black

Fuse modular terminal block - ST 4-FSI/C-LED 24 - 3036505



Fuse terminal block with LED for mounting on NS 35, for miniature circuit breakers, terminal width: 8.2 mm, color: Black

Thermal device circuit breaker - TCP 6A - 0712275

Accessories

Fuse modular terminal block - UK 6-FSI/C - 3118203



Flat-type fuse terminal block, cross section: 0.2 - 6 mm², AWG: 26 - 8, width: 8.2 mm, color: black

Fuse modular terminal block - UK 6-FSI/C-LED12 - 3001925



Flat-type fuse terminal block, cross section: 0.2 - 6 mm², AWG: 26 - 8, width: 8.2 mm, color: black, with light indicator, voltage light indicator: 12 V DC, current light indicator: 2 mA

Fuse modular terminal block - UK 6-FSI/C-LED24 - 3001938



Flat-type fuse terminal block, cross section: 0.2 - 6 mm², AWG: 26 - 8, width: 8.2 mm, color: black, with light indicator, voltage light indicator: 24 V DC, current light indicator: 2 mA

Fuse modular terminal block - PT 6-FSI/C - 3212166



Fuse modular terminal block, fuse type: Flat, connection method: Push-in connection, cross section: 0.5 mm²- 10 mm², AWG: 20 - 8, nominal current: 25 A, nom. voltage: 400 V, width: 8.2 mm, fuse type: Type C / max. 2.2 W, mounting type: NS 35/7,5, NS 35/15, color: black

Fuse modular terminal block - PT 6-FSI/C-LED 12 - 3212169



Fuse modular terminal block, fuse type: Flat, connection method: Push-in connection, cross section: 0.5 mm²- 10 mm², AWG: 20 - 8, nominal current: 25 A, nom. voltage: 12 V, width: 8.2 mm, fuse type: Type C / max. 2.2 W, mounting type: NS 35/7,5, NS 35/15, color: black

Thermal device circuit breaker - TCP 6A - 0712275

Accessories

Fuse modular terminal block - PT 6-FSI/C-LED 24 - 3212172



Fuse modular terminal block, fuse type: Flat, connection method: Push-in connection, cross section: 0.5 mm²-10 mm², AWG: 20 - 8, nominal current: 25 A, nom. voltage: 24 V, width: 8.2 mm, fuse type: Type C / max. 2.2 W, mounting type: NS 35/7,5, NS 35/15, color: black

Fuse modular terminal block - PT 6-FSI/C-LED 48 - 3212175



Fuse modular terminal block, fuse type: Flat, connection method: Push-in connection, cross section: 0.5 mm²-10 mm², AWG: 20 - 8, nominal current: 25 A, nom. voltage: 48 V, width: 8.2 mm, fuse type: Type C / max. 2.2 W, mounting type: NS 35/7,5, NS 35/15, color: black

Phoenix Contact 2020 © - all rights reserved
<http://www.phoenixcontact.com>

PHOENIX CONTACT GmbH & Co. KG
Flachsmarktstr. 8
32825 Blomberg
Germany
Tel. +49 5235 300
Fax +49 5235 3 41200
<http://www.phoenixcontact.com>

X-ON Electronics

Largest Supplier of Electrical and Electronic Components

Click to view similar products for [Circuit Breakers](#) category:

Click to view products by [Phoenix Contact](#) manufacturer:

Other Similar products are found below :

[LUGZX66-1-61-20.0-44](#) [M39019/01-201](#) [M39019/01-201S](#) [M39019/01-221](#) [M39019/01-323](#) [M39019/01-333](#) [M39019/01-336](#) [M39019/02-248](#) [M39019/02-311](#) [M39019/02-316](#) [M39019/04-249S](#) [M39019/05-246S](#) [M39019/06-254S](#) [M55629/1-016](#) [M55629/1-018](#) [M55629/1-021](#) [M55629/1-033](#) [M55629/1-036](#) [M55629/1-046](#) [M55629/1-048](#) [M55629/1-058](#) [M55629/1-067](#) [M55629/1-070](#) [M55629/1-079](#) [M55629/1-084](#) [M55629/1-085](#) [M55629/1-101](#) [M55629/1-109](#) [M55629/11-102](#) [M55629/1-120](#) [M55629/12-045](#) [M55629/12-046](#) [M55629/1-330](#) [M55629/1-366](#) [M55629/1-387](#) [M55629/1-401](#) [M55629/1-450](#) [M55629/2-022](#) [M55629/2-030](#) [M55629/2-072](#) [M55629/2-082](#) [M55629/2-099](#) [M55629/2-101](#) [M55629/2-102](#) [M55629/21-BM-BM](#) [M55629/21-HM-HM](#) [M55629/21-NS-NS](#) [M55629/22-NR-NR-NR](#) [M55629/22-RS-RS-RS](#) [M55629/2-347](#)