

# Panel feed-through terminal block - HDFKV 10-HV - 0717238

Please be informed that the data shown in this PDF Document is generated from our Online Catalog. Please find the complete data in the user's documentation. Our General Terms of Use for Downloads are valid (<http://phoenixcontact.com/download>)



Panel feed-through terminal block, connection method: Screw connection with tension sleeve, Screw connection with tension sleeve, number of positions: 1, load current: 57 A, cross section: 0.5 mm<sup>2</sup> - 16 mm<sup>2</sup>, connection direction of the conductor to plug-in direction: -90 °, width: 10.1 mm, color: gray

The figure shows a 7-position version

## Your advantages

- Well-known connection principle allows worldwide use
- Low temperature rise, thanks to maximum contact force
- Tool-free snap-in principle enables easy mounting on the device panel
- Automatic panel thickness compensation enables universal use

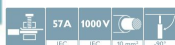

## Key Commercial Data

Packing unit	50 pc
Minimum order quantity	50 pc
GTIN	
GTIN	4017918904463

## Technical data

### Item properties

Brief article description	Panel feed-through terminal block
Range of articles	HDFKV 10-HV
Pitch	10.1 mm
Number of positions	1
Connection method	Screw connection with tension sleeve
Number of connections	2
Number of potentials	1

### Electrical parameters

Nominal current	57 A
Nom. voltage	1000 V

# Panel feed-through terminal block - HDFKV 10-HV - 0717238

## Technical data

### Electrical parameters

Rated voltage	1000 V
Rated surge voltage (III/3)	8 kV

### Connection capacity, external

Connection method	Screw connection with tension sleeve
Connection direction of the conductor to plug-in direction	-90 °
Conductor cross section solid	0.5 mm <sup>2</sup> ... 16 mm <sup>2</sup>
Conductor cross section flexible	0.5 mm <sup>2</sup> ... 10 mm <sup>2</sup>
Conductor cross section flexible, with ferrule without plastic sleeve	0.5 mm <sup>2</sup> ... 10 mm <sup>2</sup>
Conductor cross section, flexible, with ferrule, with plastic sleeve	0.5 mm <sup>2</sup> ... 10 mm <sup>2</sup>
2 conductors with same cross section, solid	0.5 mm <sup>2</sup> ... 4 mm <sup>2</sup>
2 conductors with same cross section, flexible	0.5 mm <sup>2</sup> ... 4 mm <sup>2</sup>
2 conductors with same cross section, flexible, with ferrule without plastic sleeve	0.5 mm <sup>2</sup> ... 2.5 mm <sup>2</sup>
2 conductors with the same cross section, flexible, with TWIN ferrule with plastic sleeve	0.5 mm <sup>2</sup> ... 6 mm <sup>2</sup>
Internal cylindrical gage	B6
Stripping length	11 mm
Torque	1.5 Nm ... 1.8 Nm

### Connection capacity, internal

Connection method	Screw connection with tension sleeve
Connection direction of the conductor to plug-in direction	-90 °
Conductor cross section solid	0.5 mm <sup>2</sup> ... 16 mm <sup>2</sup>
Conductor cross section flexible	0.5 mm <sup>2</sup> ... 10 mm <sup>2</sup>
Conductor cross section flexible, with ferrule without plastic sleeve	0.5 mm <sup>2</sup> ... 10 mm <sup>2</sup>
Conductor cross section, flexible, with ferrule, with plastic sleeve	0.5 mm <sup>2</sup> ... 10 mm <sup>2</sup>
2 conductors with same cross section, solid	0.5 mm <sup>2</sup> ... 4 mm <sup>2</sup>
2 conductors with same cross section, flexible	0.5 mm <sup>2</sup> ... 4 mm <sup>2</sup>
2 conductors with same cross section, flexible, with ferrule without plastic sleeve	0.5 mm <sup>2</sup> ... 2.5 mm <sup>2</sup>
2 conductors with the same cross section, flexible, with TWIN ferrule with plastic sleeve	0.5 mm <sup>2</sup> ... 6 mm <sup>2</sup>
Internal cylindrical gage	B6
Stripping length	11 mm
Torque	1.5 Nm ... 1.8 Nm

### Material data - contact

Note	WEEE/RoHS-compliant, free of whiskers according to IEC 60068-2-82/ JEDEC JESD 201
Contact material	Cu alloy
Surface characteristics	tin-plated

### Material data - housing

Housing color	gray (7042)
---------------	-------------

# Panel feed-through terminal block - HDFKV 10-HV - 0717238

## Technical data

### Material data - housing

Insulating material	PA
Insulating material group	I
CTI according to IEC 60112	600
Flammability rating according to UL 94	V0
Glow wire flammability index GWFI according to EN 60695-2-12	850
Glow wire ignition temperature GWIT according to EN 60695-2-13	775
Temperature for the ball pressure test according to EN 60695-10-2	125 °C

### Dimensions for the product

Width [ w ]	10.1 mm
Height [ h ]	34.7 mm
Pitch	10.1 mm

### Packaging information

Pieces per package	50
Denomination packing units	Pcs.

### General product information

Type of note	Notes on safety
Note	The cable entry funnel is not touch-proof. Never connect or disconnect the terminal when it is energized. Take appropriate steps to ensure touch proofness.

### Electrical tests

Rated current	57 A
Conductor cross section	10 mm²

### Air clearances and creepage distances

Clearances and creepage distances	IEC 60947-7-1:1989-10 + AMD 1:1999-06
Specification	IEC 60947-7-1:1989-10 + AMD 1:1999-06
Minimum clearance - inhomogeneous field (III/3)	8 mm
Minimum creepage distance value (III/3)	12.5 mm

### Standards and Regulations

Connection in acc. with standard	CUL
	IEC 60947-7-1
Flammability rating according to UL 94	V0
Safety note	<ul style="list-style-type: none"> <li>• WARNING: Only electrically qualified personnel may install and operate the product. They must observe the following safety notes. The qualified personnel must be familiar with the basics of electrical engineering. They must be able to recognize and prevent danger. The relevant symbol on the packaging indicates that only personnel familiar with electrical engineering are allowed to install and operate the product.</li> <li>• The installation notes/Design In documents online on the download page at phoenixcontact.com/products must be observed for this product.</li> </ul>

# Panel feed-through terminal block - HDFKV 10-HV - 0717238

## Technical data

### Standards and Regulations

	<ul style="list-style-type: none"><li>• The cable entry funnel is not safe to touch. Never connect or disconnect the terminal when it is energized. Take appropriate steps to ensure touch protection.</li></ul>
--	--

### Environmental Product Compliance

REACH SVHC	Lead 7439-92-1
China RoHS	Environmentally Friendly Use Period = 50 years
	For details about hazardous substances go to tab "Downloads", Category "Manufacturer's declaration"

## Drawings

Dimensional drawing

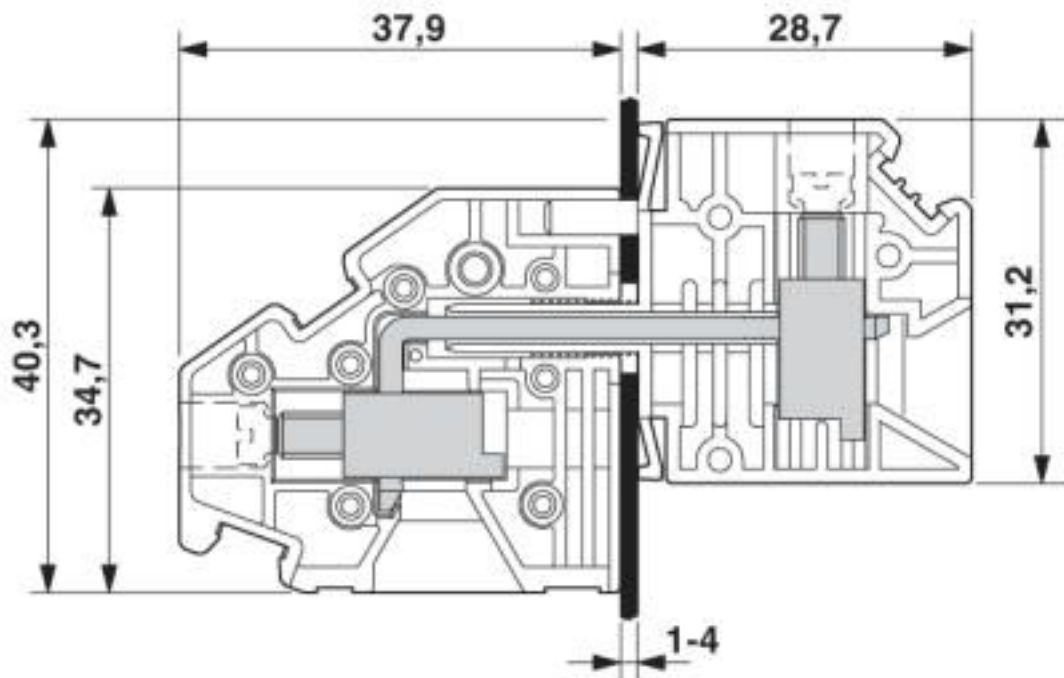

# Panel feed-through terminal block - HDFKV 10-HV - 0717238

Dimensional drawing

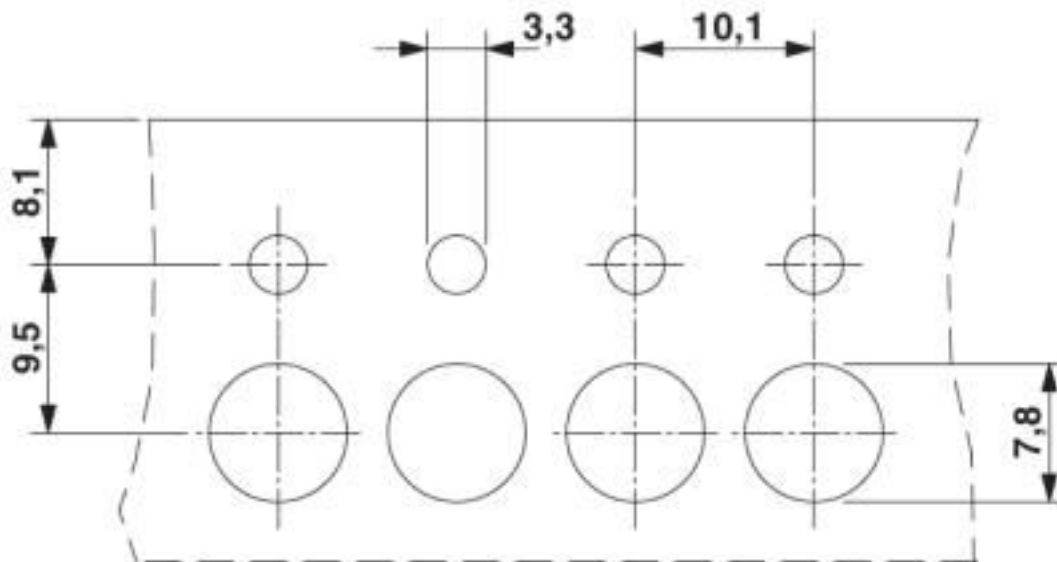

## Classifications

eCl@ss

eCl@ss 10.0.1	27141134
eCl@ss 4.0	27141100
eCl@ss 4.1	27141100
eCl@ss 5.0	27141100
eCl@ss 5.1	27141100
eCl@ss 6.0	27141100
eCl@ss 7.0	27141134
eCl@ss 8.0	27141134
eCl@ss 9.0	27141134

ETIM

ETIM 2.0	EC001283
ETIM 3.0	EC001283
ETIM 4.0	EC001283
ETIM 5.0	EC001283
ETIM 6.0	EC001283
ETIM 7.0	EC001283

UNSPSC

UNSPSC 6.01	30211811
UNSPSC 7.0901	39121410
UNSPSC 11	39121410
UNSPSC 12.01	39121410
UNSPSC 13.2	39121410

# Panel feed-through terminal block - HDFKV 10-HV - 0717238

## Classifications

### UNSPSC

UNSPSC 18.0	39121410
UNSPSC 19.0	39121410
UNSPSC 20.0	39121410
UNSPSC 21.0	39121410

## Approvals

### Approvals

#### Approvals

KEMA-KEUR / IECCE CB Scheme / EAC / cULus Recognized

#### Ex Approvals

### Approval details

KEMA-KEUR		<a href="http://www.dekra-certification.com">http://www.dekra-certification.com</a>	2169260.01
Nominal voltage UN	1000 V		
Nominal current IN	57 A		
mm <sup>2</sup> /AWG/kcmil	10		

IECEE CB Scheme		<a href="http://www.iecee.org/">http://www.iecee.org/</a>	NL-10852
Nominal voltage UN	1000 V		
Nominal current IN	57 A		
mm <sup>2</sup> /AWG/kcmil	10		

EAC		B.01687
-----	---	---------

## Panel feed-through terminal block - HDFKV 10-HV - 0717238

### Approvals

cULus Recognized		<a href="http://database.ul.com/cgi-bin/XYV/template/LISEXT/1FRAME/index.htm">http://database.ul.com/cgi-bin/XYV/template/LISEXT/1FRAME/index.htm</a>	E60425-19870911
	B	C	
Nominal voltage UN	600 V	600 V	
Nominal current IN	65 A	65 A	
mm <sup>2</sup> /AWG/kcmil	24-6	24-6	

Phoenix Contact 2020 © - all rights reserved  
<http://www.phoenixcontact.com>

PHOENIX CONTACT GmbH & Co. KG  
Flachsmarktstr. 8  
32825 Blomberg  
Germany  
Tel. +49 5235 300  
Fax +49 5235 3 41200  
<http://www.phoenixcontact.com>

## X-ON Electronics

Largest Supplier of Electrical and Electronic Components

*Click to view similar products for [Fixed Terminal Blocks](#) category:*

*Click to view products by [Phoenix Contact](#) manufacturer:*

Other Similar products are found below :

[MBE-1512](#) [MBE-154](#) [MBE-156](#) [MBES-153](#) [MBES-156](#) [MH-2512](#) [MHE-132](#) [MHE-163](#) [MI-254 \(35\)](#) [MI-272](#) [880507](#) [MPT-275](#)  
[15602-04-08-21](#) [BA311TU](#) [BA411SU](#) [MV-152](#) [MV-252-D](#) [MV-253/NCNOC](#) [MV-254-D](#) [MV-255](#) [MV-462](#) [MV-493](#) [MVE-252](#) [MVE-253](#)  
[MVE-273](#) [MVEB-153](#) [1700096](#) [1705142](#) [1712417](#) [1713020](#) [1713088](#) [1745195](#) [1760594](#) [1776118-2](#) [1790852](#) [1-796689-8](#) [1-796692-6](#)  
[1800001](#) [1800114](#) [1995279](#) [20020314-C121B01LF](#) [20020316-G041B01LF](#) [CB2-12](#) [KP03215000J0G](#) [KP04215000J0G](#) [S451](#) [282802-2](#)  
[29.007](#) [29.116](#) [30.103](#)