

Cable sleeve - CES-SRG-BK-13 - 0801616

Please be informed that the data shown in this PDF Document is generated from our Online Catalog. Please find the complete data in the user's documentation. Our General Terms of Use for Downloads are valid (<http://phoenixcontact.com/download>)



Cable sleeve, no. of conductors: 1, length: 29.5 mm, width: 19.5 mm, height: 17 mm, external cable diameter: 1x 12 mm ... 13 mm , color: black

Product Description

Slotted cable sleeve



Key Commercial Data

Packing unit	10 pc
GTIN	 4 046356 674720
GTIN	4046356674720

Technical data

Dimensions

External cable diameter	1x 12 mm ... 13 mm
Length	29.5 mm
Width	19.5 mm
Height	17 mm

Ambient conditions

Degree of protection	IP54
Ambient temperature (operation)	-40 °C ... 125 °C (static)

General

No. of conductors	1
Material	NBR
	NBR
Color	black

Environmental Product Compliance

China RoHS	Environmentally friendly use period: unlimited = EFUP-e
------------	---

Cable sleeve - CES-SRG-BK-13 - 0801616

Technical data

Environmental Product Compliance

	No hazardous substances above threshold values
--	--

Drawings

Dimensional drawing

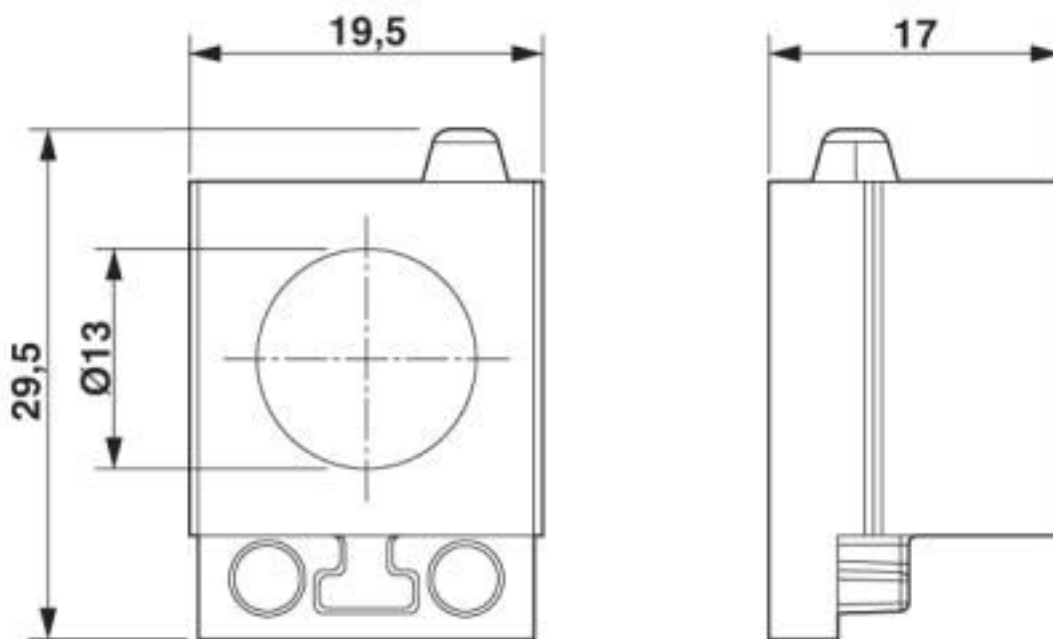

Dimensional drawing

Classifications

eCl@ss

eCl@ss 10.0.1	27144425
eCl@ss 4.0	27081000
eCl@ss 4.1	27081000
eCl@ss 5.0	27081000
eCl@ss 5.1	27081000
eCl@ss 6.0	27081000
eCl@ss 7.0	27069220
eCl@ss 8.0	27069220
eCl@ss 9.0	27144425

ETIM

ETIM 3.0	EC000879
ETIM 4.0	EC000451
ETIM 5.0	EC000451

Cable sleeve - CES-SRG-BK-13 - 0801616

Classifications

ETIM

ETIM 6.0	EC000451
ETIM 7.0	EC000451

UNSPSC

UNSPSC 6.01	30212109
UNSPSC 7.0901	39121708
UNSPSC 11	39121708
UNSPSC 12.01	39121708
UNSPSC 13.2	39121448
UNSPSC 18.0	39121448
UNSPSC 19.0	39121448
UNSPSC 20.0	39121448
UNSPSC 21.0	39121448

Approvals

Approvals

Approvals

DNV GL

Ex Approvals

Approval details

DNV GL		https://approvalfinder.dnvgl.com/	TAE00003VJ
--------	---	---	------------

Phoenix Contact 2020 © - all rights reserved
<http://www.phoenixcontact.com>

PHOENIX CONTACT GmbH & Co. KG
Flachsmarktstr. 8
32825 Blomberg
Germany
Tel. +49 5235 300
Fax +49 5235 3 41200
<http://www.phoenixcontact.com>

X-ON Electronics

Largest Supplier of Electrical and Electronic Components

Click to view similar products for [Conduit Fittings & Accessories](#) category:

Click to view products by [Phoenix Contact](#) manufacturer:

Other Similar products are found below :

[M3231GAB](#) [M3231GAC](#) [M3231GAE](#) [M3231GL](#) [M3231GT](#) [VC-937-16/RED](#) [VC-562-16/RED](#) [VC-1125-16/RED](#) [DM0240-1/2A](#) [3408B](#)
[G6002](#) [M4340GAE](#) [C2016-P](#) [C2012-P](#) [3407B](#) [1660-P](#) [561-87BG11BLK](#) [561-75BG11B](#) [1.533.1201.50](#) [1.533.1601.51](#) [BVNV-P428](#) [BVBV-](#)
[P366](#) [2276](#) [2663-P](#) [3405B](#) [C2070-P](#) [3582V](#) [4975](#) [2644-P](#) [2955](#) [M50](#) [2404-P](#) [2291](#) [2133-P](#) [3048F](#) [VC12516](#) [RC156-0500](#) [DM0523-1/2A](#)
[1035A](#) [DMS0250-1A](#) [DMS0313-1A](#) [1040A](#) [1050A](#) [R1/8A](#) [DMPC0490-1/2A](#) [DMPC0521-1/2A](#) [DMPC0552-1/2A](#) [1070A](#) [R1/2A](#) [E1-7/8B](#)
[061A](#)