

Cable sleeve - CES-STPG-GY-8 - 0801679

Please be informed that the data shown in this PDF Document is generated from our Online Catalog. Please find the complete data in the user's documentation. Our General Terms of Use for Downloads are valid (<http://phoenixcontact.com/download>)



Cable sleeve, no. of conductors: 1, length: 29.5 mm, width: 19.5 mm, height: 17 mm, external cable diameter: 1x 7 mm ... 8 mm , color: gray

Product Description

Slotted cable sleeve



Key Commercial Data

Packing unit	10 pc
Minimum order quantity	10 pc
GTIN	 4 046356 674843
GTIN	4046356674843

Technical data

Dimensions

External cable diameter	1x 7 mm ... 8 mm
Length	29.5 mm
Width	19.5 mm
Height	17 mm

Ambient conditions

Degree of protection	IP54
Ambient temperature (operation)	-40 °C ... 80 °C (static)

General

No. of conductors	1
Material	SEBS
	SEBS (halogen-free)
Flammability rating according to UL 94	V0
Color	gray

Cable sleeve - CES-STPG-GY-8 - 0801679

Technical data

Standards and Regulations

Connection in acc. with standard	CUL
Flammability rating according to UL 94	V0

Environmental Product Compliance

China RoHS	Environmentally friendly use period: unlimited = EFUP-e
	No hazardous substances above threshold values

Drawings

Dimensional drawing

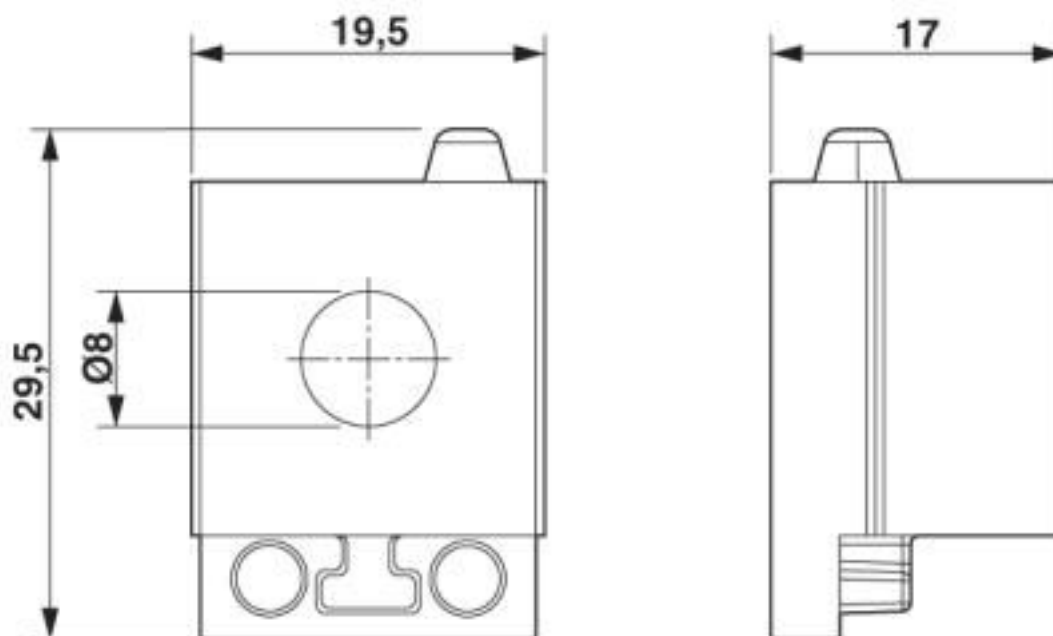

Dimensional drawing

Classifications

eCl@ss

eCl@ss 10.0.1	27144425
eCl@ss 4.0	27081000
eCl@ss 4.1	27081000
eCl@ss 5.0	27081000
eCl@ss 5.1	27081000
eCl@ss 6.0	27081000
eCl@ss 7.0	27069220
eCl@ss 8.0	27069220
eCl@ss 9.0	27144425

Cable sleeve - CES-STPG-GY-8 - 0801679

Classifications

ETIM

ETIM 3.0	EC000879
ETIM 4.0	EC000451
ETIM 5.0	EC000451
ETIM 6.0	EC000451
ETIM 7.0	EC000451

UNSPSC

UNSPSC 6.01	30212109
UNSPSC 7.0901	39121708
UNSPSC 11	39121708
UNSPSC 12.01	39121708
UNSPSC 13.2	39121448
UNSPSC 18.0	39121448
UNSPSC 19.0	39121448
UNSPSC 20.0	39121448
UNSPSC 21.0	39121448

Approvals

Approvals

Approvals

UL Recognized / cUL Recognized / DNV GL / cULus Recognized

Ex Approvals

Approval details

UL Recognized		http://database.ul.com/cgi-bin/XYV/template/LISEXT/1FRAME/index.htm	NITW2.E255026
---------------	---	---	---------------

cUL Recognized		http://database.ul.com/cgi-bin/XYV/template/LISEXT/1FRAME/index.htm	NITW8.E255026
----------------	---	---	---------------

DNV GL		https://approvalfinder.dnvgl.com/	TAE00003VJ
--------	---	---	------------

Cable sleeve - CES-STPG-GY-8 - 0801679

Approvals

cULus Recognized



Phoenix Contact 2020 © - all rights reserved
<http://www.phoenixcontact.com>

PHOENIX CONTACT GmbH & Co. KG
Flachsmarktstr. 8
32825 Blomberg
Germany
Tel. +49 5235 300
Fax +49 5235 3 41200
<http://www.phoenixcontact.com>

X-ON Electronics

Largest Supplier of Electrical and Electronic Components

Click to view similar products for [Conduit Fittings & Accessories](#) category:

Click to view products by [Phoenix Contact](#) manufacturer:

Other Similar products are found below :

[M3231GAB](#) [M3231GAC](#) [M3231GAE](#) [M3231GL](#) [M3231GT](#) [VC-937-16/RED](#) [VC-562-16/RED](#) [VC-1125-16/RED](#) [DM0240-1/2A](#) [3408B](#)
[G6002](#) [M4340GAE](#) [C2016-P](#) [C2012-P](#) [3407B](#) [1660-P](#) [561-87BG11BLK](#) [561-75BG11B](#) [1.533.1201.50](#) [1.533.1601.51](#) [BVNV-P428](#) [BVBV-](#)
[P366](#) [2276](#) [2663-P](#) [3405B](#) [C2070-P](#) [3582V](#) [4975](#) [2644-P](#) [2955](#) [M50](#) [2404-P](#) [2291](#) [2133-P](#) [3048F](#) [VC12516](#) [RC156-0500](#) [DM0523-1/2A](#)
[1035A](#) [DMS0250-1A](#) [DMS0313-1A](#) [1040A](#) [1050A](#) [R1/8A](#) [DMPC0490-1/2A](#) [DMPC0521-1/2A](#) [DMPC0552-1/2A](#) [1070A](#) [R1/2A](#) [E1-7/8B](#)
[061A](#)