

Electronic device circuit breaker - EC-E4 3A - 0903034

Please be informed that the data shown in this PDF Document is generated from our Online Catalog. Please find the complete data in the user's documentation. Our General Terms of Use for Downloads are valid (<http://phoenixcontact.com/download>)



Electronic circuit breaker, signal contact: 1 N/C contact, nominal current: 3 A

Your advantages

- ✔ Selective protection of all 24 V DC load circuits at switched-mode power supply units
- ✔ A combination of active electronic current limitation in the event of short circuit and overload shutdown ensures that the circuit breaker can respond to overloads faster than the switched-mode power supply unit
- ✔ The residual current is always limited to 1.3 - 1.8 times the nominal current

Key Commercial Data

Packing unit	6 pc
GTIN	
GTIN	4046356328098

Technical data

General

Installation instructions	When mounted in rows without convection cooling, the nominal device current should only be led to a maximum of 80% due to the thermal effect during continuous operation (100% operating factor). Special precautionary measures must be taken in systems or machines, to prevent components from restarting (e.g., use of a safety PLC). Parallel connection of multiple circuit breakers is not permitted.
Mounting type	DIN rail: 35 mm
Color	black
Number of positions	1
Flammability rating according to UL 94	V0

Electrical data

Fuse	electronic
Fuse type	Automatic device
Rated surge voltage	0.5 kV

Electronic device circuit breaker - EC-E4 3A - 0903034

Technical data

Electrical data

Operating voltage	24 V DC
	18 V DC ... 32 V DC
Nominal current I_N	3 A
Required backup fuse	not required, integrated failsafe element
Dielectric strength	max. 32 V DC (Load circuit)
Degree of pollution	2
Switching capacity I_{CN}	Active current limitation
Closed-circuit current range I_0	typ. 25 mA \pm 5 mA (When switched on)

Dimensions

Height	83 mm
Width	12.5 mm
Depth	80 mm
Height NS 35/7,5	83 mm
Height NS 35/15	90.5 mm

Ambient conditions

Degree of protection	IP20 (Housing)
Ambient temperature (operation)	0 °C ... 50 °C (non-condensing)

Connection data

Conductor cross section solid min.	0.5 mm ²
Conductor cross section solid max.	16 mm ²
Conductor cross section flexible min.	0.5 mm ²
Conductor cross section flexible max.	16 mm ²
Conductor cross section AWG min.	20
Conductor cross section AWG max.	6
Conductor cross section flexible, with ferrule without plastic sleeve min.	0.5 mm ²
Conductor cross section flexible, with ferrule without plastic sleeve max.	10 mm ²
Conductor cross section flexible, with ferrule with plastic sleeve min.	0.5 mm ²
Conductor cross section flexible, with ferrule with plastic sleeve max.	10 mm ²
2 conductors with same cross section, solid min.	0.5 mm ²
2 conductors with same cross section, solid max.	4 mm ²
2 conductors with same cross section, stranded min.	0.5 mm ²
2 conductors with same cross section, stranded max.	4 mm ²
Two conductors with the same cross section stranded, with ferrule and without plastic sleeve, minimum	0.5 mm ²
Two conductors with the same cross section stranded, with ferrule and without plastic sleeve, maximum	2.5 mm ²
Two conductors with the same cross section, flexible, with TWIN ferrules, with plastic sleeve, minimum	0.5 mm ²
Two conductors with the same cross section, flexible, with TWIN ferrules, with plastic sleeve, maximum	6 mm ²
Connection method	Screw connection

Electronic device circuit breaker - EC-E4 3A - 0903034

Technical data

Connection data

Stripping length	10 mm
Screw thread	M4
Tightening torque max	1.2 Nm

Standards and Regulations

Standards/specifications	UL 508
	CSA 22.2 No. 14
	UL 2367
	CSA 22.2 No. 142
	CSA 22.2 No. 213
	UL 1604

Environmental Product Compliance

REACH SVHC	Lead 7439-92-1
China RoHS	Environmentally Friendly Use Period = 50 years
	For details about hazardous substances go to tab "Downloads", Category "Manufacturer's declaration"

Drawings

Electronic device circuit breaker - EC-E4 3A - 0903034

Circuit diagram

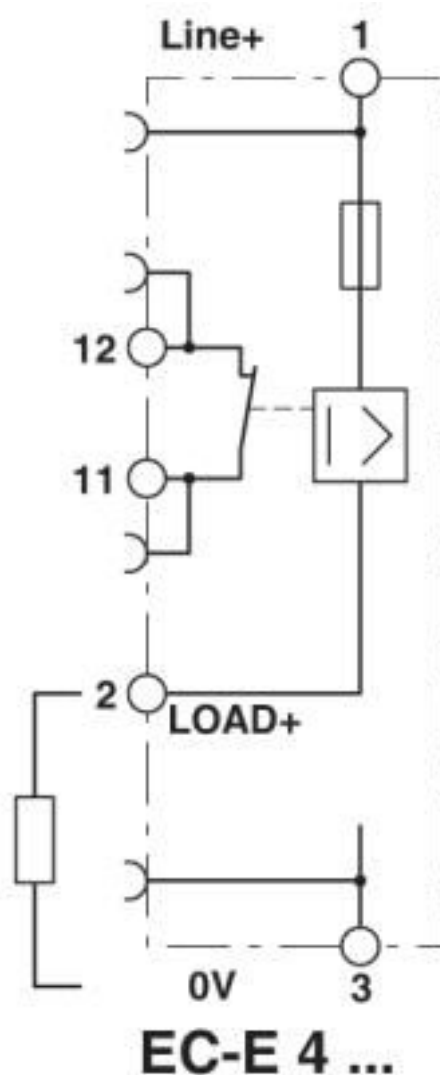

Classifications

eCl@ss

eCl@ss 10.0.1	27140401
eCl@ss 4.0	27141100
eCl@ss 4.1	27141100
eCl@ss 5.0	27141100
eCl@ss 5.1	27141100
eCl@ss 6.0	27141100
eCl@ss 7.0	27141116
eCl@ss 8.0	27141116
eCl@ss 9.0	27141116

Electronic device circuit breaker - EC-E4 3A - 0903034

Classifications

ETIM

ETIM 2.0	EC000899
ETIM 3.0	EC000899
ETIM 4.0	EC000899
ETIM 5.0	EC000899
ETIM 6.0	EC000899
ETIM 7.0	EC000899

UNSPSC

UNSPSC 6.01	30211812
UNSPSC 7.0901	39121411
UNSPSC 11	39121411
UNSPSC 12.01	39121411
UNSPSC 13.2	39121410
UNSPSC 18.0	39121410
UNSPSC 19.0	39121410
UNSPSC 20.0	39121410
UNSPSC 21.0	39121410

Approvals

Approvals

Approvals

DNV GL / UL Listed / UL Recognized / cUL Listed / cULus Listed

Ex Approvals

UL Recognized / CSA

Approval details

DNV GL		https://approvalfinder.dnvgl.com/	TAE00002HC
--------	--	---	------------

UL Listed		http://database.ul.com/cgi-bin/XYV/template/LISEXT/1FRAME/index.htm	FILE E 140324
-----------	--	---	---------------

Electronic device circuit breaker - EC-E4 3A - 0903034

Approvals

UL Recognized		http://database.ul.com/cgi-bin/XYV/template/LISEXT/1FRAME/index.htm	FILE E 317172
---------------	--	---	---------------

cUL Listed		http://database.ul.com/cgi-bin/XYV/template/LISEXT/1FRAME/index.htm	FILE E 140324
------------	--	---	---------------

cULus Listed			
--------------	--	--	--

Accessories

Accessories

Bridge

Continuous plug-in bridge - FBST 500-PLC BU - 2966692



Continuous plug-in bridge, length: 500 mm, color: blue

Continuous plug-in bridge - FBST 500-PLC RD - 2966786



Continuous plug-in bridge, length: 500 mm, color: red

Continuous plug-in bridge - FBST 500 TMC-N GY - 0901028



Continuous plug-in bridge, mounting type: Plug-in mounting, Color: gray

DIN rail

Electronic device circuit breaker - EC-E4 3A - 0903034

Accessories

DIN rail perforated - NS 35/ 7,5 PERF 2000MM - 0801733



DIN rail perforated, Standard profile, width: 35 mm, height: 7.5 mm, acc. to EN 60715, material: Steel, galvanized, passivated with a thick layer, length: 2000 mm, color: silver

DIN rail, unperforated - NS 35/ 7,5 CU UNPERF 2000MM - 0801762



DIN rail, unperforated, Standard profile, width: 35 mm, height: 7.5 mm, acc. to EN 60715, material: Copper, uncoated, length: 2000 mm, color: copper-colored

DIN rail, unperforated - NS 35/15 UNPERF 2000MM - 1201714



DIN rail, unperforated, Standard profile, width: 35 mm, height: 15 mm, similar to EN 60715, material: Steel, galvanized, passivated with a thick layer, length: 2000 mm, color: silver

DIN rail, unperforated - NS 35/15 CU UNPERF 2000MM - 1201895



DIN rail, unperforated, Standard profile, width: 35 mm, height: 15 mm, similar to EN 60715, material: Copper, uncoated, length: 2000 mm, color: copper-colored

DIN rail, unperforated - NS 35/15-2,3 UNPERF 2000MM - 1201798



DIN rail, unperforated, Standard profile 2.3 mm, width: 35 mm, height: 15 mm, acc. to EN 60715, material: Steel, galvanized, passivated with a thick layer, length: 2000 mm, color: silver

Electronic device circuit breaker - EC-E4 3A - 0903034

Accessories

DIN rail, unperforated - NS 35/15 AL UNPERF 2000MM - 1201756



DIN rail, unperforated, Standard profile, width: 35 mm, height: 15 mm, similar to EN 60715, material: Aluminum, uncoated, length: 2000 mm, color: silver

DIN rail perforated - NS 35/15 PERF 2000MM - 1201730



DIN rail perforated, Standard profile, width: 35 mm, height: 15 mm, similar to EN 60715, material: Steel, galvanized, passivated with a thick layer, length: 2000 mm, color: silver

End block

End clamp - CLIPFIX 35-5 - 3022276



Quick mounting end clamp for NS 35/7,5 DIN rail or NS 35/15 DIN rail, with marking option, with parking option for FBS...5, FBS...6, KSS 5, KSS 6, width: 5.15 mm, color: gray

End clamp - E/UK 1 - 1201413



End clamps, for supporting the ends of double-level and three-level terminal blocks, width: 10 mm, color: gray

Screwdriver tools

Screwdriver - SZS 0,6X3,5 - 1205053



Actuation tool, for ST terminal blocks, insulated, also suitable for use as a bladed screwdriver, size: 0.6 x 3.5 x 100 mm, 2-component grip, with non-slip grip

Terminal marking

Electronic device circuit breaker - EC-E4 3A - 0903034

Accessories

Marker for terminal blocks - UC-TMF 12 - 0819233



Marker for terminal blocks, Sheet, white, unlabeled, can be labeled with: BLUEMARK ID COLOR, BLUEMARK ID, BLUEMARK CLED, PLOTMARK, CMS-P1-PLOTTER, mounting type: snap into flat marker groove, for terminal block width: 12 mm, lettering field size: 11.45 x 5.1 mm, Number of individual labels: 40

Zack Marker strip, flat - ZBF 12:UNBEDRUCKT - 0809735



Zack Marker strip, flat, Strip, white, unlabeled, can be labeled with: PLOTMARK, CMS-P1-PLOTTER, mounting type: snap into flat marker groove, for terminal block width: 12 mm, lettering field size: 5.15 x 12.15 mm, Number of individual labels: 5

Marker for terminal blocks - UCT-TMF 12 - 0829214



Marker for terminal blocks, Sheet, white, unlabeled, can be labeled with: TOPMARK NEO, TOPMARK LASER, BLUEMARK ID COLOR, BLUEMARK ID, BLUEMARK CLED, THERMOMARK PRIME, THERMOMARK CARD 2.0, THERMOMARK CARD, mounting type: snap into flat marker groove, for terminal block width: 12 mm, lettering field size: 11.2 x 4.7 mm, Number of individual labels: 30

Phoenix Contact 2020 © - all rights reserved
<http://www.phoenixcontact.com>

PHOENIX CONTACT GmbH & Co. KG
Flachsmarktstr. 8
32825 Blomberg
Germany
Tel. +49 5235 300
Fax +49 5235 3 41200
<http://www.phoenixcontact.com>

X-ON Electronics

Largest Supplier of Electrical and Electronic Components

Click to view similar products for [Circuit Breakers](#) category:

Click to view products by [Phoenix Contact](#) manufacturer:

Other Similar products are found below :

[LUGZX66-1-61-20.0-44](#) [M39019/01-201](#) [M39019/01-201S](#) [M39019/01-221](#) [M39019/01-323](#) [M39019/01-333](#) [M39019/01-336](#) [M39019/02-248](#) [M39019/02-311](#) [M39019/02-316](#) [M39019/04-249S](#) [M39019/05-246S](#) [M39019/06-254S](#) [M55629/1-016](#) [M55629/1-018](#) [M55629/1-021](#) [M55629/1-033](#) [M55629/1-036](#) [M55629/1-046](#) [M55629/1-048](#) [M55629/1-058](#) [M55629/1-067](#) [M55629/1-070](#) [M55629/1-079](#) [M55629/1-084](#) [M55629/1-085](#) [M55629/1-101](#) [M55629/1-109](#) [M55629/11-102](#) [M55629/1-120](#) [M55629/12-045](#) [M55629/12-046](#) [M55629/1-330](#) [M55629/1-366](#) [M55629/1-387](#) [M55629/1-401](#) [M55629/1-450](#) [M55629/2-022](#) [M55629/2-030](#) [M55629/2-072](#) [M55629/2-082](#) [M55629/2-099](#) [M55629/2-101](#) [M55629/2-102](#) [M55629/21-BM-BM](#) [M55629/21-HM-HM](#) [M55629/21-NS-NS](#) [M55629/22-NR-NR-NR](#) [M55629/22-RS-RS-RS](#) [M55629/2-347](#)