

Housing - HC-STA-B06-SHWSC-2SSM40-ELC-AL - 1082577

Please be informed that the data shown in this PDF Document is generated from our Online Catalog. Please find the complete data in the user's documentation. Our General Terms of Use for Downloads are valid (<http://phoenixcontact.com/download>)



Box mounting bases B6, with single locking latch, material: Die-cast aluminum, salt water resistant, protective cover material: PA, cable outlets: 2, lateral, height: 74.8 mm, cable gland: none, support sleeve: no, 2x M40, protective cover: yes, Standard

Your advantages

- ✔ good shielding in the event of electromagnetic interference



Key Commercial Data

Packing unit	1 pc
GTIN	
GTIN	4055626816166

Technical data

Dimensions

Height	74.8 mm
Width	52 mm
Length	84 mm

Ambient conditions

Degree of protection (IP)	IP66 (with closed protective cover) IP67 (when plugged in)
Degree of protection (NEMA)	4 (UL 50e) 4X (UL 50e) 12 (UL 50e)
Ambient temperature (operation)	-40 °C ... 125 °C

General

Note	For contact inserts HC-B6, BB10, DD24, M Tall housings for extra large wiring space
Size	B6
Housing type	Box mounting bases

Housing - HC-STA-B06-SHWSC-2SSM40-ELC-AL - 1082577

Technical data

General

Color	gray aluminum
Locking type	with single locking latch
No. of cable outlets	2
Cable outlet	lateral
Screw connection	none
Type of the screw connection	2x M40
Protective cover	yes
Housing material	Die-cast aluminum, salt water resistant
Housing surface material	uncoated
Seal material	NBR, conductive
Material lock	PA
Material, protective cover	PA
Flammability rating according to UL 94	V0 (Interlock)
	V0 (Protective cover)
Assembly instructions	One opening is sealed with a plastic filler plug and can be opened using a screwdriver.

Drawings

Dimensional drawing

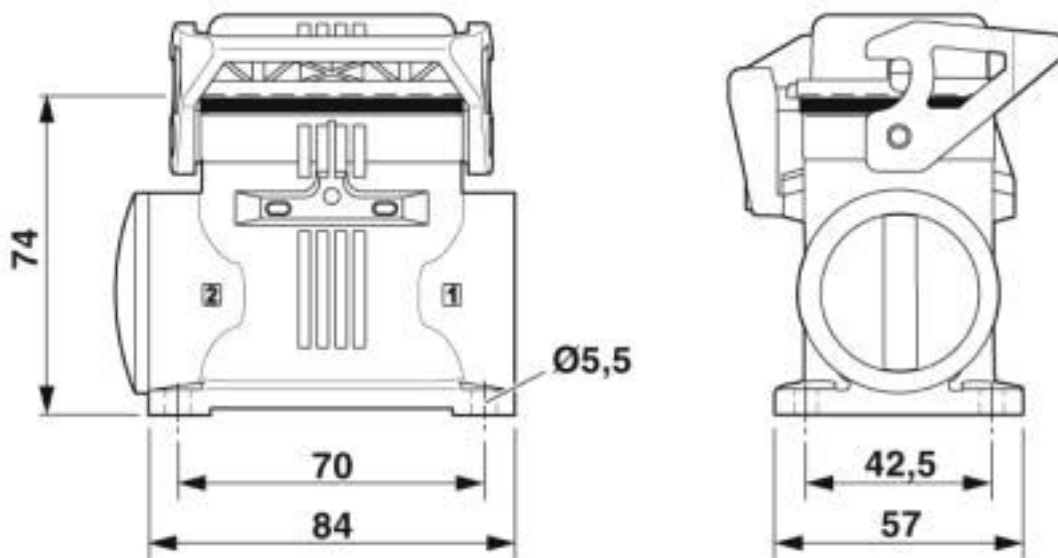

Dimensional drawing

Classifications

eCl@ss

eCl@ss 10.0.1	27440202
---------------	----------

Housing - HC-STA-B06-SHWSC-2SSM40-ELC-AL - 1082577

Classifications

eCl@ss

eCl@ss 5.1	27261200
eCl@ss 6.0	27261200
eCl@ss 7.0	27440202
eCl@ss 8.0	27440202
eCl@ss 9.0	27440202

ETIM

ETIM 5.0	EC000437
ETIM 6.0	EC000437
ETIM 7.0	EC000437

UNSPSC

UNSPSC 13.2	31261501
UNSPSC 18.0	31261501
UNSPSC 19.0	31261501
UNSPSC 20.0	31261501
UNSPSC 21.0	31261501

Accessories

Accessories

Full screw connection

Cable gland - G-INS-M40-M68N-NNES-S - 1411167



Cable gland, cable gland material: Nickel-plated brass, external cable diameter 19 mm ... 28 mm, shielding: no, connecting thread: M40 x 1.5, color: silver, with O-ring

Cable gland - G-INSEC-M40-M68N-NCRS-S - 1411192



Cable gland, cable gland material: Nickel-plated brass, external cable diameter 19 mm ... 27 mm, shielding: yes, connecting thread: M40 x 1.5, color: silver, with O-ring

Housing latches

Housing - HC-STA-B06-SHWSC-2SSM40-ELC-AL - 1082577

Accessories

Replacement part - HC-STA-B06-SL-PLBK - 1412591



Single locking latch for B6 housing, HC-EVO....AL and HC-STA....AL

Seal

Profile gasket - HC-B06-SP-CBK - 1411477



Profile gasket for HEAVYCON EVO supporting base element type B6, conductive

Phoenix Contact 2020 © - all rights reserved
<http://www.phoenixcontact.com>

PHOENIX CONTACT GmbH & Co. KG
Flachsmarktstr. 8
32825 Blomberg
Germany
Tel. +49 5235 300
Fax +49 5235 3 41200
<http://www.phoenixcontact.com>

X-ON Electronics

Largest Supplier of Electrical and Electronic Components

Click to view similar products for [Heavy Duty Power Connectors](#) category:

Click to view products by [Phoenix Contact](#) manufacturer:

Other Similar products are found below :

[647757-1](#) [6643411-1](#) [6646058-2](#) [6646137-1](#) [6646138-1](#) [6646479-1](#) [6646608-1](#) [6646786-1](#) [6646940-1](#) [6651091-1](#) [6651525-1](#) [6651529-1](#)
[6651788-1](#) [696475-1](#) [702-32-01109](#) [703-25-02205](#) [73000005059](#) [73000005642](#) [73080255059](#) [73080965046](#) [765-15-0080A](#) [765-16-0080B](#)
[765-18-0080D](#) [829992-1](#) [902-77-02113](#) [PS00/A0620/6300](#) [PS25/A0420/63](#) [129-1J](#) [1409400](#) [AN0024023](#) [E6374G1](#) [e6389g2](#) [157-43GW8](#)
[MS3117-14AC](#) [1643543-1](#) [1650540-1](#) [1651811-2](#) [1766260-1](#) [1766282-1](#) [1766966-1](#) [1791340000](#) [NLDFT-3-BL-L-S120-M40A](#) [NLDFT-N-](#)
[W-L-C240-M40B](#) [NLS-2-R-C240-M40B](#) [NLS-N-W-C240-M40B](#) [NPS-3-BL-T6](#) [1986615-1](#) [2-1589900-8](#) [2199314-1](#) [KA8102](#)