

# Housing - HC-STA-B24-SHWS-2SSM40-ELC-AL - 1082593

Please be informed that the data shown in this PDF Document is generated from our Online Catalog. Please find the complete data in the user's documentation. Our General Terms of Use for Downloads are valid (<http://phoenixcontact.com/download>)



Box mounting bases B24, with single locking latch, material: Die-cast aluminum, salt water resistant, cable outlets: 2, lateral, height: 84.7 mm, cable gland: none, support sleeve: no, 2x M40, Standard

## Your advantages

- good shielding in the event of electromagnetic interference



## Key Commercial Data

Packing unit	1 pc
GTIN	
GTIN	4055626816302

## Technical data

### Dimensions

Height	84.7 mm
Width	57 mm
Length	144 mm

### Ambient conditions

Degree of protection (IP)	IP66
	IP67
Degree of protection (NEMA)	4 (UL 50e)
	4X (UL 50e)
	12 (UL 50e)
Ambient temperature (operation)	-40 °C ... 125 °C

### General

Note	for contact inserts HC-B24, BB46, D64, DD108, HV10/16, M
Size	B24
Housing type	Box mounting bases

# Housing - HC-STA-B24-SHWS-2SSM40-ELC-AL - 1082593

## Technical data

### General

Color	gray aluminum
Locking type	with single locking latch
No. of cable outlets	2
Cable outlet	lateral
Screw connection	none
Type of the screw connection	2x M40
Housing material	Die-cast aluminum, salt water resistant
Housing surface material	uncoated
Seal material	NBR, conductive
Material lock	PA
Flammability rating according to UL 94	V0 (Interlock)
Assembly instructions	One opening is sealed with a plastic filler plug and can be opened using a screwdriver.

## Drawings

Dimensional drawing

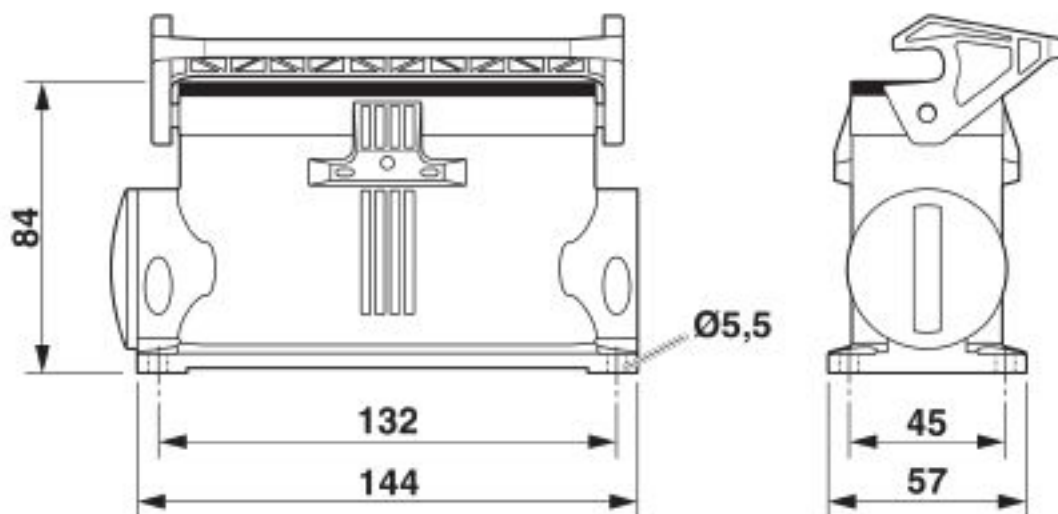

Dimensional drawing

## Classifications

eCl@ss

eCl@ss 10.0.1	27440202
eCl@ss 5.1	27261200
eCl@ss 6.0	27261200
eCl@ss 7.0	27440202

# Housing - HC-STA-B24-SHWS-2SSM40-ELC-AL - 1082593

## Classifications

### eCl@ss

eCl@ss 8.0	27440202
eCl@ss 9.0	27440202

### ETIM

ETIM 5.0	EC000437
ETIM 6.0	EC000437
ETIM 7.0	EC000437

### UNSPSC

UNSPSC 13.2	31261501
UNSPSC 18.0	31261501
UNSPSC 19.0	31261501
UNSPSC 20.0	31261501
UNSPSC 21.0	31261501

## Accessories

### Accessories

#### Full screw connection

Cable gland - G-INS-M40-M68N-NNES-S - 1411167



Cable gland, cable gland material: Nickel-plated brass, external cable diameter 19 mm ... 28 mm, shielding: no, connecting thread: M40 x 1.5, color: silver, with O-ring

Cable gland - G-INSEC-M40-M68N-NCRS-S - 1411192



Cable gland, cable gland material: Nickel-plated brass, external cable diameter 19 mm ... 27 mm, shielding: yes, connecting thread: M40 x 1.5, color: silver, with O-ring

### Housing latches

Replacement part - HC-STA-B24-SL-PLBK - 1412885



Single locking latch for B24 housing, HC-EVO....AL and HC-STA....AL

## Housing - HC-STA-B24-SHWS-2SSM40-ELC-AL - 1082593

### Accessories

#### Seal

Profile gasket - HC-B24-SP-CBK - 1411482



Profile gasket for HEAVYCON EVO supporting base element type B24, conductive

---

Phoenix Contact 2020 © - all rights reserved  
<http://www.phoenixcontact.com>

PHOENIX CONTACT GmbH & Co. KG  
Flachsmarktstr. 8  
32825 Blomberg  
Germany  
Tel. +49 5235 300  
Fax +49 5235 3 41200  
<http://www.phoenixcontact.com>

## X-ON Electronics

Largest Supplier of Electrical and Electronic Components

*Click to view similar products for [Heavy Duty Power Connectors](#) category:*

*Click to view products by [Phoenix Contact](#) manufacturer:*

Other Similar products are found below :

[647757-1](#) [6643411-1](#) [6646058-2](#) [6646137-1](#) [6646138-1](#) [6646479-1](#) [6646608-1](#) [6646786-1](#) [6646940-1](#) [6651091-1](#) [6651525-1](#) [6651529-1](#)  
[6651788-1](#) [696475-1](#) [702-32-01109](#) [703-25-02205](#) [73000005059](#) [73000005642](#) [73080255059](#) [73080965046](#) [765-15-0080A](#) [765-16-0080B](#)  
[765-18-0080D](#) [829992-1](#) [902-77-02113](#) [PS00/A0620/6300](#) [PS25/A0420/63](#) [129-1J](#) [1409400](#) [AN0024023](#) [E6374G1](#) [e6389g2](#) [157-43GW8](#)  
[MS3117-14AC](#) [1643543-1](#) [1650540-1](#) [1651811-2](#) [1766260-1](#) [1766282-1](#) [1766966-1](#) [1791340000](#) [NLDFT-3-BL-L-S120-M40A](#) [NLDFT-N-](#)  
[W-L-C240-M40B](#) [NLS-2-R-C240-M40B](#) [NLS-N-W-C240-M40B](#) [NPS-3-BL-T6](#) [1986615-1](#) [2-1589900-8](#) [2199314-1](#) [KA8102](#)