

Sensor/actuator cable - SAC-3P-10,0-PUR/CI-1L-R-ES - 1401617

Please be informed that the data shown in this PDF Document is generated from our Online Catalog. Please find the complete data in the user's documentation. Our General Terms of Use for Downloads are valid (<http://phoenixcontact.com/download>)



Sensor/actuator cable, 3-position, PUR halogen-free, black-gray RAL 7021, free cable end, on Valve connector CI (9.4 mm), with 1 LED, connected with Damping diode, cable length: 10 m, With holding current limiting device for energy reduction

Key Commercial Data

Packing unit	1 pc
GTIN	 4 046356 924702
GTIN	4046356924702

Technical data

Dimensions

Length of cable	10 m
Central screw valve connector	M3 x 25

Ambient conditions

Ambient temperature (operation)	-25 °C ... 80 °C (valve plug)
Degree of protection	IP67

General

Rated current at 40°C	1 A
Rated voltage	24 V DC ±20 %
Number of positions	3
Insulation resistance	≥ 100 MΩ
Status display	1 LED
Protective circuit/component	Freewheeling diode with holding current limiting device
Switch-over time	approx. 200 ms (Initial operating time)
Clock frequency	approx. 2500 Hz (Holding current limiting device)
Switching frequency	max. 5 Hz (Connected valve)

Material

Sensor/actuator cable - SAC-3P-10,0-PUR/CI-1L-R-ES - 1401617

Technical data

Material

Valve plug contact material	CuSn
Valve plug contact surface material	Ag
Valve plug contact insert material	PA 6.6
Material housing valve plug	TPU
Sealing material	TPU (Seal molded)

Standards and Regulations

Cable

Cable type	PUR halogen-free black
Cable type (abbreviation)	PUR
Cable abbreviation	Li9Y11Y-HF
UL AWM style	20549
Conductor cross section	3x 0.5 mm ²
AWG signal line	20
Conductor structure signal line	28x 0.15 mm
Core diameter including insulation	1.5 mm ±0.05 mm (Signal line)
Wire colors	black 1, black 2, green/yellow
Overall twist	3 wires, twisted
External sheath, color	black-gray RAL 7021
External cable diameter D	4.5 mm ±0.2 mm
Smallest bending radius, fixed installation	22.5 mm
Number of bending cycles	15000000
Bending radius	50 mm
Traversing path	0.9 m
Traversing rate	5 m/s
Acceleration	30 m/s ²
Outer sheath, material	PUR
Material conductor insulation	PP
Conductor material	Bare Cu litz wires
Insulation resistance	min. 20 MΩ*km
Conductor resistance	39 Ω/km (at 20 °C)
Nominal voltage, cable	≤ 300 V
Test voltage, cable	≥ 1200 V
Flame resistance	according to DIN VDE 0482
	According to DIN EN 50265-2-1
Halogen-free	in accordance with DIN VDE 0472 part 815
Other resistance	largely oil-resistant
	partly UV-resistant in accordance with DIN EN ISO 4892-2-A
Ambient temperature (operation)	-40 °C ... 80 °C (cable, fixed installation)
	-20 °C ... 80 °C (cable, flexible installation)

Sensor/actuator cable - SAC-3P-10,0-PUR/CI-1L-R-ES - 1401617

Technical data

Environmental Product Compliance

China RoHS	Environmentally friendly use period: unlimited = EFUP-e
	No hazardous substances above threshold values

Drawings

Schematic diagram

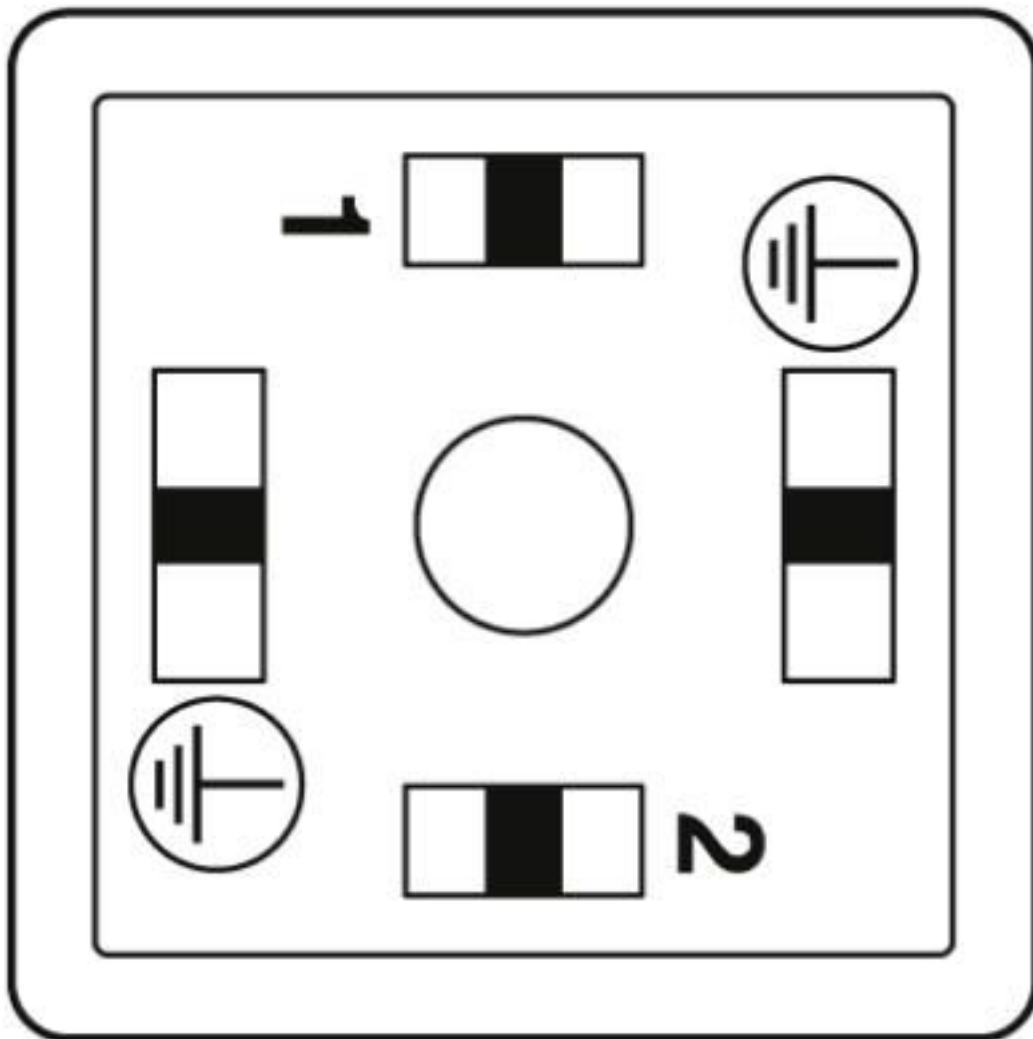

Valve connector connector pin assignment, type CI

Sensor/actuator cable - SAC-3P-10,0-PUR/CI-1L-R-ES - 1401617

Dimensional drawing

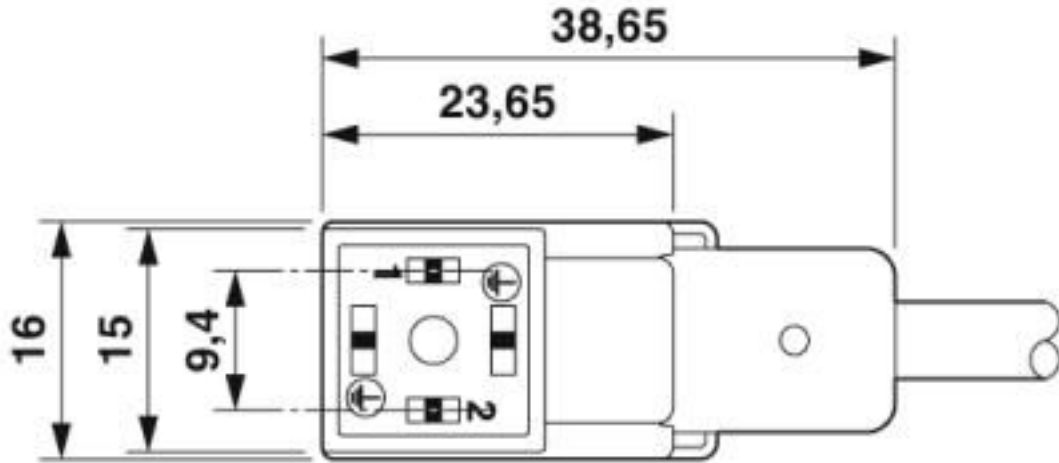

Valve connector, type CI

Dimensional drawing

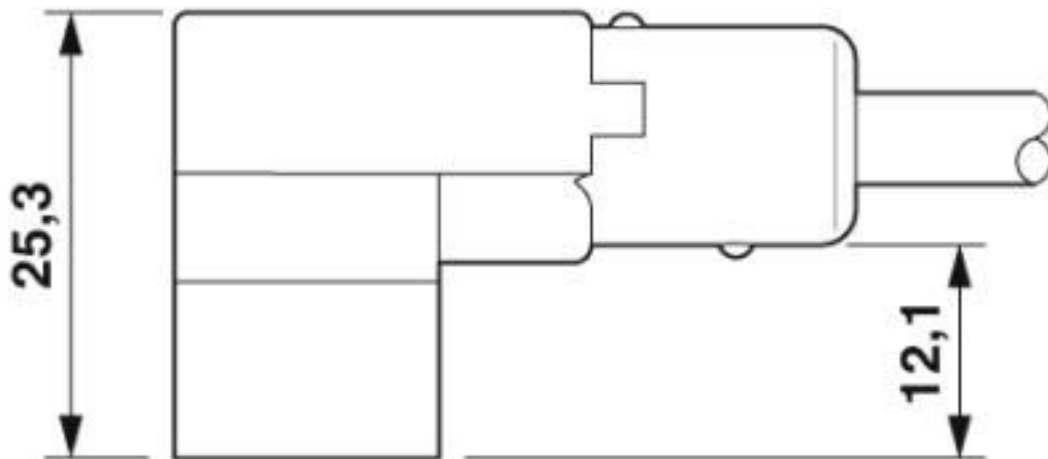

Valve connector, type CI, side view

Sensor/actuator cable - SAC-3P-10,0-PUR/CI-1L-R-ES - 1401617

Circuit diagram

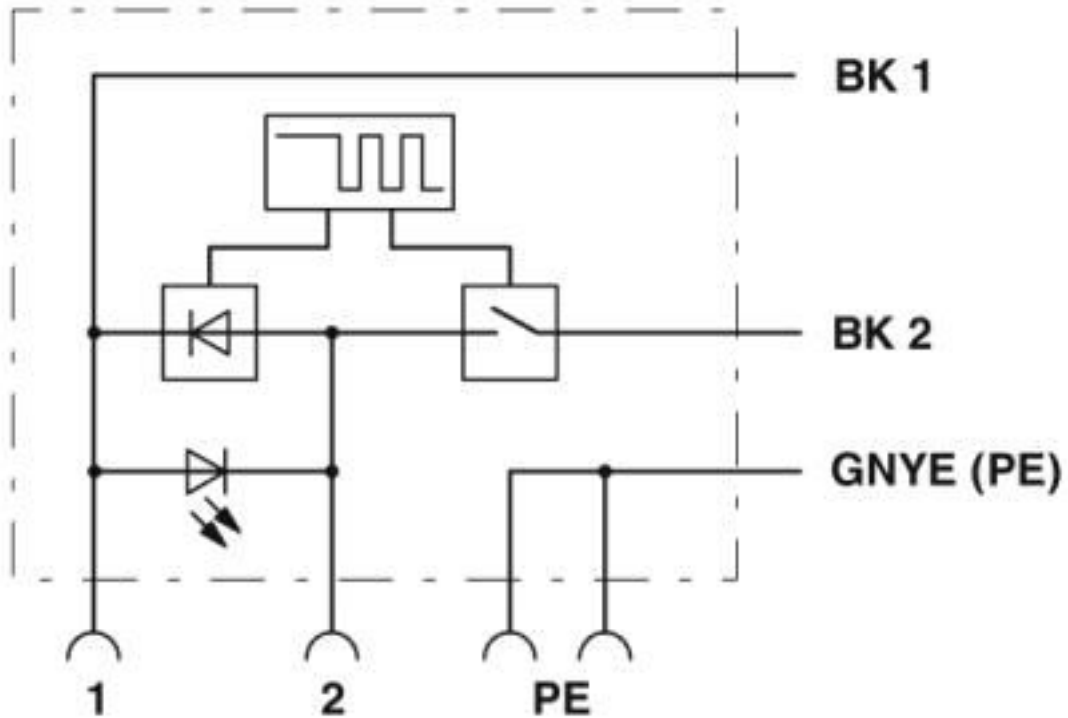

Contact assignment of the valve plug

Sensor/actuator cable - SAC-3P-10,0-PUR/CI-1L-R-ES - 1401617

Cable cross section

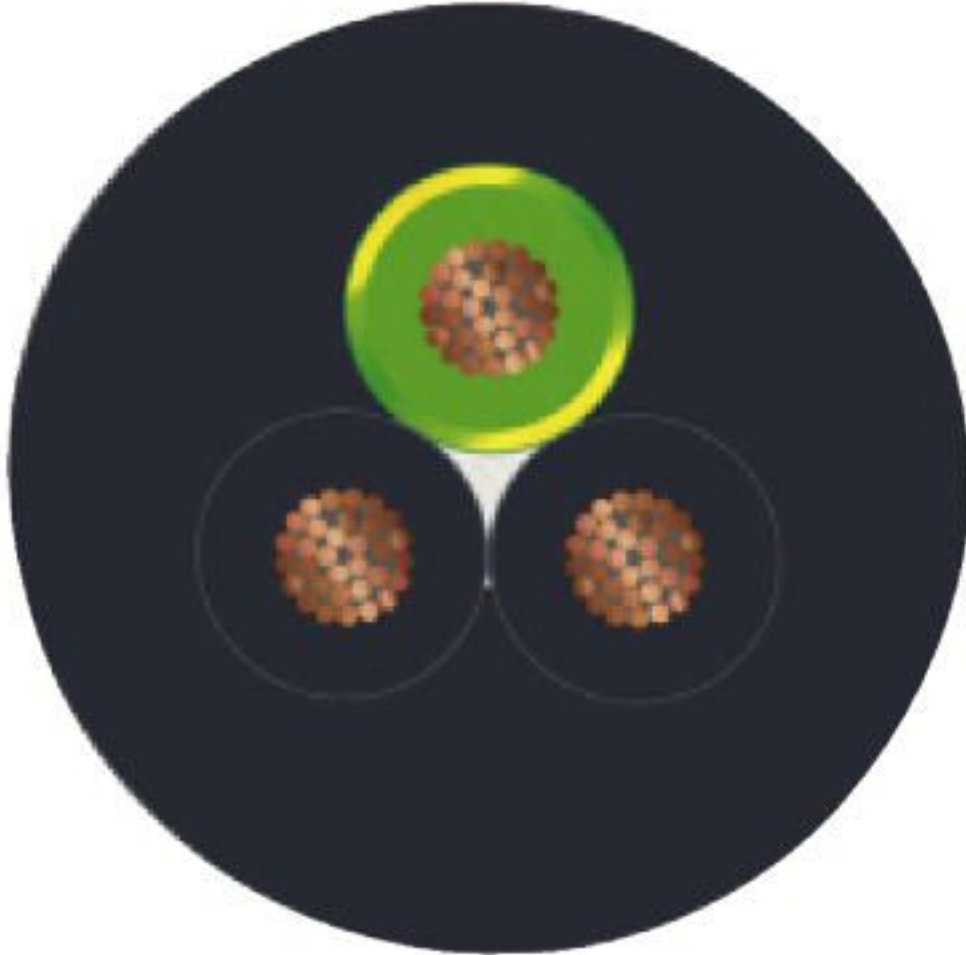

PUR halogen-free black [PUR]

Classifications

eCl@ss

eCl@ss 10.0.1	27060312
eCl@ss 4.0	27060300
eCl@ss 4.1	27060300
eCl@ss 5.0	27061800
eCl@ss 5.1	27061800
eCl@ss 6.0	27279200
eCl@ss 7.0	27279218
eCl@ss 8.0	27279218
eCl@ss 9.0	27060312

Sensor/actuator cable - SAC-3P-10,0-PUR/CI-1L-R-ES - 1401617

Classifications

ETIM

ETIM 4.0	EC001855
ETIM 5.0	EC001855
ETIM 6.0	EC001855
ETIM 7.0	EC001855

UNSPSC

UNSPSC 13.2	31251501
UNSPSC 19.0	31251501
UNSPSC 20.0	31251501
UNSPSC 21.0	31251501

Approvals

Approvals

Approvals

EAC-RoHS / EAC

Ex Approvals

Approval details

EAC-RoHS		RU D- DE.HB35.B.00387
----------	--	--------------------------

EAC		RU C- DE.BL08.B.00286
-----	--	--------------------------

Phoenix Contact 2020 © - all rights reserved
<http://www.phoenixcontact.com>

PHOENIX CONTACT GmbH & Co. KG
Flachsmarktstr. 8
32825 Blomberg
Germany
Tel. +49 5235 300
Fax +49 5235 3 41200
<http://www.phoenixcontact.com>

X-ON Electronics

Largest Supplier of Electrical and Electronic Components

Click to view similar products for [Sensor Cables / Actuator Cables](#) category:

Click to view products by [Phoenix Contact](#) manufacturer:

Other Similar products are found below :

[60963](#) [60964](#) [703000D02F2002](#) [703001D02F0602](#) [703001D02F300](#) [704000D02F120](#) [773032K02F030](#) [802027107404-1](#) [802027213811-1](#)
[804001A09M150](#) [805001A09M0502](#) [84914-0235](#) [84914-0237](#) [885030A09M020](#) [8R4J30E03C3003](#) [1200651332](#) [1200651713](#) [1200660844](#)
[1200660845](#) [1200661173](#) [1200680071](#) [1200720053](#) [1200720081](#) [1200720099](#) [1200720217](#) [1200800231](#) [1200860125](#) [1200870123](#)
[1200980102](#) [1200650267](#) [1200650298](#) [1200660183](#) [1200660782](#) [1200660849](#) [1200661295](#) [1200661297](#) [1200661342](#) [1200661343](#)
[1200670080](#) [1200670220](#) [1200680331](#) [1200720252](#) [1200730184](#) [1200860344](#) [1200870359](#) [1200870643](#) [1200980008](#) [1200980031](#)
[1210502211](#) [1210400542](#)