

Hybrid cable - VS-M12MS-94H-HYB/20,0 SCO - 1402447

Please be informed that the data shown in this PDF Document is generated from our Online Catalog. Please find the complete data in the user's documentation. Our General Terms of Use for Downloads are valid (<http://phoenixcontact.com/download>)



Hybrid cable, Ethernet hybrid CAT5 (100 Mbps), 8-position, Plug straight M12 SPEEDCON / IP67, coding: Y, on free cable end, cable length: 20 m, Power with Ethernet (PWE)



Ethernet

Key Commercial Data

Packing unit	1 pc
GTIN	
GTIN	4046356616041

Technical data

Dimensions

Length of cable	20 m
-----------------	------

Ambient conditions

Degree of protection	IP65
	IP67

General data

Rated current at 40°C	6 A (Power)
	0.5 A (Data)
Rated voltage	30 V AC (Power and data)
	30 V DC
Number of positions	8
Signal type/category	Ethernet hybrid CAT5 (IEC 11801), 100 Mbps
Degree of pollution	2
Degree of protection	IP67/IP69K
Transmission characteristics (category)	CAT5

Characteristics head 1

Head type	Plug straight M12 SPEEDCON / IP67
-----------	-----------------------------------

Hybrid cable - VS-M12MS-94H-HYB/20,0 SCO - 1402447

Technical data

Characteristics head 1

No. of positions (pin connector pattern)	8 (4+4)
Coding	Y (Hybrid)
Color	black
Material (component)	CuZn (Contact)
	Ni/Au (Contact surface)
	PP (Contact carrier, data)
	PA (Contact carrier, power)
	TPU, hardly inflammable, self-extinguishing (Grip)
	Zinc die-cast, nickel-plated (Screw connection)
Shielded	yes
Insulation resistance	≥ 100 MΩ
Insertion/withdrawal cycles	≥ 100
Torque	0.4 Nm
Ambient temperature (operation)	-25 °C ... 90 °C
Shielded	yes
Type type, plug side	Plug straight
Type type, socket side	free cable end

Characteristics head 2

Head type	free cable end
No. of positions (pin connector pattern)	8
Color	black
Shielded	yes

Standards and Regulations

Flammability rating according to UL 94	V0
--	----

Cable

Cable type	Ethernet hybrid
Cable type (abbreviation)	94H
UL AWM style	20963 (80°C/30 V)
Signal type/category	Ethernet hybrid CAT5 (IEC 11801), 100 Mbps
Cable structure	1x4xAWG26+1x4xAWG20
Conductor cross section	4x 0.15 mm ² (Data)
	4x 0.6 mm ² (Power)
AWG signal line	26
AWG power supply	20
Conductor structure signal line	19x 0.10 mm
Conductor structure, voltage supply	19x 0.20 mm
Core diameter including insulation	1.05 mm (Data)
	1.4 mm (Power)
Wire colors	White/orange, orange, white/green, green, white, blue, brown, black

Hybrid cable - VS-M12MS-94H-HYB/20,0 SCO - 1402447

Technical data

Cable

Overall twist	1 star quad and 4 wires with 2 fillers
Shielding	Tinned copper braided shield
Optical shield covering	85 %
External sheath, color	black RAL 9005
External cable diameter D	7.6 mm ±0.2 mm
Minimum bending radius, fixed installation	5 x D
Minimum bending radius, flexible installation	10 x D
Number of bending cycles	2000000
Minimum bending radius, drag chain applications	10 x D
Traversing path	4.5 m
Traversing rate	3 m/s
Acceleration	3 m/s ²
Tensile strength GRP	70 N (in accordance with DIN EN 50565-1 for flexible installation)
	240 N (in accordance with DIN EN 50565-1 for fixed installation)
Cable weight	87 kg/km
Outer sheath, material	PUR
Material conductor insulation	PP (Data)
	PP (Power)
Conductor material	Bare Cu litz wires
Insulation resistance	≥ 5 GΩ*km
Loop resistance	≤ 280.00 Ω/km (Data)
	≤ 34.60 Ω/km (Power)
Working capacitance	nom. 50 nF (per kilometer)
Wave impedance	100 Ω ±15 Ω (4 MHz ... 100 MHz)
Near end crosstalk attenuation (NEXT)	56.3 dB (at 4 MHz)
	50.3 dB (at 10 MHz)
	47.2 dB (at 16 MHz)
	45.8 dB (at 20 MHz)
	42.9 dB (at 31.25 MHz)
	38.4 dB (at 62.5 MHz)
	35.3 dB (at 100 MHz)
Attenuation	6 dB (at 4 MHz)
	9.5 dB (at 10 MHz)
	12.1 dB (at 16 MHz)
	13.5 dB (at 20 MHz)
	17.1 dB (at 31.25 MHz)
	24.8 dB (at 62.5 MHz)
	32 dB (at 100 MHz)
Shield attenuation	≥ 80 dB (30 MHz ... 125 MHz)
Differential impedance	100 Ω ±5 % (at 100 MHz)

Hybrid cable - VS-M12MS-94H-HYB/20,0 SCO - 1402447

Technical data

Cable

Nominal voltage, cable	≤ 50 V (Peak value, not for high-power applications)
Test voltage Core/Core	1500 V (50 Hz, 1 min.)
Test voltage Core/Shield	1500 V (50 Hz, 1 min.)
Special properties	Free of substances which would hinder coating with paint or varnish
	Silicone-free
Flame resistance	in acc. with UL 1581, section 1061
Halogen-free	according to IEC 60754
	in accordance with DIN VDE 0472 part 815
Resistance to oil	according to IEC 60811-2-1
	according to VDE 0282 Part 10
Other resistance	Low adhesion
Ambient temperature (operation)	-40 °C ... 90 °C (cable, fixed installation)
	-30 °C ... 70 °C (cable, flexible installation)

Environmental Product Compliance

REACH SVHC	Lead 7439-92-1
China RoHS	Environmentally Friendly Use Period = 50 years
	For details about hazardous substances go to tab "Downloads", Category "Manufacturer's declaration"

Drawings

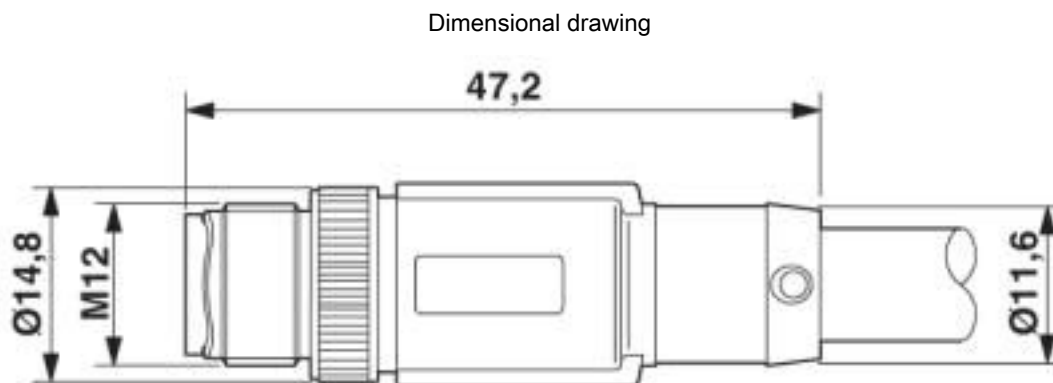

M12 connector, straight, shielded

Hybrid cable - VS-M12MS-94H-HYB/20,0 SCO - 1402447

Circuit diagram

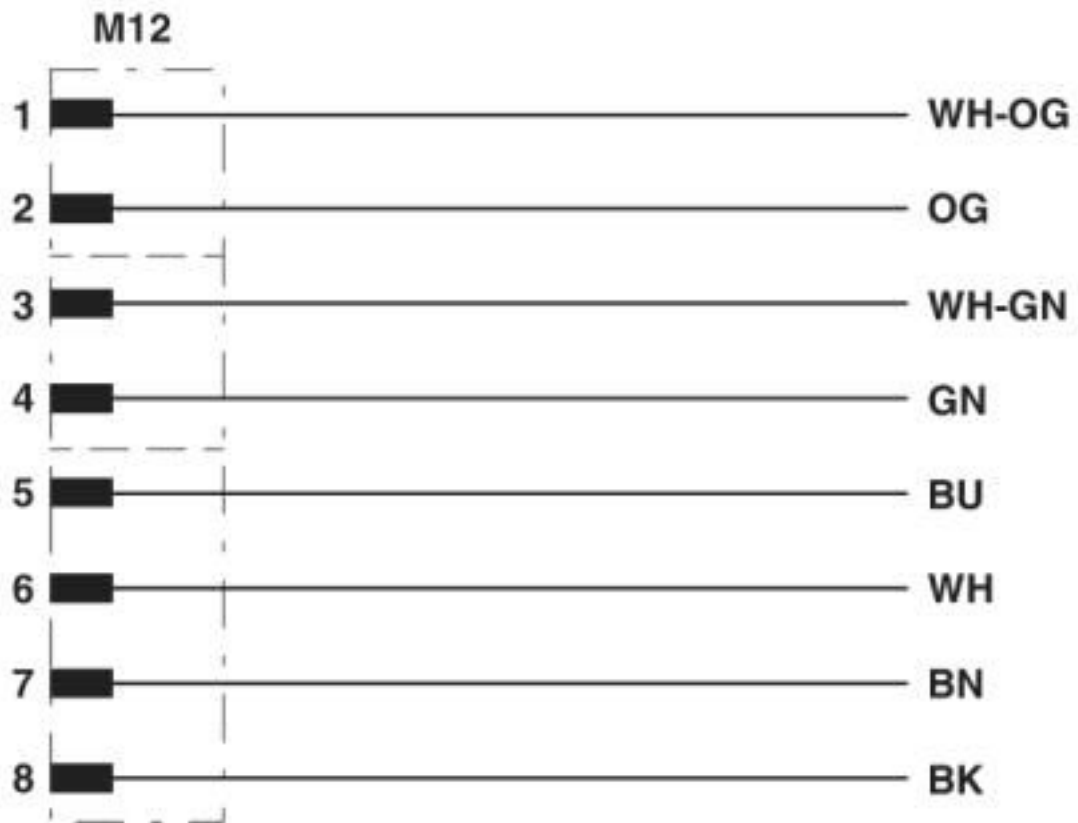

Hybrid cable - VS-M12MS-94H-HYB/20,0 SCO - 1402447

Schematic diagram

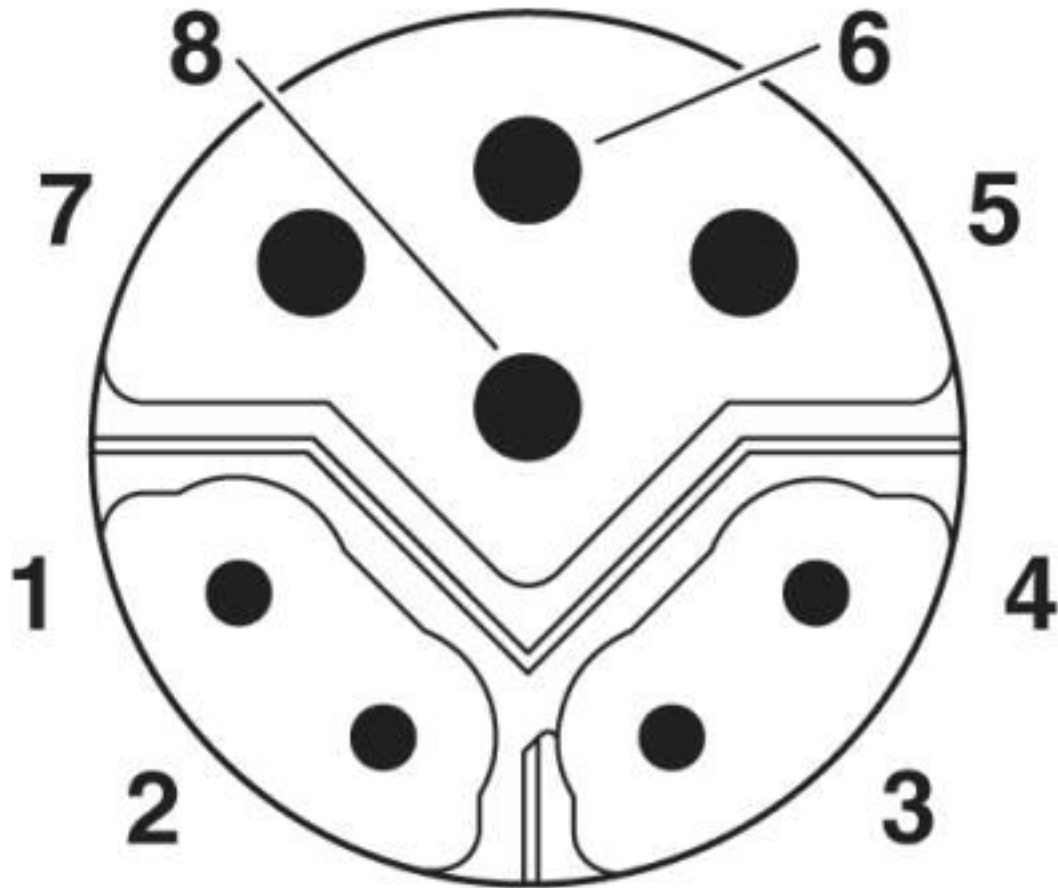

M12 hybrid connector pin assignment, 8-pos., pin side view

Hybrid cable - VS-M12MS-94H-HYB/20,0 SCO - 1402447

Cable cross section



Ethernet hybrid [94H]

Classifications

eCl@ss

eCl@ss 10.0.1	27060308
eCl@ss 4.0	27260700
eCl@ss 4.1	27260700
eCl@ss 5.0	27259200
eCl@ss 5.1	27259200
eCl@ss 6.0	27279200
eCl@ss 7.0	27279218
eCl@ss 8.0	27279218
eCl@ss 9.0	27060308

Hybrid cable - VS-M12MS-94H-HYB/20,0 SCO - 1402447

Classifications

ETIM

ETIM 4.0	EC002599
ETIM 5.0	EC002599
ETIM 6.0	EC001262
ETIM 7.0	EC001262

UNSPSC

UNSPSC 6.01	26121616
UNSPSC 7.0901	26121616
UNSPSC 11	26121604
UNSPSC 12.01	26121616
UNSPSC 13.2	31251501
UNSPSC 18.0	26121604
UNSPSC 19.0	26121604
UNSPSC 20.0	26121604
UNSPSC 21.0	26121604

Approvals

Approvals

Approvals

UL Listed / cUL Listed / EAC-RoHS / cULus Listed

Ex Approvals

Approval details

UL Listed		http://database.ul.com/cgi-bin/XYV/template/LISEXT/1FRAME/index.htm	FILE E 335024
Nominal voltage UN	56.5 V		
Nominal current IN	0.175 A		

cUL Listed		http://database.ul.com/cgi-bin/XYV/template/LISEXT/1FRAME/index.htm	FILE E 335024
Nominal voltage UN	56.5 V		
Nominal current IN	0.175 A		

Hybrid cable - VS-M12MS-94H-HYB/20,0 SCO - 1402447

Approvals

EAC-RoHS		RU D- DE.HB35.B.00385
----------	---	--------------------------

cULus Listed		
--------------	---	--

Phoenix Contact 2020 © - all rights reserved
<http://www.phoenixcontact.com>

PHOENIX CONTACT GmbH & Co. KG
Flachsmarktstr. 8
32825 Blomberg
Germany
Tel. +49 5235 300
Fax +49 5235 3 41200
<http://www.phoenixcontact.com>

X-ON Electronics

Largest Supplier of Electrical and Electronic Components

Click to view similar products for [Ethernet Cables / Networking Cables](#) category:

Click to view products by [Phoenix Contact](#) manufacturer:

Other Similar products are found below :

[73-6670-7](#) [73-6680-15](#) [73-7797-25](#) [MCJB2-10P6Q7-120](#) [84909-0204](#) [1200700174](#) [1200860368](#) [E16A06002M030](#) [E200102-009-S1](#)
[AX105346-EW](#) [MT14-187L](#) [17-103530](#) [ERWPAB3002M005](#) [190-038045-01](#) [NK5EPC18RDY](#) [NK5EPC18VLY](#) [NK5EPC18YLY](#)
[NK5EPC1GRY](#) [NK5EPC4Y](#) [NK5EPC6YLY](#) [NK5EPC8BLY](#) [NK5EPC9YLY](#) [1969343-6](#) [C501100010](#) [C501106002](#) [C501106007](#)
[C501106015](#) [C501106025](#) [C601102010](#) [C601104010](#) [C601106007](#) [C601106015](#) [2142758-2](#) [2168427-2](#) [CAT1106007](#) [21949-1](#) [2J1866A](#)
[RJF SFTP 5E 0500](#) [AX100351](#) [MN14CEC/ST](#) [C501100015](#) [C501106004](#) [C501106010](#) [C5F1108007](#) [C601104004](#) [C601106004](#)
[CA21106004](#) [CA21106010](#) [CA21106015](#) [CA21109007](#)