

Patch cable - VS-PNRJ45R-PNRJ45R-93K-2,0 - 1402518

Please be informed that the data shown in this PDF Document is generated from our Online Catalog. Please find the complete data in the user's documentation. Our General Terms of Use for Downloads are valid (<http://phoenixcontact.com/download>)



Sercos III patch cable, shielded, star quad, AWG 22 stranded (7-wire), RAL 3020 (traffic red), RJ45 connector/IP 20, angled, to RJ45 connector/IP20, angled, length: 2.0 m

Sercos III patch cable



Key Commercial Data

Packing unit	1 pc
GTIN	 4 046356 622578
GTIN	4046356622578

Technical data

Dimensions

Length of cable	2.00 m
-----------------	--------

Ambient conditions

Degree of protection	IP20
----------------------	------

General data

Number of positions	4
Overvoltage category	I
Degree of pollution	1
Locking type	Push Pull
Rated voltage (III/3)	72 V (DC)
Degree of protection	IP20

Characteristics head 1

Color	black
Material (component)	CuSn (Contact)
	Ni/Au (Contact surface)
	PA (Contact carriers)
	PA (Housing)

Patch cable - VS-PNRJ45R-PNRJ45R-93K-2,0 - 1402518

Technical data

Characteristics head 1

Insertion/withdrawal cycles	≥ 750
Ambient temperature (operation)	-25 °C ... 80 °C
Shielded	yes

Characteristics head 2

Color	black
Material (component)	CuSn (Contact)
	Ni/Au (Contact surface)
	PA (Contact carriers)
	PA (Housing)
Insertion/withdrawal cycles	≥ 750
Ambient temperature (operation)	-25 °C ... 80 °C

Standards and Regulations

Flammability rating according to UL 94	V0
--	----

Cable

Cable type	Sercos III
Cable type (abbreviation)	93K
UL AWM style	21694 (60°C / 600 V)
Signal type/category	Sercos CAT5 (IEC 11801), 100 Mbps
Cable structure	1x4xAWG22/7; SF/TQ
Conductor cross section	4x 0.34 mm ²
AWG signal line	22
Conductor structure signal line	7x 0.25 mm
Core diameter including insulation	approx. 1.55 mm
Wire colors	White, yellow, blue, orange
Type of pair shielding	Aluminum-lined polyester foil
Overall twist	Star quad
Shielding	Tinned copper braided shield
External sheath, color	signal red RAL 3020
Outer sheath thickness	approx. 0.9 mm
External cable diameter D	6.5 mm ±0.2 mm
Minimum bending radius, fixed installation	3 x D
Minimum bending radius, flexible installation	7 x D
Cable weight	68 kg/km
Outer sheath, material	PVC
Material, inner sheath	PVC
Material conductor insulation	PE
Conductor material	Tin-plated Cu litz wires
Insulation resistance	≥ 0.5 GΩ*km
Conductor resistance	≤ 120 Ω/km

Patch cable - VS-PNRJ45R-PNRJ45R-93K-2,0 - 1402518

Technical data

Cable

Wave impedance	100 Ω ±15 Ω (at 100 MHz)
Signal runtime	5.3 ns/m
Coupling resistance	≤ 20.00 mΩ/m (at 10 Hz)
Nominal voltage, cable	600 V
Test voltage Core/Core	2000 V (50 Hz, 1 min.)
Test voltage Core/Shield	2000 V (50 Hz, 1 min.)
Flame resistance	according to UL 1685 (CSA FT 4)
Resistance to oil	Resistant to oil to a limited extent
Other resistance	UV resistant According to UL 1581, Section 1200
Ambient temperature (operation)	-40 °C ... 70 °C (cable, fixed installation)
	-40 °C ... 70 °C (cable, flexible installation)
Ambient temperature (installation)	-20 °C ... 60 °C
Ambient temperature (storage/transport)	-50 °C ... 70 °C

Environmental Product Compliance

China RoHS	Environmentally friendly use period: unlimited = EFUP-e
	No hazardous substances above threshold values

Drawings

Dimensional drawing

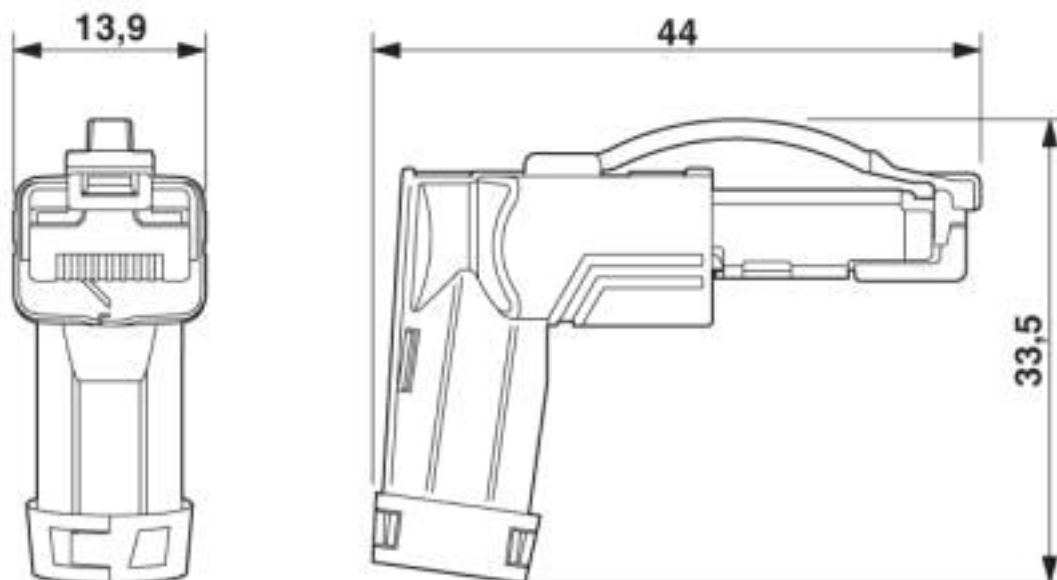

RJ45 connector, IP20, angled

Patch cable - VS-PNRJ45R-PNRJ45R-93K-2,0 - 1402518

Circuit diagram

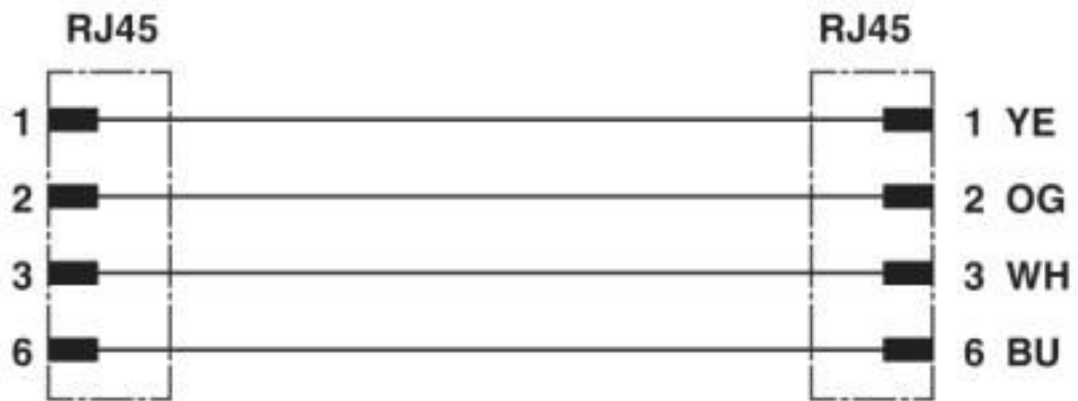

Cable cross section

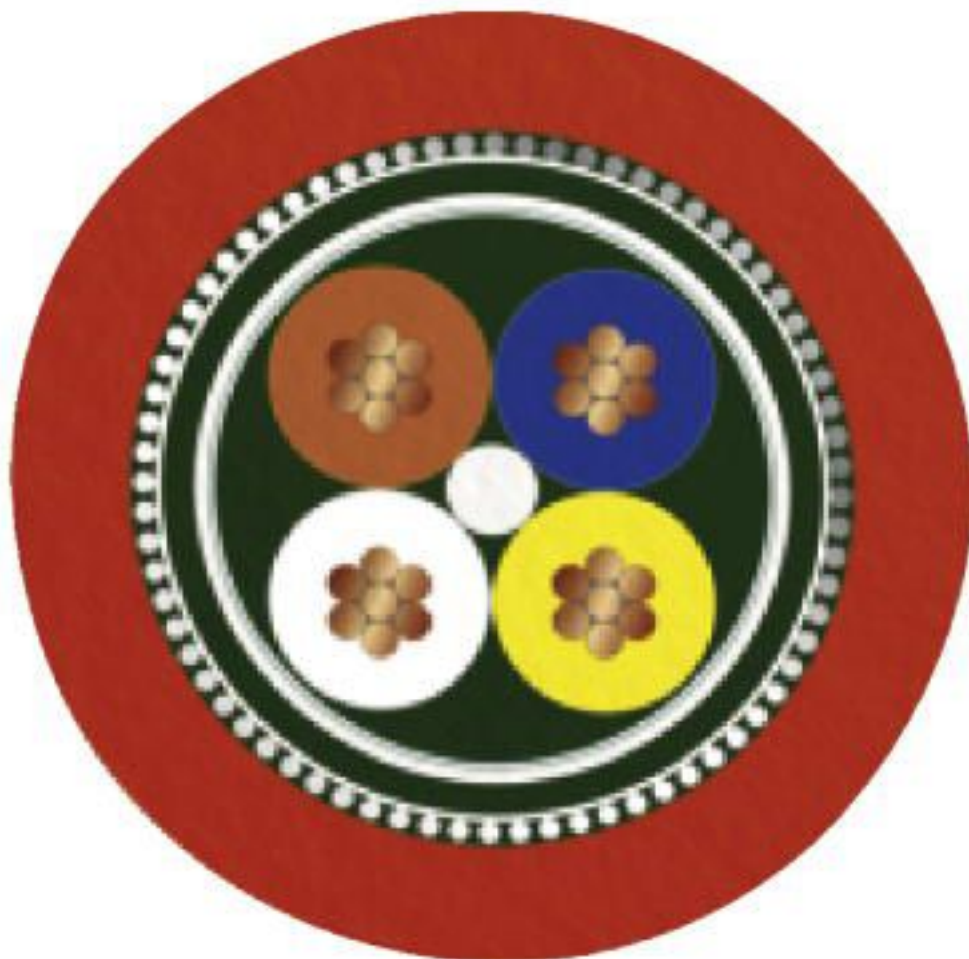

Patch cable - VS-PNRJ45R-PNRJ45R-93K-2,0 - 1402518

Classifications

eCl@ss

eCl@ss 10.0.1	27060308
eCl@ss 4.0	24010400
eCl@ss 4.1	24010400
eCl@ss 5.0	19030300
eCl@ss 5.1	19030300
eCl@ss 6.0	27061800
eCl@ss 7.0	27060308
eCl@ss 8.0	27060308
eCl@ss 9.0	27060308

ETIM

ETIM 4.0	EC002599
ETIM 5.0	EC002599
ETIM 6.0	EC001262
ETIM 7.0	EC001262

UNSPSC

UNSPSC 6.01	26121616
UNSPSC 7.0901	26121616
UNSPSC 11	26121604
UNSPSC 12.01	31261501
UNSPSC 13.2	26121604
UNSPSC 18.0	26121604
UNSPSC 19.0	26121604
UNSPSC 20.0	26121604
UNSPSC 21.0	26121604

Approvals

Approvals

Approvals

EAC

Ex Approvals

Approval details

Patch cable - VS-PNRJ45R-PNRJ45R-93K-2,0 - 1402518

Approvals

EAC		19060508
-----	---	----------

Phoenix Contact 2020 © - all rights reserved
<http://www.phoenixcontact.com>

PHOENIX CONTACT GmbH & Co. KG
Flachsmarktstr. 8
32825 Blomberg
Germany
Tel. +49 5235 300
Fax +49 5235 3 41200
<http://www.phoenixcontact.com>

X-ON Electronics

Largest Supplier of Electrical and Electronic Components

Click to view similar products for [Ethernet Cables / Networking Cables](#) category:

Click to view products by [Phoenix Contact](#) manufacturer:

Other Similar products are found below :

[73-6670-7](#) [73-6680-15](#) [73-7797-25](#) [MCJB2-10P6Q7-120](#) [84909-0204](#) [1200700174](#) [1200860368](#) [E16A06002M030](#) [E200102-009-S1](#)
[AX105346-EW](#) [MT14-187L](#) [17-103530](#) [ERWPAB3002M005](#) [190-038045-01](#) [NK5EPC18RDY](#) [NK5EPC18VLY](#) [NK5EPC18YLY](#)
[NK5EPC1GRY](#) [NK5EPC4Y](#) [NK5EPC6YLY](#) [NK5EPC8BLY](#) [NK5EPC9YLY](#) [1969343-6](#) [C501100010](#) [C501106002](#) [C501106007](#)
[C501106015](#) [C501106025](#) [C601102010](#) [C601104010](#) [C601106007](#) [C601106015](#) [2142758-2](#) [2168427-2](#) [CAT1106007](#) [21949-1](#) [2J1866A](#)
[RJF SFTP 5E 0500](#) [AX100351](#) [MN14CEC/ST](#) [C501100015](#) [C501106004](#) [C501106010](#) [C5F1108007](#) [C601104004](#) [C601106004](#)
[CA21106004](#) [CA21106010](#) [CA21106015](#) [CA21109007](#)