

Network cable - VS-M12FSBP-M12MS-936-LI/1,55 - 1403383

Please be informed that the data shown in this PDF Document is generated from our Online Catalog. Please find the complete data in the user's documentation. Our General Terms of Use for Downloads are valid (<http://phoenixcontact.com/download>)



Network cable, PROFINET CAT5 (100 Mbps), 4-position, PE-X, black RAL 9005, shielded, Plug straight M12 SPEEDCON / IP67, coding: D, on Flush-type socket straight M12 / IP67, coding: D, cable length: 1.55 m



Key Commercial Data

Packing unit	1 pc
Minimum order quantity	50 pc
GTIN	 4 046356 650168
GTIN	4046356650168

Technical data

Dimensions

Length of cable	1.55 m
-----------------	--------

Ambient conditions

Degree of protection	IP65
	IP67
Ambient temperature (operation)	-25 °C ... 90 °C (Plug / socket)
	-40 °C ... 90 °C (cable, fixed installation)
	-25 °C ... 90 °C (cable, flexible installation)

General data

Rated current at 40°C	4 A
Rated voltage	250 V
Number of positions	4
Signal type/category	PROFINET CAT5 (IEC 11801), 100 Mbps
Standards/regulations	M12 connector IEC 61076-2-101
Overvoltage category	II
Degree of protection	IP67
Transmission characteristics (category)	CAT5

Network cable - VS-M12FSBP-M12MS-936-LI/1,55 - 1403383

Technical data

Characteristics head 1

Head type	Plug straight M12 SPEEDCON / IP67
No. of positions (pin connector pattern)	4
Coding	D (Data)
Color	black
Material (component)	CuSn (Contact)
	Ni/Au (Contact surface)
	PA (Contact carriers)
	TPU, hardly inflammable, self-extinguishing (Grip)
	Zinc die-cast, nickel-plated (Screw connection)
Insulation resistance	≥ 100 MΩ
Insertion/withdrawal cycles	≥ 100
Torque	0.4 Nm
Ambient temperature (operation)	-25 °C ... 90 °C
Outer sheath, material	PE-X
External sheath, color	black RAL 9005

Characteristics head 2

Head type	Flush-type socket straight M12 / IP67
No. of positions (pin connector pattern)	4
Coding	D (Data)
Material (component)	CuZn (Contact)
	Ni/Au (Contact surface)
	PA 6.6 (Contact carriers)
	FKM (O-ring)
	Zinc die-cast, nickel-plated (Housing)
Insertion/withdrawal cycles	≥ 100
Ambient temperature (operation)	-40 °C ... 85 °C

Standards and Regulations

Standards/specifications	M12 connector IEC 61076-2-101
--------------------------	-------------------------------

Cable

Cable type	PROFINET RADOX® railway application CAT5 reinforced
Cable type (abbreviation)	936
Signal type/category	PROFINET CAT5 (IEC 11801), 100 Mbps
Cable structure	1x4xAWG22/7; SF/TQ
Conductor cross section	4x 0.34 mm ²
AWG signal line	22
Conductor structure signal line	7x 0.25 mm
Core diameter including insulation	1.95 mm
Wire colors	white-blue, orange-yellow
Overall twist	Star quad

Network cable - VS-M12FSBP-M12MS-936-LI/1,55 - 1403383

Technical data

Cable

Shielding	Plastic-coated aluminum foil, tinned copper braided shield
Optical shield covering	100 %
External sheath, color	black RAL 9005
Outer sheath thickness	≥ 0.8 mm
External cable diameter D	7.25 mm ±0.3 mm
Minimum bending radius, fixed installation	6 x D
Minimum bending radius, flexible installation	10 x D
Cable weight	81 g/m
Outer sheath, material	PE-X
Material conductor insulation	PE-X
Conductor material	silver-plated Cu litz wires
Conductor resistance	≤ 54.4 Ω/km
Working capacitance	≤ 65 pF (core-core) ≤ 100 pF (core-shield)
Wave impedance	100 Ω ±5 Ω (f = 100 MHz)
Near end crosstalk attenuation (NEXT)	80 dB (with 1 MHz) 76 dB (at 4 MHz) 67 dB (at 10 MHz) 60 dB (at 31.5 MHz) 56 dB (at 62.5 MHz) 53 dB (at 100 MHz)
Remote crosstalk attenuation (FEXT)	80 dB (with 1 MHz) 70 dB (at 4 MHz) 65 dB (at 10 MHz) 58 dB (at 31.5 MHz) 59 dB (at 62.5 MHz) 67 dB (at 100 MHz)
Attenuation	2 dB (with 1 MHz) 4 dB (at 4 MHz) 6.5 dB (at 10 MHz) 10.5 dB (at 31.5 MHz) 14 dB (at 62.5 MHz) 18 dB (at 100 MHz)
Return loss (RL)	35 dB (at 4 MHz) 35 dB (at 10 MHz) 35 dB (at 31.5 MHz) 33 dB (at 62.5 MHz) 33 dB (at 100 MHz)
Signal speed	66 c
Shield attenuation	40 dB (30 MHz ≤ f ≤ 100 MHz)

Network cable - VS-M12FSBP-M12MS-936-LI/1,55 - 1403383

Technical data

Cable

Coupling resistance	200.00 mΩ/m (f ≤ 30 MHz)
Nominal voltage, cable	300 V AC
Test voltage, cable	2000 V AC (50 Hz, 5 minutes)
Fire protection in rail vehicles	BS 6853 (Category Ia, Ib, II)
	GM/RT 2130 (Category Ia, Ib, II)
	EN 45545 (Risk level HL1 - HL3)
	DIN 5510 (Fire protection level 1, 2, 3, 4)
	NF F16-101 (Category A1, A2, B)
	NF F16-101 (Class C/F0)
	NFPA 130
	UNI CEI 11170 (Risk level LR1 - LR4)
Flame resistance	EN 60332-1-2
	EN 50266
	EN 60332-3-25
	NF C32-070, 2.1
	NF C32-070, 2.2
	UL 1685, 12 (FT4)
	in accordance with ISO 6722-1 5.22 (UN ECE-R 118.01)
Halogen-free	According to EN 50267-2-1
Resistance to oil	according to IRM 902, 72 h at 100 °C
Other resistance	Resistance to fuels according to IRM 903, 168 h at 70 °C
Concentration of fumes	BS 6853 D.8.7
	EN 61034-2
	UL 1685, 12 (FT4)
Fume corrosiveness	EN 50267-2-2
Fume toxicity	BS 6853 B.1
	EN 50305, 9.2
Ambient temperature (operation)	-50 °C ... 90 °C (cable, fixed installation)
	-40 °C ... 90 °C (cable, flexible installation)

Environmental Product Compliance

REACH SVHC	Lead 7439-92-1
China RoHS	Environmentally Friendly Use Period = 50 years
	For details about hazardous substances go to tab "Downloads", Category "Manufacturer's declaration"

Drawings

Network cable - VS-M12FSBP-M12MS-936-LI/1,55 - 1403383

Dimensional drawing

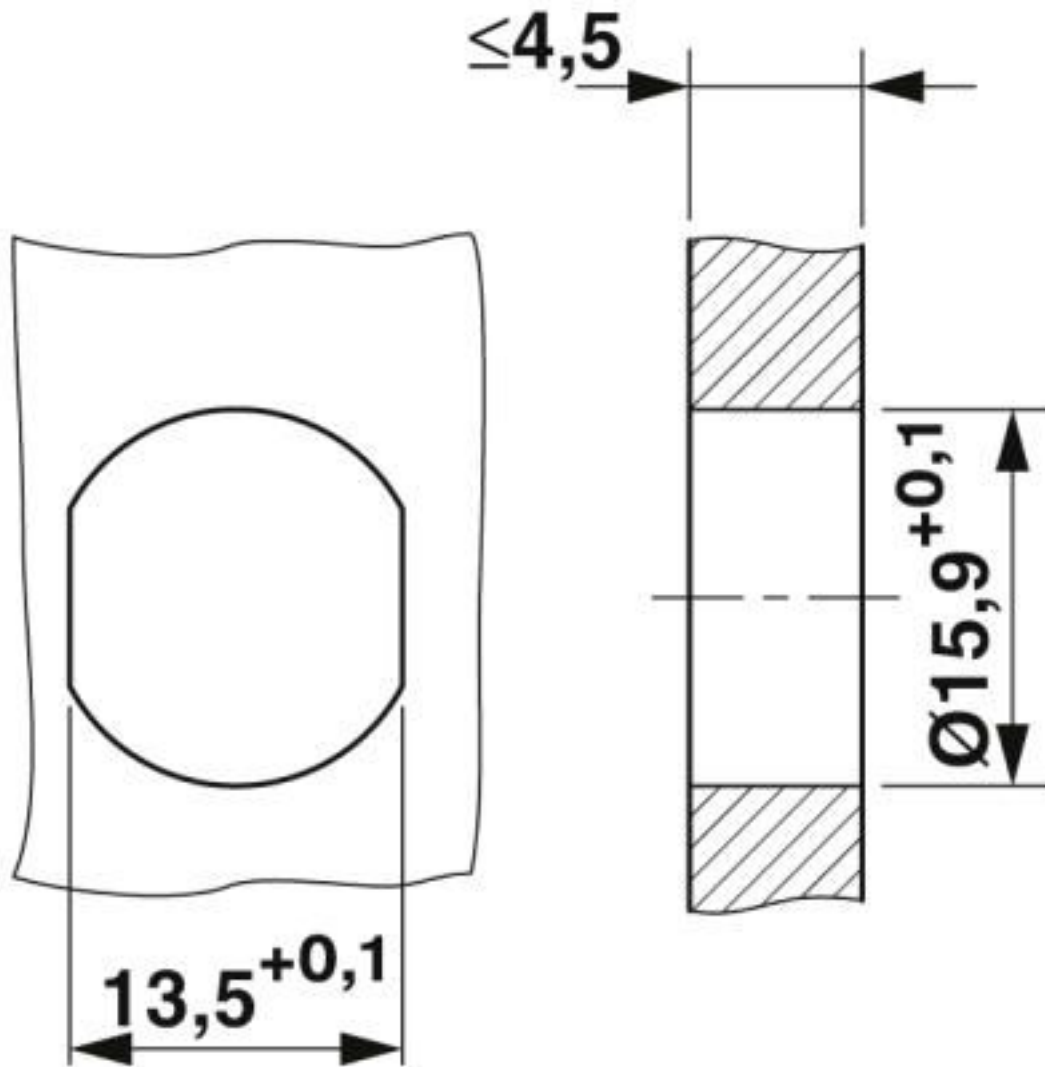

Housing cutout for M16 fastening thread, mounting panel with feed-through hole (alternatively with surface as protection against rotation)

Network cable - VS-M12FSBP-M12MS-936-LI/1,55 - 1403383

Dimensional drawing

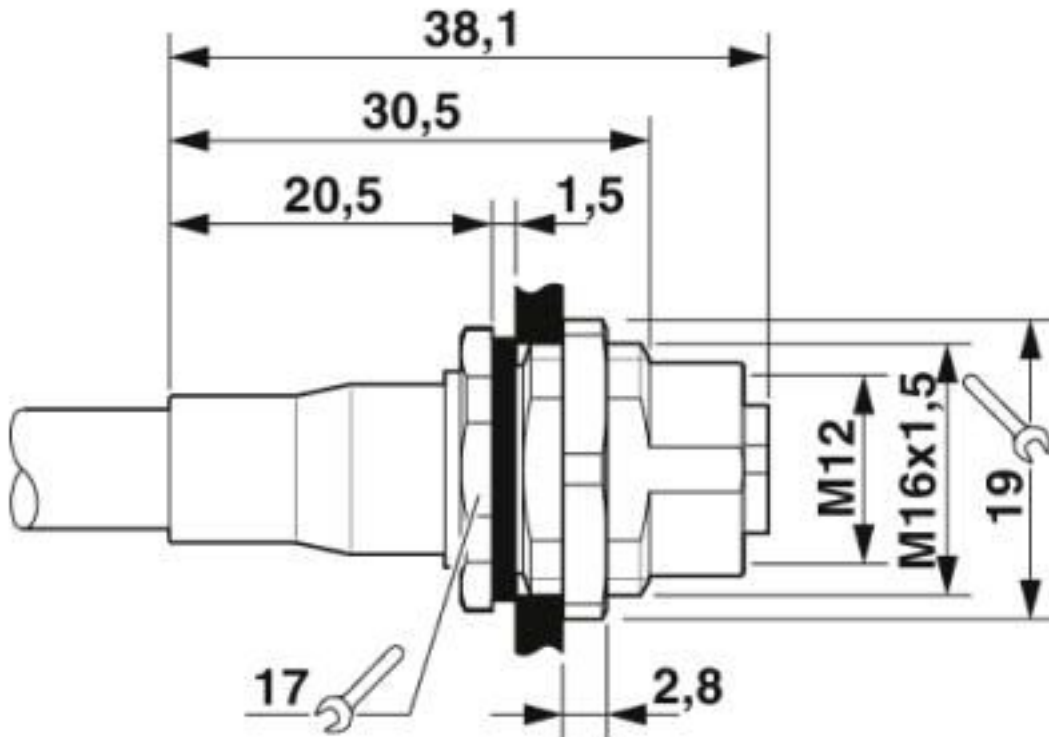

M12 flush-type connector

Dimensional drawing

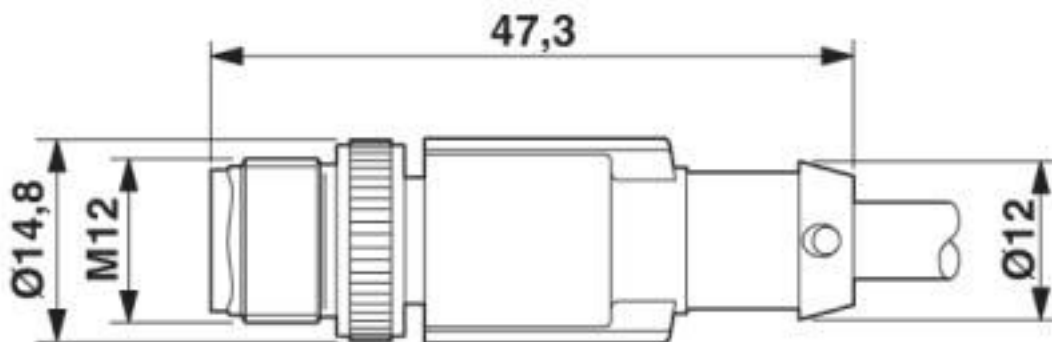

Plug, M12 x 1, straight, shielded

Network cable - VS-M12FSBP-M12MS-936-LI/1,55 - 1403383

Circuit diagram

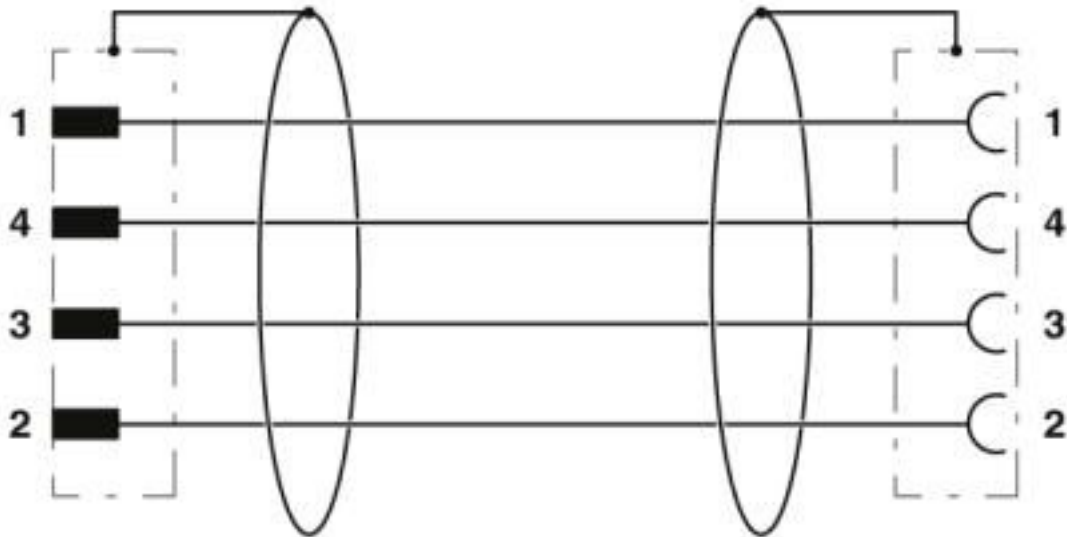

Contact assignment of the M12 plugs

Network cable - VS-M12FSBP-M12MS-936-LI/1,55 - 1403383

Schematic diagram

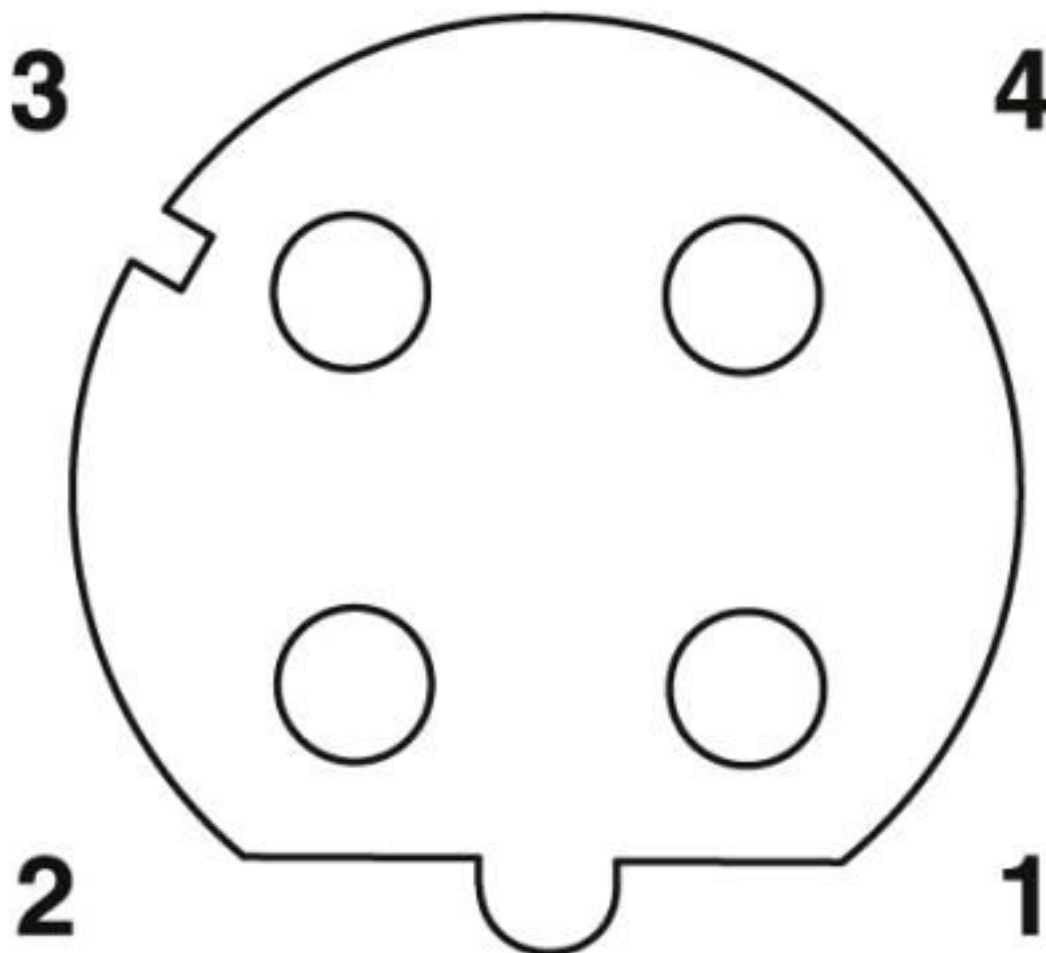

Pin assignment M12 socket, 4-pos., D-coded, female side

Network cable - VS-M12FSBP-M12MS-936-LI/1,55 - 1403383

Schematic diagram

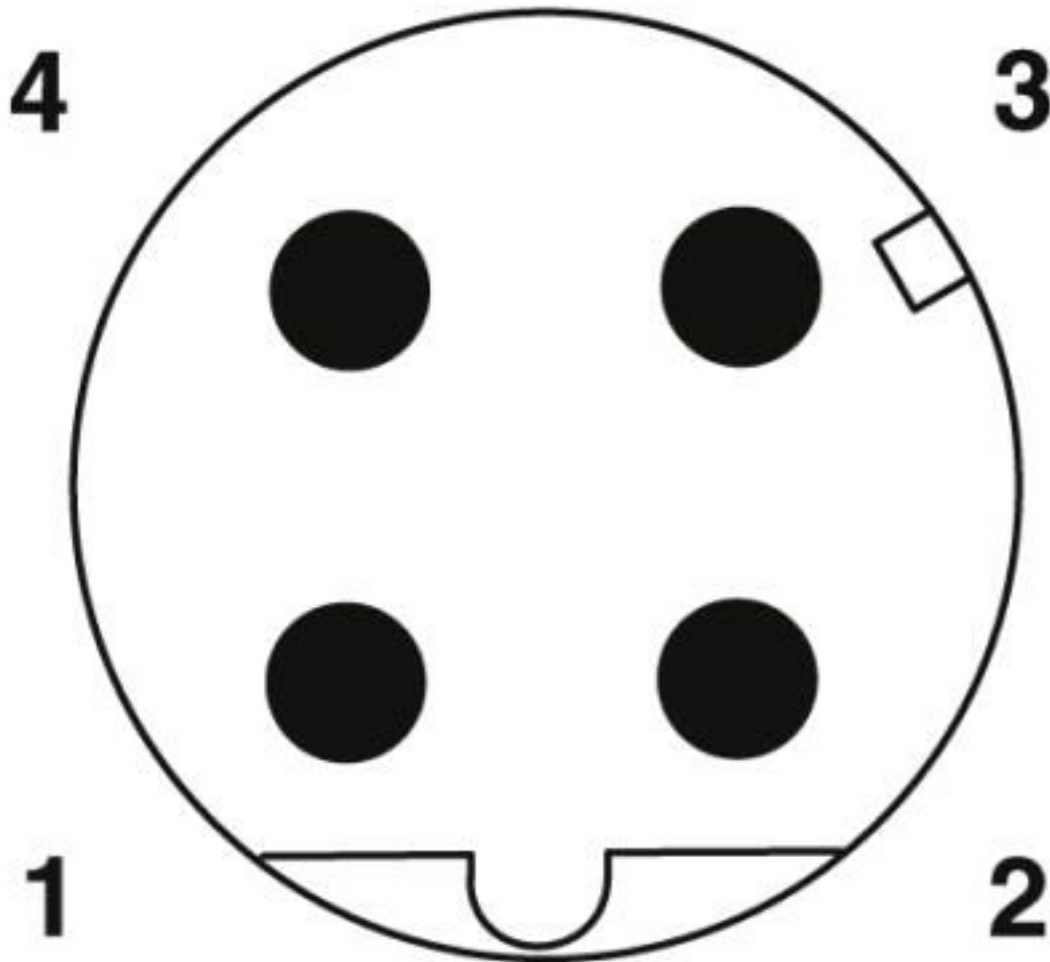

Pin assignment M12 male connector, 4-pos., D-coded, male side

Network cable - VS-M12FSBP-M12MS-936-LI/1,55 - 1403383

Cable cross section



PROFINET RADOX® railway application CAT5 reinforced [936]

Classifications

eCl@ss

eCl@ss 10.0.1	27440102
eCl@ss 4.0	27060300
eCl@ss 4.1	27060300
eCl@ss 5.0	27061800
eCl@ss 5.1	27061800
eCl@ss 6.0	27279200
eCl@ss 7.0	27440103
eCl@ss 8.0	27440103
eCl@ss 9.0	27440102

Network cable - VS-M12FSBP-M12MS-936-LI/1,55 - 1403383

Classifications

ETIM

ETIM 4.0	EC000830
ETIM 5.0	EC002061
ETIM 6.0	EC002061

UNSPSC

UNSPSC 6.01	26121616
UNSPSC 7.0901	26121616
UNSPSC 11	26121604
UNSPSC 12.01	31261501
UNSPSC 13.2	39121413
UNSPSC 18.0	39121413
UNSPSC 19.0	39121413
UNSPSC 20.0	39121413
UNSPSC 21.0	39121413

Approvals

Approvals

Approvals

EAC

Ex Approvals

Approval details

EAC		19060508
-----	---	----------

Phoenix Contact 2020 © - all rights reserved
<http://www.phoenixcontact.com>

PHOENIX CONTACT GmbH & Co. KG
Flachsmarktstr. 8
32825 Blomberg
Germany
Tel. +49 5235 300
Fax +49 5235 3 41200
<http://www.phoenixcontact.com>

X-ON Electronics

Largest Supplier of Electrical and Electronic Components

Click to view similar products for [Ethernet Cables / Networking Cables](#) category:

Click to view products by [Phoenix Contact](#) manufacturer:

Other Similar products are found below :

[73-6670-7](#) [73-6680-15](#) [73-7797-25](#) [MCJB2-10P6Q7-120](#) [84909-0204](#) [1200700174](#) [1200860368](#) [E16A06002M030](#) [E200102-009-S1](#)
[AX105346-EW](#) [MT14-187L](#) [17-103530](#) [ERWPAB3002M005](#) [190-038045-01](#) [NK5EPC18RDY](#) [NK5EPC18VLY](#) [NK5EPC18YLY](#)
[NK5EPC1GRY](#) [NK5EPC4Y](#) [NK5EPC6YLY](#) [NK5EPC8BLY](#) [NK5EPC9YLY](#) [1969343-6](#) [C501100010](#) [C501106002](#) [C501106007](#)
[C501106015](#) [C501106025](#) [C601102010](#) [C601104010](#) [C601106007](#) [C601106015](#) [2142758-2](#) [2168427-2](#) [CAT1106007](#) [21949-1](#) [2J1866A](#)
[RJF SFTP 5E 0500](#) [AX100351](#) [MN14CEC/ST](#) [C501100015](#) [C501106004](#) [C501106010](#) [C5F1108007](#) [C601104004](#) [C601106004](#)
[CA21106004](#) [CA21106010](#) [CA21106015](#) [CA21109007](#)