

Network cable - VS-MSD-IP20-93E/3,0 - 1403499

Please be informed that the data shown in this PDF Document is generated from our Online Catalog. Please find the complete data in the user's documentation. Our General Terms of Use for Downloads are valid (<http://phoenixcontact.com/download>)



Network cable, Ethernet CAT5 (100 Mbps), 4-position, PUR, water blue RAL 5021, shielded, Plug straight M12 / IP67, coding: D, on Plug straight RJ45 / IP20, cable length: 3 m



Ethernet

Key Commercial Data

| | |
|--------------|---|
| Packing unit | 1 pc |
| GTIN |  4 046356 656191 |
| GTIN | 4046356656191 |

Technical data

Dimensions

| | |
|-----------------|-----|
| Length of cable | 3 m |
|-----------------|-----|

Ambient conditions

| | |
|----------------------|-----------------------|
| Degree of protection | IP20 (RJ45 connector) |
| | IP67 (M12 connector) |

General data

| | |
|---|-------------------------------------|
| Rated voltage | 48 V AC |
| | 60 V DC |
| Number of positions | 4 |
| Signal type/category | Ethernet CAT5 (IEC 11801), 100 Mbps |
| Overvoltage category | I |
| Degree of pollution | 3 |
| Housing material | TPU/PA |
| Degree of protection | IP67/IP20 |
| Transmission characteristics (category) | CAT5 |

Characteristics head 1

| | |
|-----------|--------------------------|
| Head type | Plug straight M12 / IP67 |
|-----------|--------------------------|

Network cable - VS-MSD-IP20-93E/3,0 - 1403499

Technical data

Characteristics head 1

| | |
|--|--|
| No. of positions (pin connector pattern) | 4 |
| Coding | D (Data) |
| Color | black |
| Material (component) | CuZn (Contact) |
| | Ni/Au (Contact surface) |
| | TPU GF (Contact carriers) |
| | TPU, hardly inflammable, self-extinguishing (Grip) |
| | Zinc die-cast, nickel-plated (Screw connection) |
| Shielded | yes |
| Insertion/withdrawal cycles | ≥ 100 |
| Torque | 0.4 Nm |
| Ambient temperature (operation) | -25 °C ... 90 °C |
| Shielded | yes |
| Outer sheath, material | PUR |
| External sheath, color | water blue RAL 5021 |
| Type type, plug side | Plug straight |
| Type type, socket side | Plug, straight |

Characteristics head 2

| | |
|--|---------------------------|
| Head type | Plug straight RJ45 / IP20 |
| No. of positions (pin connector pattern) | 4 (8) |
| Color | gray |
| | gray / black |
| Material (component) | CuSn (Contact) |
| | Ni/Au (Contact surface) |
| | PC (Contact carriers) |
| | PA (Housing) |
| Shielded | yes |
| Insertion/withdrawal cycles | ≥ 750 |
| Ambient temperature (operation) | -40 °C ... 60 °C |

Standards and Regulations

| | |
|--|----|
| Flammability rating according to UL 94 | V2 |
|--|----|

Cable

| | |
|---------------------------|-------------------------------------|
| Cable type | Ethernet flexible CAT5, 2-pair |
| Cable type (abbreviation) | 93E |
| UL AWM style | 20963 (80°C/30 V) |
| Signal type/category | Ethernet CAT5 (IEC 11801), 100 Mbps |
| Cable structure | 2x2xAWG26/7; SF/UTP |
| Conductor cross section | 2x 2x 0.14 mm ² |
| AWG signal line | 26 |

Network cable - VS-MSD-IP20-93E/3,0 - 1403499

Technical data

Cable

| | |
|--|--|
| Conductor structure signal line | 7x 0.16 mm |
| Core diameter including insulation | 0.98 mm |
| Wire colors | white/orange-orange, white/green-green |
| Twisted pairs | 2 cores to the pair |
| Overall twist | Two pairs with two fillers to the core |
| Shielding | Aluminum-coated foil, tinned copper braided shield |
| Optical shield covering | 70 % |
| External sheath, color | water blue RAL 5021 |
| Outer sheath thickness | 1.2 mm |
| External cable diameter D | 6.4 mm ±0.2 mm |
| Minimum bending radius, fixed installation | 4 x D |
| Minimum bending radius, flexible installation | 8 x D |
| Tensile strength GRP | ≤ 80 N |
| Cable weight | 42 kg/km |
| Outer sheath, material | PUR |
| Material conductor insulation | Foamed PE |
| Conductor material | Bare Cu litz wires |
| Standards/specifications | Electrical requirements EN 50288-2-2 |
| Insulation resistance | ≥ 500 MΩ*km |
| Loop resistance | ≤ 290.00 Ω/km |
| Cable capacity | approx. 45 nF/km (at 1 kHz) |
| Wave impedance | 100 Ω ±5 Ω (at 100 MHz) |
| Near end crosstalk attenuation (NEXT) | 65.3 dB (with 1 MHz) |
| | 56.3 dB (at 4 MHz) |
| | 50.3 dB (at 10 MHz) |
| | 47.2 dB (at 16 MHz) |
| | 45.8 dB (at 20 MHz) |
| | 42.9 dB (at 31.25 MHz) |
| | 38.4 dB (at 62.5 MHz) |
| | 35.3 dB (at 100 MHz) |
| Power-summed near end crosstalk attenuation (PSNEXT) | 62.3 dB (with 1 MHz) |
| | 53.3 dB (at 4 MHz) |
| | 47.3 dB (at 10 MHz) |
| | 44.2 dB (at 16 MHz) |
| | 42.8 dB (at 20 MHz) |
| | 39.9 dB (at 31.25 MHz) |
| | 35.4 dB (at 62.5 MHz) |
| | 32.3 dB (at 100 MHz) |
| Attenuation | 3.2 dB (with 1 MHz) |
| | 6 dB (at 4 MHz) |

Network cable - VS-MSD-IP20-93E/3,0 - 1403499

Technical data

Cable

| | |
|---|---|
| | 9.5 dB (at 10 MHz) |
| | 12.1 dB (at 16 MHz) |
| | 13.6 dB (at 20 MHz) |
| | 17.1 dB (at 31.25 MHz) |
| | 24.8 dB (at 62.5 MHz) |
| | 32 dB (at 100 MHz) |
| Return loss (RL) | 23 dB (at 4 MHz) |
| | 24.1 dB (at 8 MHz) |
| | 25 dB (at 10 MHz) |
| | 25 dB (at 16 MHz) |
| | 25 dB (at 20 MHz) |
| | 23.6 dB (at 31.25 MHz) |
| | 21.5 dB (at 62.5 MHz) |
| | 20.1 dB (at 100 MHz) |
| Signal runtime | 5.3 ns/m |
| Coupling resistance | ≤ 100.00 mΩ/m (at 10 MHz) |
| Nominal voltage, cable | ≤ 100 V (Peak value, not for high-power applications) |
| Test voltage Core/Core | 700 V (50 Hz, 1 min.) |
| Test voltage Core/Shield | 700 V (50 Hz, 1 min.) |
| Current carrying capacity of cable | 2 A (according to DIN VDE 0891-1) |
| Flame resistance | according to IEC 60332-1-2 |
| | in acc. to UL VW1 |
| Halogen-free | according to IEC 60754-1 |
| Resistance to oil | according to EN 60811-2-1 |
| Ambient temperature (operation) | -40 °C ... 80 °C (cable, fixed installation) |
| | -20 °C ... 80 °C (cable, flexible installation) |
| Ambient temperature (installation) | -20 °C ... 80 °C |
| Ambient temperature (storage/transport) | -20 °C ... 80 °C |

Environmental Product Compliance

| | |
|------------|---|
| REACH SVHC | Lead 7439-92-1 |
| China RoHS | Environmentally Friendly Use Period = 50 years |
| | For details about hazardous substances go to tab "Downloads", Category "Manufacturer's declaration" |

Drawings

Network cable - VS-MSD-IP20-93E/3,0 - 1403499

Schematic diagram

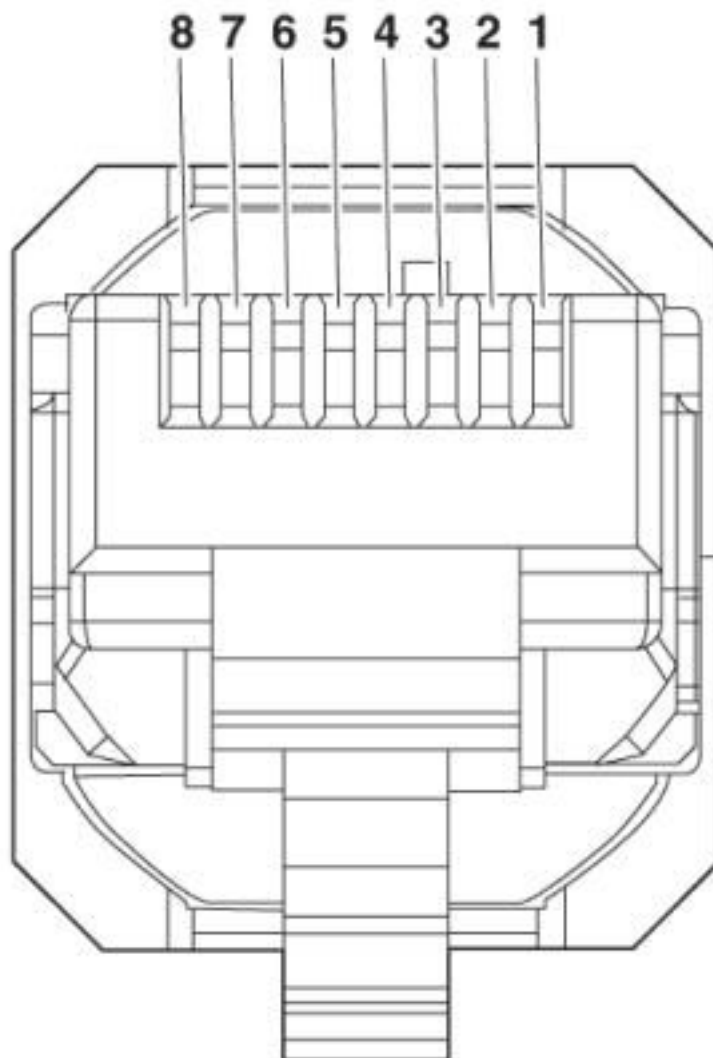

Connector pin assignment plug RJ45

Network cable - VS-MSD-IP20-93E/3,0 - 1403499

Dimensional drawing

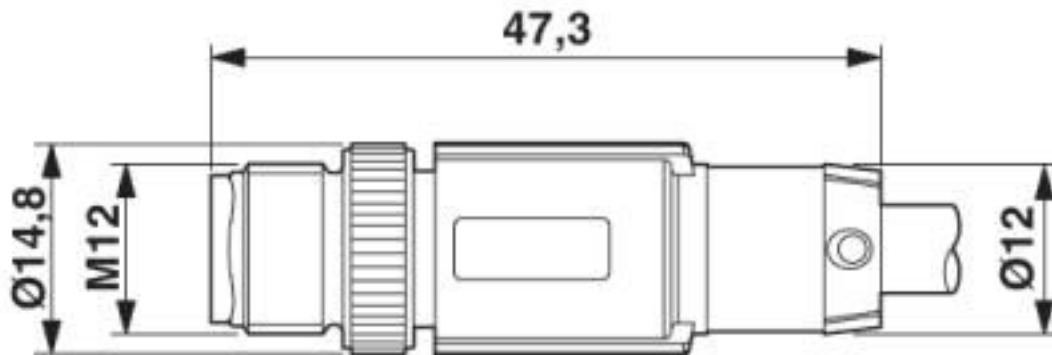

Plug, M12 x 1, straight, shielded

Dimensional drawing

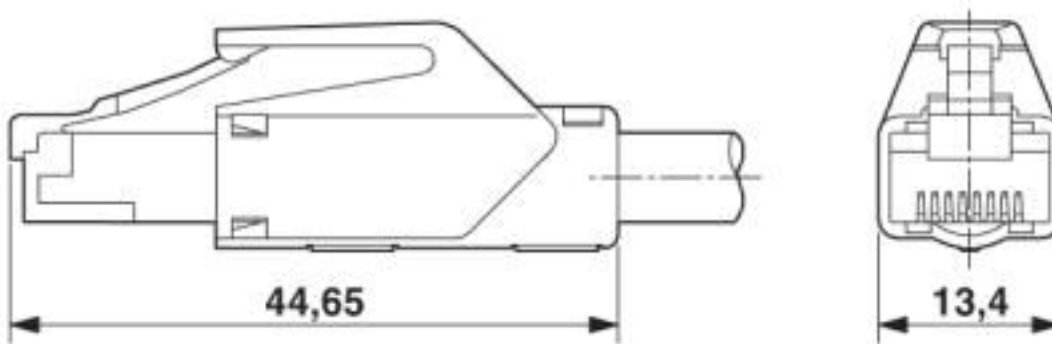

RJ45 connector, IP20

Circuit diagram

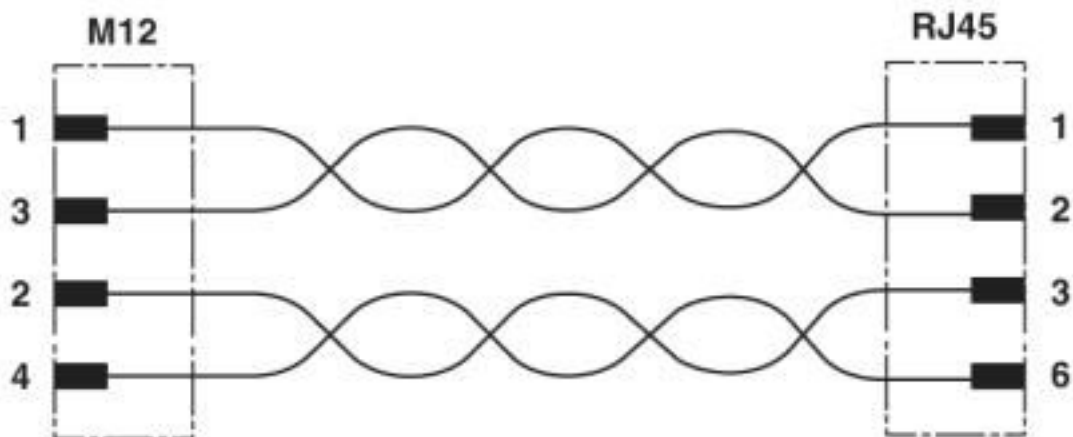

Network cable - VS-MSD-IP20-93E/3,0 - 1403499

Schematic diagram

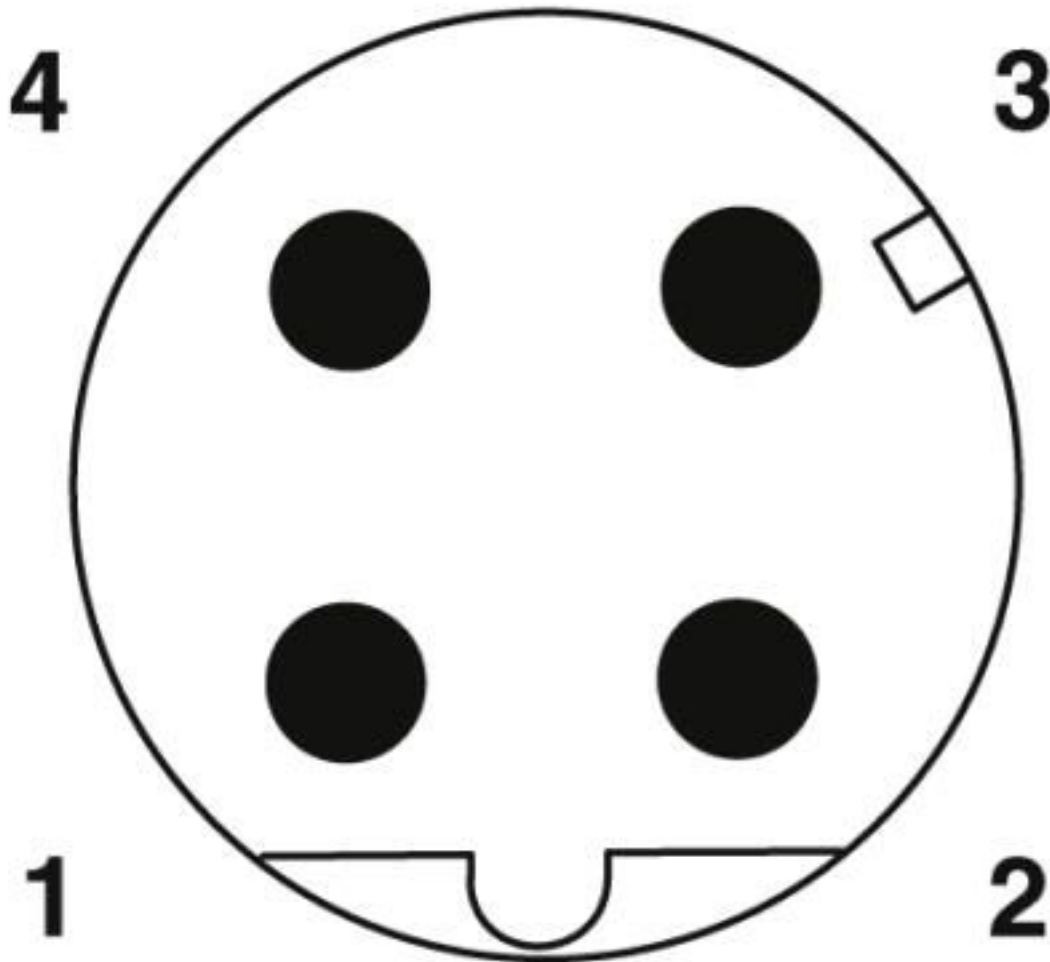

Pin assignment M12 male connector, 4-pos., D-coded, male side

Network cable - VS-MSD-IP20-93E/3,0 - 1403499

Cable cross section

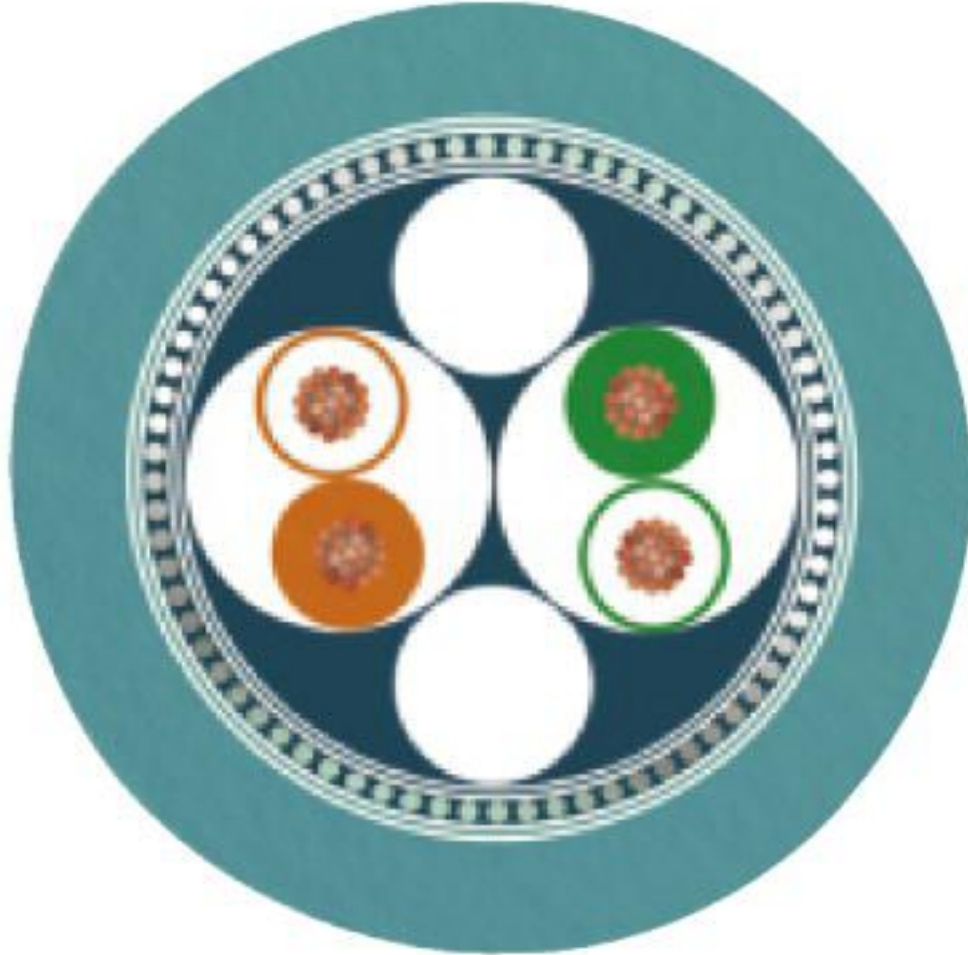

Ethernet flexible CAT5, 2-pair [93E]

Classifications

eCl@ss

| | |
|---------------|----------|
| eCl@ss 10.0.1 | 27060308 |
| eCl@ss 4.0 | 24010400 |
| eCl@ss 4.1 | 24010400 |
| eCl@ss 5.0 | 19030300 |
| eCl@ss 5.1 | 19030300 |
| eCl@ss 6.0 | 27061800 |
| eCl@ss 7.0 | 27061801 |
| eCl@ss 8.0 | 27061801 |
| eCl@ss 9.0 | 27060308 |

Network cable - VS-MSD-IP20-93E/3,0 - 1403499

Classifications

ETIM

| | |
|----------|----------|
| ETIM 4.0 | EC000830 |
| ETIM 5.0 | EC002599 |
| ETIM 6.0 | EC001262 |
| ETIM 7.0 | EC001262 |

UNSPSC

| | |
|---------------|----------|
| UNSPSC 6.01 | 26121609 |
| UNSPSC 7.0901 | 26121609 |
| UNSPSC 11 | 26121609 |
| UNSPSC 12.01 | 26121609 |
| UNSPSC 13.2 | 26121604 |
| UNSPSC 18.0 | 26121604 |
| UNSPSC 19.0 | 26121604 |
| UNSPSC 20.0 | 26121604 |
| UNSPSC 21.0 | 26121604 |

Approvals

Approvals

Approvals

EAC-RoHS

Ex Approvals

Approval details

| | | |
|----------|---|--------------------------|
| EAC-RoHS |  | RU D- DE.HB35.B.00385 |
|----------|---|--------------------------|

Phoenix Contact 2020 © - all rights reserved
<http://www.phoenixcontact.com>

PHOENIX CONTACT GmbH & Co. KG
Flachsmarktstr. 8
32825 Blomberg
Germany
Tel. +49 5235 300
Fax +49 5235 3 41200
<http://www.phoenixcontact.com>

X-ON Electronics

Largest Supplier of Electrical and Electronic Components

Click to view similar products for [Ethernet Cables / Networking Cables](#) category:

Click to view products by [Phoenix Contact](#) manufacturer:

Other Similar products are found below :

[73-6670-7](#) [73-6680-15](#) [73-7797-25](#) [MCJB2-10P6Q7-120](#) [84909-0204](#) [1200700174](#) [1200860368](#) [E16A06002M030](#) [E200102-009-S1](#)
[AX105346-EW](#) [MT14-187L](#) [17-103530](#) [ERWPAB3002M005](#) [190-038045-01](#) [NK5EPC18RDY](#) [NK5EPC18VLY](#) [NK5EPC18YLY](#)
[NK5EPC1GRY](#) [NK5EPC4Y](#) [NK5EPC6YLY](#) [NK5EPC8BLY](#) [NK5EPC9YLY](#) [1969343-6](#) [C501100010](#) [C501106002](#) [C501106007](#)
[C501106015](#) [C501106025](#) [C601102010](#) [C601104010](#) [C601106007](#) [C601106015](#) [2142758-2](#) [2168427-2](#) [CAT1106007](#) [21949-1](#) [2J1866A](#)
[RJF SFTP 5E 0500](#) [AX100351](#) [MN14CEC/ST](#) [C501100015](#) [C501106004](#) [C501106010](#) [C5F1108007](#) [C601104004](#) [C601106004](#)
[CA21106004](#) [CA21106010](#) [CA21106015](#) [CA21109007](#)