

Bus system cable - SAC-2P-MRB/0,5-910/FRB SCO - 1403633

Please be informed that the data shown in this PDF Document is generated from our Online Catalog. Please find the complete data in the user's documentation. Our General Terms of Use for Downloads are valid (<http://phoenixcontact.com/download>)



Bus system cable, PROFIBUS (12 Mbps), 2-position, PUR halogen-free, violet RAL 4001, shielded, Plug angled M12 SPEEDCON, coding: B, on Socket angled M12 SPEEDCON, coding: B, cable length: 0.5 m



Key Commercial Data

Packing unit	1 pc
GTIN	 4 046356 663540
GTIN	4046356663540

Technical data

Dimensions

Length of cable	0.5 m
-----------------	-------

Ambient conditions

Ambient temperature (operation)	-25 °C ... 90 °C (Plug / socket)
Degree of protection	IP65
	IP67

General

Rated current at 40°C	4 A
Rated voltage	48 V AC
	60 V DC
Number of positions	2
Color handle area	black
Insulation resistance	≥ 100 MΩ
Coding	B - inverse
Signal type/category	PROFIBUS, 12 Mbps
Status display	No
Overvoltage category	II
Degree of pollution	3

Bus system cable - SAC-2P-MRB/0,5-910/FRB SCO - 1403633

Technical data

Material

Flammability rating according to UL 94	V0
Contact material	CuSn
Contact surface material	Ni/Au
Contact carrier material	PA 6.6
Material of grip body	TPU, hardly inflammable, self-extinguishing
Material, knurls	Zinc die-cast, nickel-plated
Sealing material	NBR

Standards and Regulations

Flammability rating according to UL 94	V0
--	----

Cable

Cable type	PROFIBUS
Cable type (abbreviation)	910
UL AWM style	21198 (80°C/300 V)
Cable structure	1x2xAWG24/19
Conductor cross section	2x 0.25 mm ² (Signal line)
AWG signal line	24
Conductor structure signal line	19x 0.13 mm
Core diameter including insulation	2.55 mm ±0.07 mm
Wire colors	Red, green
Overall twist	2 cores with 2 fillers to the core
Shielding	Plastic-coated aluminum foil, tinned copper braided shield
Optical shield covering	85 %
External sheath, color	violet RAL 4001
External cable diameter D	7.8 mm ±0.2 mm
Smallest bending radius, fixed installation	40 mm
Smallest bending radius, movable installation	65 mm
Number of bending cycles	4000000
Bending radius	65 mm
Traversing path	4.5 m
Traversing rate	3 m/s
Acceleration	3 m/s ²
Number of bending cycles	5000000
Bending radius	80 mm
Traversing path	4.5 m
Traversing rate	3 m/s
Acceleration	3 m/s ²
Cable weight	90 kg/km
Outer sheath, material	PUR
Material, filler	PP
Material conductor insulation	Foam-Skin PP

Bus system cable - SAC-2P-MRB/0,5-910/FRB SCO - 1403633

Technical data

Cable

Conductor material	Tin-plated Cu litz wires
Insulation resistance	≥ 5 GΩ*km
Conductor resistance	≤ 78.6 Ω/km
Cable capacity	nom. 30 pF/m
Wave impedance	150 Ω ±10 % (3 MHz ... 20 MHz)
Attenuation	≤ 0.049 dB/m (at 16 MHz)
Nominal voltage, cable	30 V
Test voltage Core/Core	1500 V (50 Hz, 1 min.)
Test voltage Core/Shield	1500 V (50 Hz, 1 min.)
Flame resistance	UL 1581, Sec. 1060 (FT-1)
	IEC 60332-1-2
Halogen-free	in accordance with DIN VDE 0472 part 815
	according to IEC 60754-1
Other resistance	Low adhesion
Ambient temperature (operation)	-40 °C ... 80 °C (cable, fixed installation)
	-30 °C ... 80 °C (cable, flexible installation)
	≤ 70 °C (cable, drag chain applications)

Environmental Product Compliance

REACH SVHC	Lead 7439-92-1
China RoHS	Environmentally Friendly Use Period = 50 years
	For details about hazardous substances go to tab "Downloads", Category "Manufacturer's declaration"

Drawings

Bus system cable - SAC-2P-MRB/0,5-910/FRB SCO - 1403633

Dimensional drawing

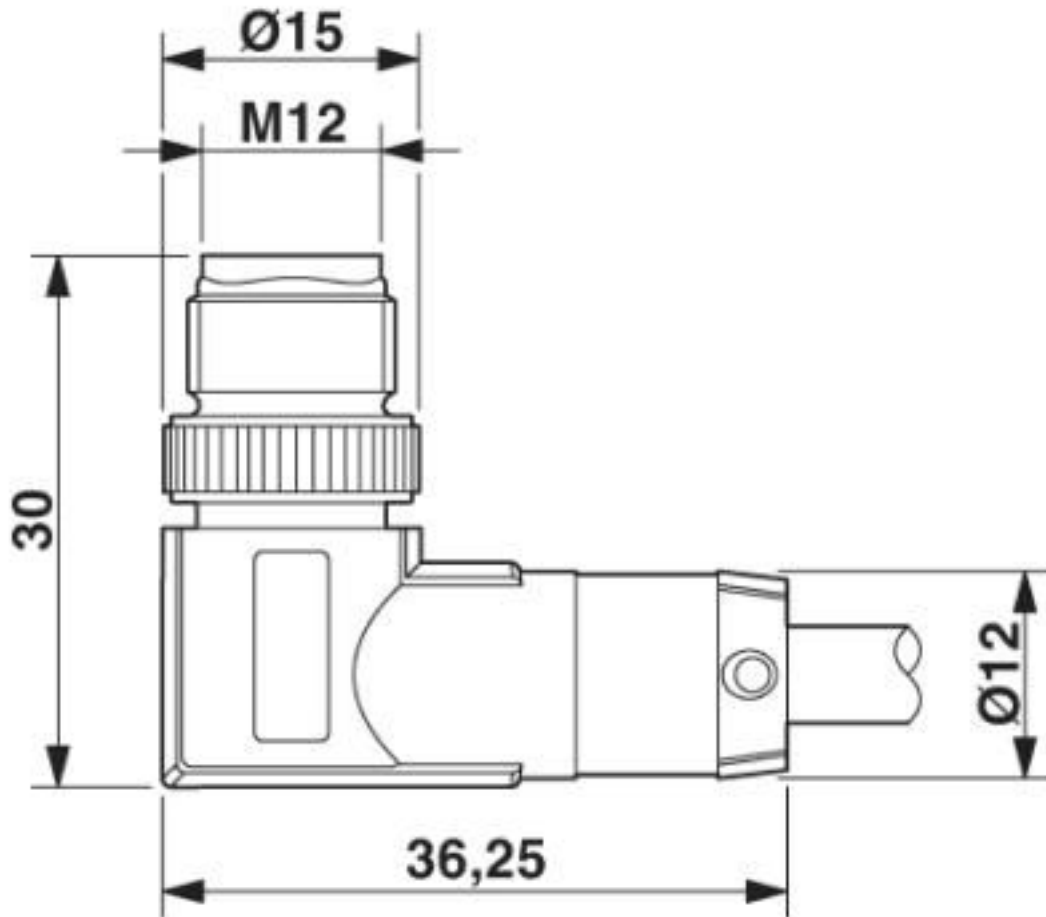

Plug M12 SPEEDCON, angled, shielded

Bus system cable - SAC-2P-MRB/0,5-910/FRB SCO - 1403633

Dimensional drawing

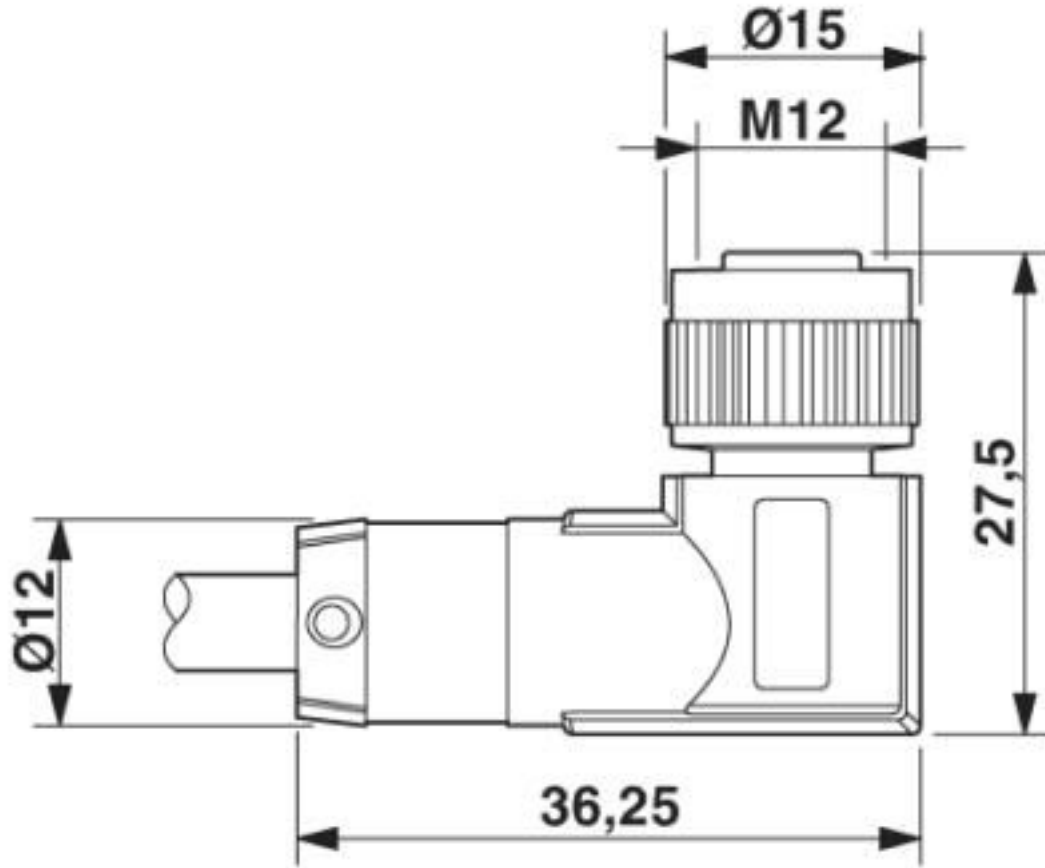

Socket M12-SPEEDCON, angled, shielded

Circuit diagram

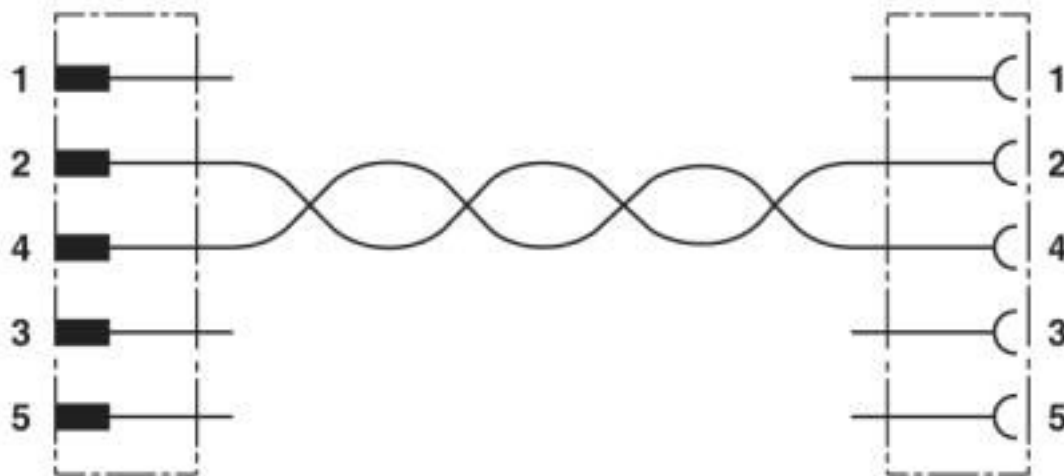

Contact assignment of the M12 plug and the M12 socket

Bus system cable - SAC-2P-MRB/0,5-910/FRB SCO - 1403633

Schematic diagram

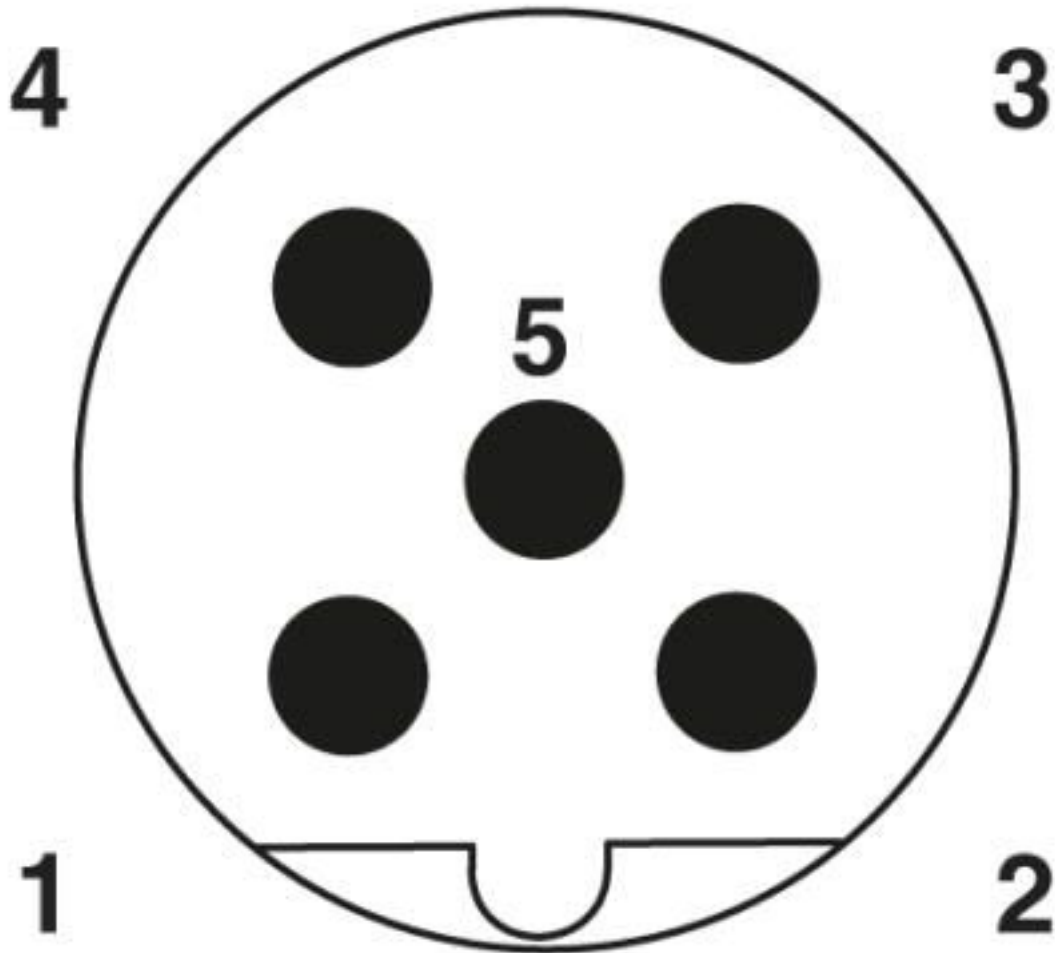

Pin assignment M12 male connector, 5-pos., B-coded, male side

Bus system cable - SAC-2P-MRB/0,5-910/FRB SCO - 1403633

Schematic diagram

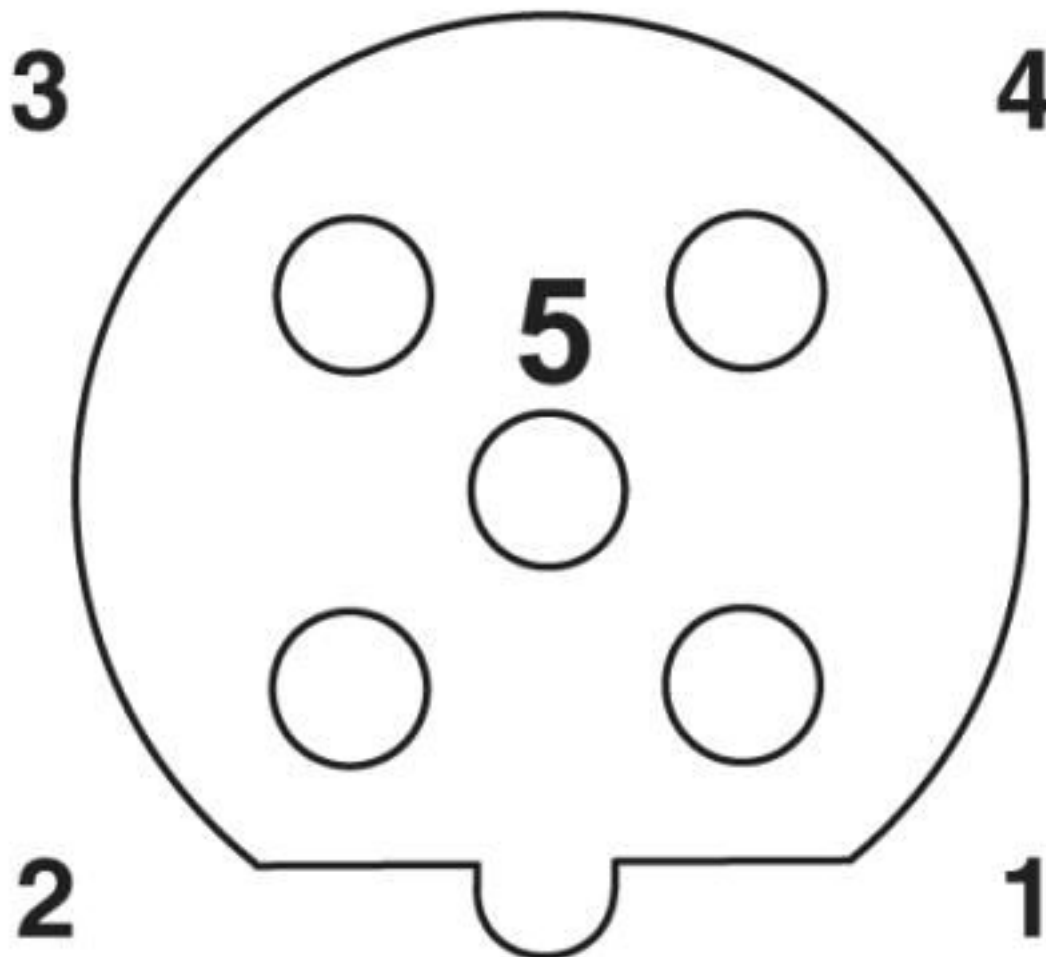

Pin assignment M12 socket, 5-pos., B-coded, female side

Bus system cable - SAC-2P-MRB/0,5-910/FRB SCO - 1403633

Cable cross section

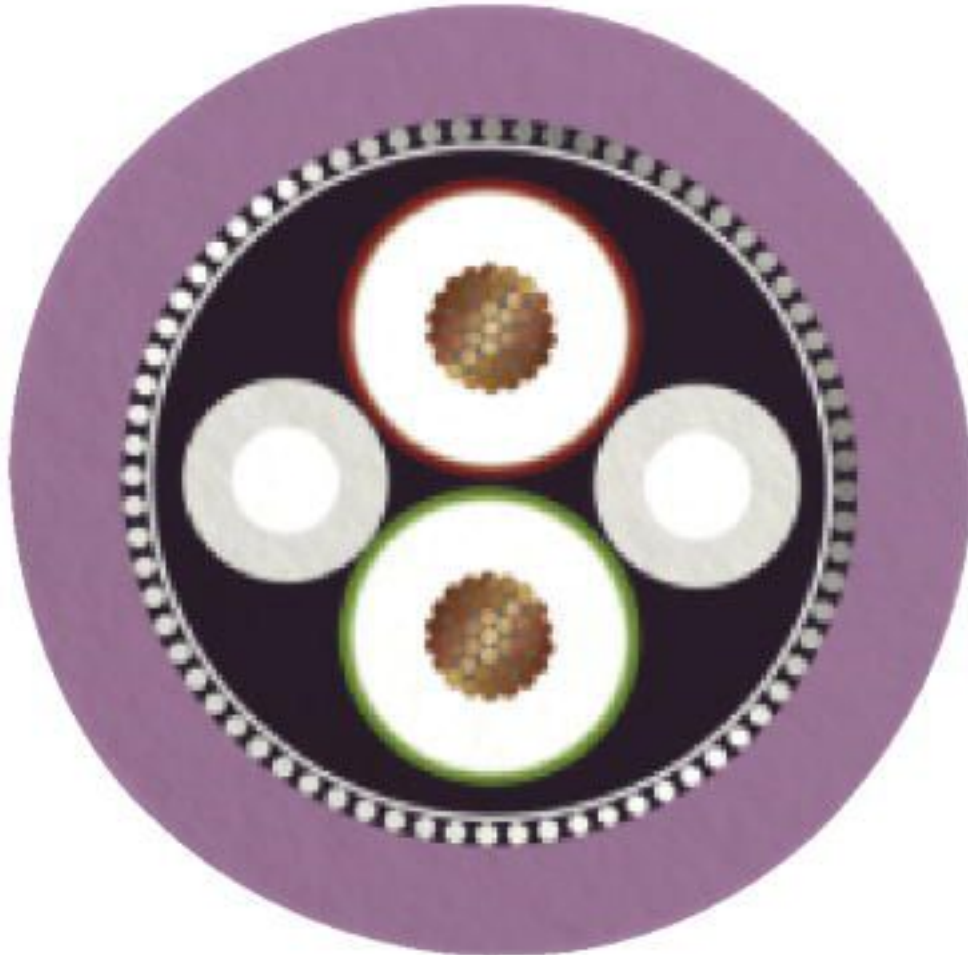

PROFIBUS [910]

Classifications

eCl@ss

eCl@ss 10.0.1	27060308
eCl@ss 4.0	27060300
eCl@ss 4.1	27060300
eCl@ss 5.0	27061800
eCl@ss 5.1	27061800
eCl@ss 6.0	27279200
eCl@ss 7.0	27279218
eCl@ss 8.0	27279218
eCl@ss 9.0	27060308

Bus system cable - SAC-2P-MRB/0,5-910/FRB SCO - 1403633

Classifications

ETIM

ETIM 3.0	EC001855
ETIM 4.0	EC001855
ETIM 5.0	EC002599
ETIM 6.0	EC001262
ETIM 7.0	EC001262

UNSPSC

UNSPSC 6.01	31251501
UNSPSC 7.0901	31251501
UNSPSC 11	31251501
UNSPSC 12.01	31251501
UNSPSC 13.2	31251501
UNSPSC 18.0	26121604
UNSPSC 19.0	26121604
UNSPSC 20.0	26121604
UNSPSC 21.0	26121604

Approvals

Approvals

Approvals

EAC-RoHS

Ex Approvals

Approval details

EAC-RoHS		RU D- DE.HB35.B.00387
----------	--	--------------------------

X-ON Electronics

Largest Supplier of Electrical and Electronic Components

Click to view similar products for [Sensor Cables / Actuator Cables](#) category:

Click to view products by [Phoenix Contact](#) manufacturer:

Other Similar products are found below :

[60963](#) [60964](#) [703000D02F2002](#) [703001D02F0602](#) [703001D02F300](#) [704000D02F120](#) [773032K02F030](#) [802027107404-1](#) [802027213811-1](#)
[804001A09M150](#) [805001A09M0502](#) [84914-0235](#) [84914-0237](#) [885030A09M020](#) [8R4J30E03C3003](#) [1200651332](#) [1200651713](#) [1200660844](#)
[1200660845](#) [1200661173](#) [1200680071](#) [1200720053](#) [1200720081](#) [1200720099](#) [1200720217](#) [1200800231](#) [1200860125](#) [1200870123](#)
[1200980102](#) [1200650267](#) [1200650298](#) [1200660183](#) [1200660782](#) [1200660849](#) [1200661295](#) [1200661297](#) [1200661342](#) [1200661343](#)
[1200670080](#) [1200670220](#) [1200680331](#) [1200720252](#) [1200730184](#) [1200860344](#) [1200870359](#) [1200870643](#) [1200980008](#) [1200980031](#)
[1210502211](#) [1210400542](#)