

Sensor/actuator cable - SAC-4P-M12MR/5,0-600 FB - 1404008

Please be informed that the data shown in this PDF Document is generated from our Online Catalog. Please find the complete data in the user's documentation. Our General Terms of Use for Downloads are valid (<http://phoenixcontact.com/download>)



Sensor/actuator cable, 4-position, PP-EPDM halogen-free, gray RAL 7035, Plug angled M12, coding: A, on free cable end, cable length: 5 m, Hygienic design, with plastic knurl

Your advantages

- ✓ Easy and safe: 100% electrically tested plug-in components
- ✓ Easy to clean, thanks to the special hygienic design
- ✓ Contamination can be detected quickly – thanks to the light color

Key Commercial Data

Packing unit	1 pc
GTIN	
GTIN	4046356677547

Technical data

Dimensions

Length of cable	5 m
-----------------	-----

Ambient conditions

Ambient temperature (operation)	-40 °C ... 105 °C (Plug / socket)
Degree of protection	IP65
	IP67
	IP68
	IP69K

General

Rated current at 40°C	4 A
Rated voltage	250 V AC
	250 V DC
Number of positions	4

Sensor/actuator cable - SAC-4P-M12MR/5,0-600 FB - 1404008

Technical data

General

Insulation resistance	≥ 100 MΩ
Coding	A - standard
Standards/regulations	M12 connector IEC 61076-2-101
	Material conformance FDA 21 CFR 177.2600
Status display	No
Protective circuit/component	unwired
Overvoltage category	II
Degree of pollution	3
Insertion/withdrawal cycles	≥ 100
Torque	0.4 Nm (M12 connector)

Material

Contact material	CuSn
Contact surface material	Ni/Au
Contact carrier material	PP
Material of grip body	PP
Material, knurls	Polypropylene

Standards and Regulations

Standards/specifications	M12 connector IEC 61076-2-101
	Material conformance FDA 21 CFR 177.2600

Cable

Cable type	Halogen-free PP gray
Cable type (abbreviation)	600
Cable abbreviation	Li9Y9Y
Conductor cross section	4x 0.34 mm ² (Signal line)
AWG signal line	22
Conductor structure signal line	42x 0.10 mm
Core diameter including insulation	1.27 mm ±0.02 mm (Signal line)
Thickness, insulation	≥ 0.21 mm (Core insulation)
Wire colors	brown, white, blue, black
Overall twist	4 wires, twisted
Length of twist, overall twist	48 mm
External sheath, color	gray RAL 7035
Outer sheath thickness	approx. 0.8 mm
External cable diameter D	4.7 mm ±0.15 mm
Minimum bending radius, fixed installation	5 x D
Minimum bending radius, flexible installation	10 x D
Number of bending cycles	4000000
Minimum bending radius, drag chain applications	10 x D
Traversing path	10 m

Sensor/actuator cable - SAC-4P-M12MR/5,0-600 FB - 1404008

Technical data

Cable

Traversing rate	3 m/s
Acceleration	10 m/s ²
Torsion force	± 270 °/m (4,000,000 torsion cycles, max. 25 torsion cycles/min)
Cable weight	30 kg/km
Outer sheath, material	PP-EPDM
Material conductor insulation	PP
Conductor material	Bare Cu litz wires
Conductor resistance	58 Ω/km (at 20 °C)
Nominal voltage, cable	≤ 300 V AC
Test voltage, cable	≥ 3000 V AC (Spark test)
Special properties	FDA compliant according to FDA 21 CFR 177.2600
	highly flexible
	Flexible cable conduit capable
Halogen-free	in accordance with DIN VDE 0472 part 815
Other resistance	Resistant to cold bending and cold impacts According to DIN EN 60811-1-4 (-40 °C)
Ambient temperature (operation)	-40 °C ... 105 °C (cable, fixed installation)
	-25 °C ... 105 °C (cable, flexible installation)

Environmental Product Compliance

China RoHS	Environmentally friendly use period: unlimited = EFUP-e
	No hazardous substances above threshold values

Drawings

Sensor/actuator cable - SAC-4P-M12MR/5,0-600 FB - 1404008

Dimensional drawing

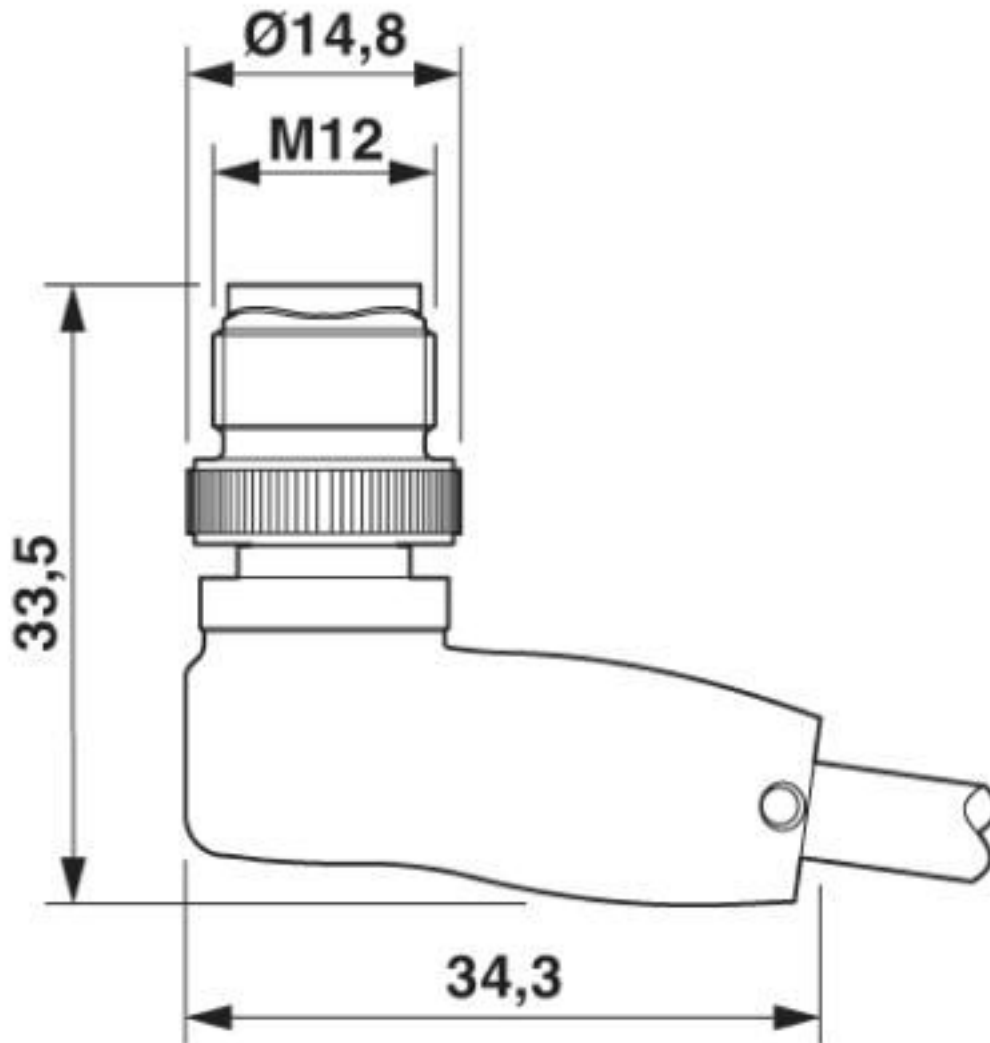

M12 x 1 male plug, angled

Sensor/actuator cable - SAC-4P-M12MR/5,0-600 FB - 1404008

Circuit diagram

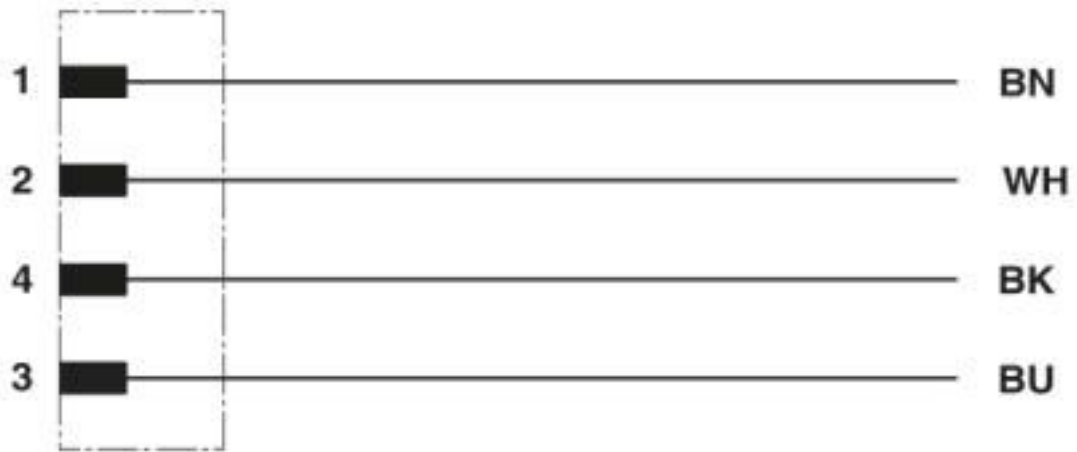

Contact assignment of the M12 plug

Sensor/actuator cable - SAC-4P-M12MR/5,0-600 FB - 1404008

Schematic diagram



Pin assignment M12 plug, 4-pos., A-coded, view plug side

Sensor/actuator cable - SAC-4P-M12MR/5,0-600 FB - 1404008

Cable cross section

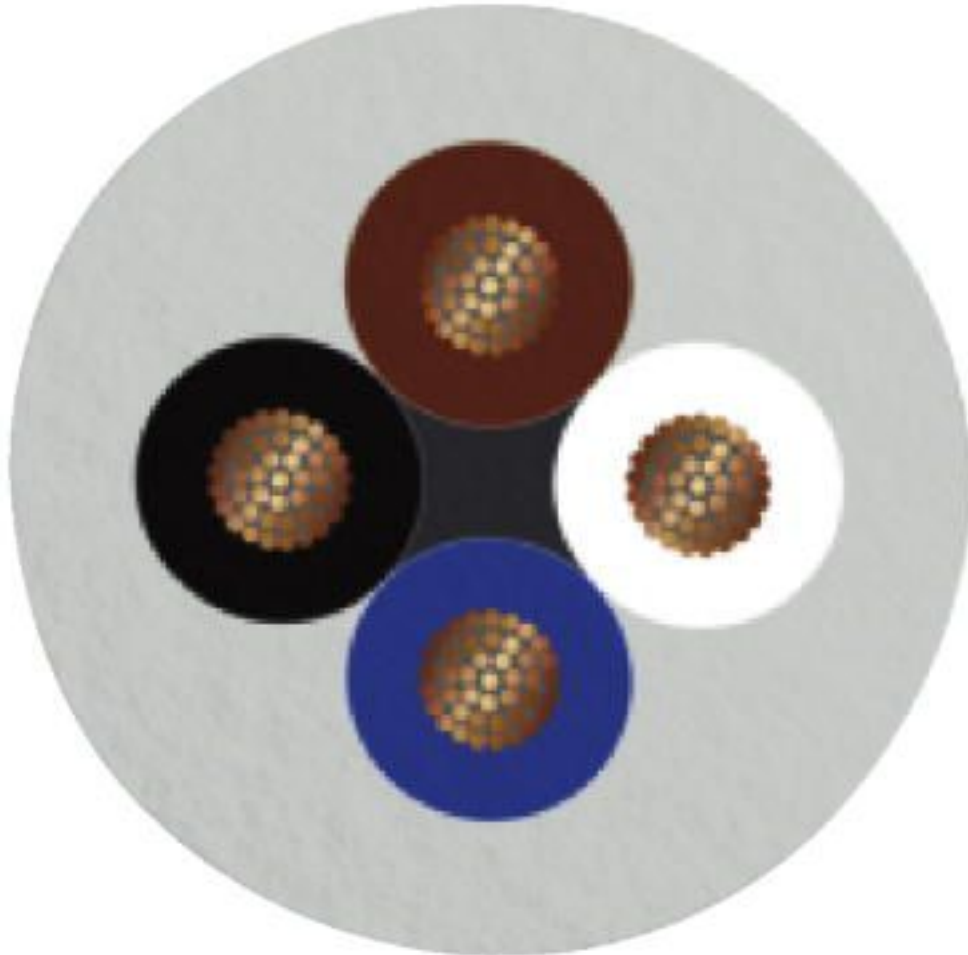

Halogen-free PP gray [600]

Classifications

eCl@ss

eCl@ss 10.0.1	27060311
eCl@ss 4.0	27060300
eCl@ss 4.1	27060300
eCl@ss 5.0	27061800
eCl@ss 5.1	27061800
eCl@ss 6.0	27279200
eCl@ss 7.0	27279218
eCl@ss 8.0	27279218
eCl@ss 9.0	27060311

Sensor/actuator cable - SAC-4P-M12MR/5,0-600 FB - 1404008

Classifications

ETIM

ETIM 3.0	EC001855
ETIM 4.0	EC001855
ETIM 5.0	EC001855
ETIM 6.0	EC001855
ETIM 7.0	EC001855

UNSPSC

UNSPSC 6.01	31251501
UNSPSC 7.0901	31251501
UNSPSC 11	31251501
UNSPSC 12.01	31251501
UNSPSC 13.2	31251501
UNSPSC 19.0	31251501
UNSPSC 20.0	31251501
UNSPSC 21.0	31251501

Approvals

Approvals

Approvals

EAC-RoHS / EAC

Ex Approvals

Approval details

EAC-RoHS		RU D- DE.HB35.B.00387
----------	--	--------------------------

EAC		RU C- DE.BL08.B.00286
-----	--	--------------------------

Accessories

Accessories

Cutting tools

Sensor/actuator cable - SAC-4P-M12MR/5,0-600 FB - 1404008

Accessories

Diagonal cutter - CUTFOX-S VDE - 1212207



Diagonal cutter for hard (piano wire) and soft wires, VDE 1000 V AC/1500 V DC tested

Stripping tool

Stripping tool - WIREFOX SAC - 1212623



Stripping pliers, for halogen-free sensor/actuator cables (SAC cables), with PUR and PVC insulation, from Ø of 4.4 to 7 mm, any stripping length

Stripping tool - WIREFOX 10 - 1212150



Stripping tool, for cables and conductors from 0.02 - 10 mm², self-adjusting, stripping length of up to 18 mm, cutting capacity of up to 10 mm² stranded/1.5 mm² solid, replaceable stripping blade

Phoenix Contact 2020 © - all rights reserved
<http://www.phoenixcontact.com>

PHOENIX CONTACT GmbH & Co. KG
Flachsmarktstr. 8
32825 Blomberg
Germany
Tel. +49 5235 300
Fax +49 5235 3 41200
<http://www.phoenixcontact.com>

X-ON Electronics

Largest Supplier of Electrical and Electronic Components

Click to view similar products for [Sensor Cables / Actuator Cables](#) category:

Click to view products by [Phoenix Contact](#) manufacturer:

Other Similar products are found below :

[60963](#) [60964](#) [703000D02F2002](#) [703001D02F0602](#) [703001D02F300](#) [704000D02F120](#) [773032K02F030](#) [802027107404-1](#) [802027213811-1](#)
[804001A09M150](#) [805001A09M0502](#) [84914-0235](#) [84914-0237](#) [885030A09M020](#) [8R4J30E03C3003](#) [1200651332](#) [1200651713](#) [1200660844](#)
[1200660845](#) [1200661173](#) [1200680071](#) [1200720053](#) [1200720081](#) [1200720099](#) [1200720217](#) [1200800231](#) [1200860125](#) [1200870123](#)
[1200980102](#) [1200650267](#) [1200650298](#) [1200660183](#) [1200660782](#) [1200660849](#) [1200661295](#) [1200661297](#) [1200661342](#) [1200661343](#)
[1200670080](#) [1200670220](#) [1200680331](#) [1200720252](#) [1200730184](#) [1200860344](#) [1200870359](#) [1200870643](#) [1200980008](#) [1200980031](#)
[1210502211](#) [1210400542](#)