

Bus system cable - SAC-2P-M12MSB/ 4,0-915/M12FSB - 1404869

Please be informed that the data shown in this PDF Document is generated from our Online Catalog. Please find the complete data in the user's documentation. Our General Terms of Use for Downloads are valid (<http://phoenixcontact.com/download>)



Bus system cable, PROFIBUS, 2-position, PUR/PVC, blue, shielded, Plug straight M12, coding: B, on Socket straight M12, coding: B, cable length: 4 m



Key Commercial Data

Packing unit	1 pc
Minimum order quantity	25 pc
GTIN	 4 046356 726009
GTIN	4046356726009

Technical data

Dimensions

Length of cable	4 m
-----------------	-----

Ambient conditions

Ambient temperature (operation)	-25 °C ... 90 °C (Plug / socket)
Degree of protection	IP65
	IP67

General

Rated current at 40°C	4 A
Rated voltage	48 V AC
	60 V DC
Number of positions	2
Color handle area	black
Insulation resistance	≥ 100 MΩ
Coding	B - inverse
Signal type/category	PROFIBUS
Status display	No
Overvoltage category	II

Bus system cable - SAC-2P-M12MSB/ 4,0-915/M12FSB - 1404869

Technical data

General

Degree of pollution	3
Insertion/withdrawal cycles	≥ 100
Torque	0.4 Nm (M12 connector)

Material

Flammability rating according to UL 94	V0
Contact material	CuSn
Contact surface material	Ni/Au
Contact carrier material	PA 6.6
Material of grip body	TPU, hardly inflammable, self-extinguishing
Material, knurls	Zinc die-cast, nickel-plated
Sealing material	NBR

Pin assignment

Contact Color (signal designation) Contact (optional)	2 (Plug) GN (A cable) 2 (Socket)
	4 (Plug) RD (B cable) 4 (Socket)

Standards and Regulations

Flammability rating according to UL 94	V0
--	----

Cable

Cable type	PROFIBUS
Cable type (abbreviation)	915
Cable structure	1x2xAWG24/19
Conductor cross section	2x 0.25 mm ²
AWG signal line	24
Conductor structure signal line	19x 0.14 mm
Core diameter including insulation	2.56 mm
Wire colors	Red, green
Overall twist	2 wires, twisted
Shielding	Aluminum-coated foil, tinned copper braided shield
Optical shield covering	70 %
External sheath, color	blue
Outer sheath thickness	approx. 0.8 mm
External cable diameter D	8 mm ±0.4 mm
Minimum bending radius, flexible installation	5 x D
Number of bending cycles	3000000
Bending radius	60 mm
Acceleration	4 m/s ²
Cable weight	74 kg/km
Tensile strength GRP	≤ 100 N
Outer sheath, material	PUR
Material, inner sheath	PVC

Bus system cable - SAC-2P-M12MSB/ 4,0-915/M12FSB - 1404869

Technical data

Cable

Material conductor insulation	Foamed PE
Conductor material	Bare Cu litz wires
Insulation resistance	$\geq 16 \text{ G}\Omega \cdot \text{km}$
Working capacitance	28 nF (at 1 kHz)
Nominal voltage, cable	$\leq 100 \text{ V}$
Test voltage Core/Core	3600 V DC
Flame resistance	according to IEC 60332-1
Resistance to oil	Resistant to mineral oils and grease
Ambient temperature (operation)	-40 °C ... 80 °C (cable, flexible installation)

Environmental Product Compliance

China RoHS	Environmentally friendly use period: unlimited = EFUP-e
	No hazardous substances above threshold values

Drawings

Dimensional drawing

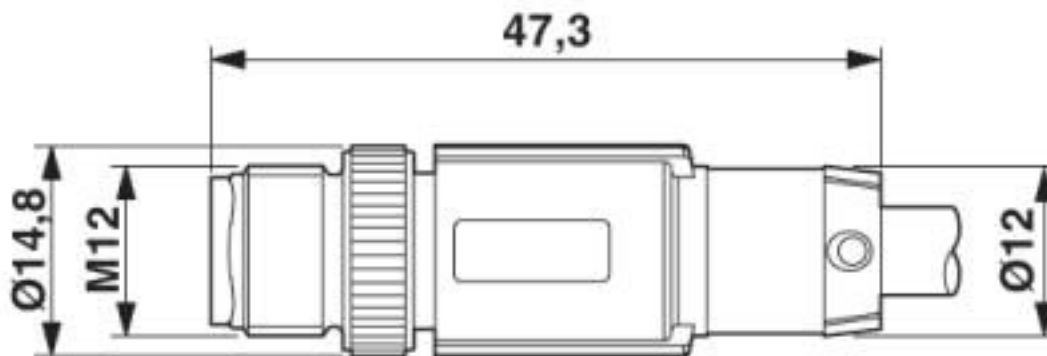

Plug, M12 x 1, straight, shielded

Bus system cable - SAC-2P-M12MSB/ 4,0-915/M12FSB - 1404869

Dimensional drawing

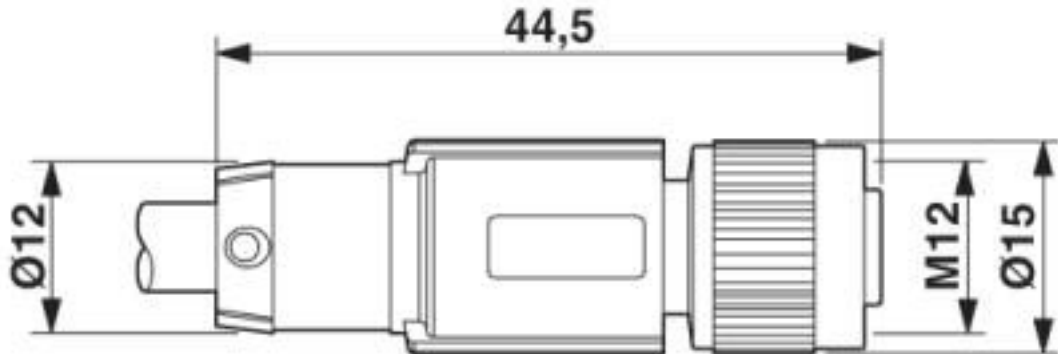

M12 x 1 socket, straight, shielded

Circuit diagram

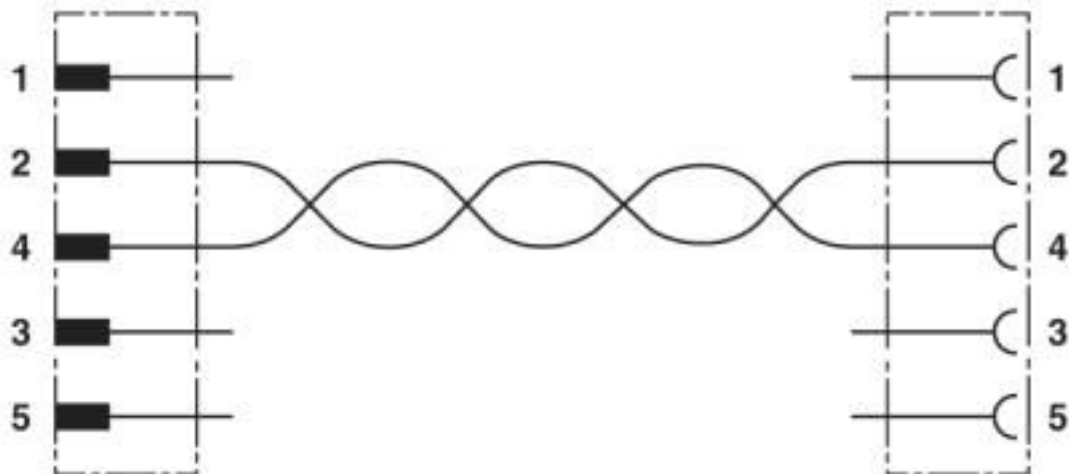

Bus system cable - SAC-2P-M12MSB/ 4,0-915/M12FSB - 1404869

Schematic diagram

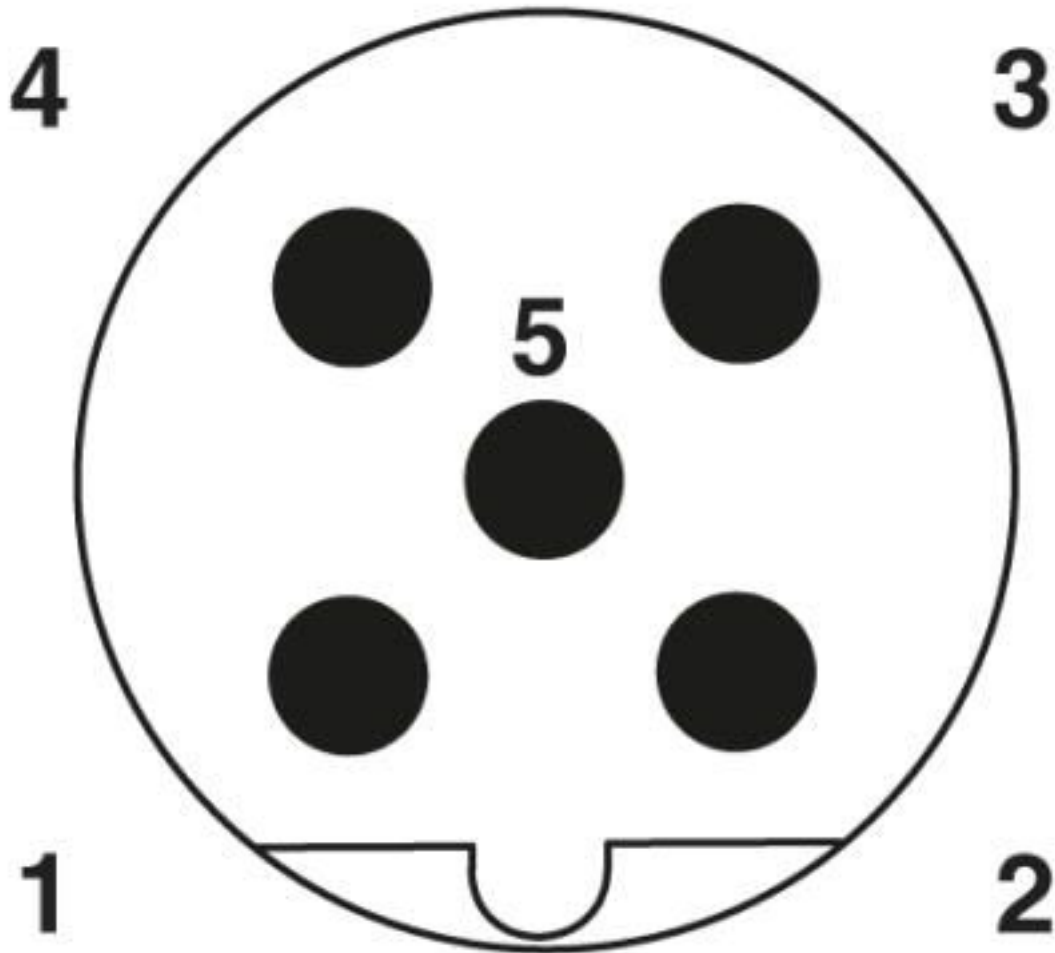

Pin assignment M12 male connector, 5-pos., B-coded, male side

Bus system cable - SAC-2P-M12MSB/ 4,0-915/M12FSB - 1404869

Schematic diagram

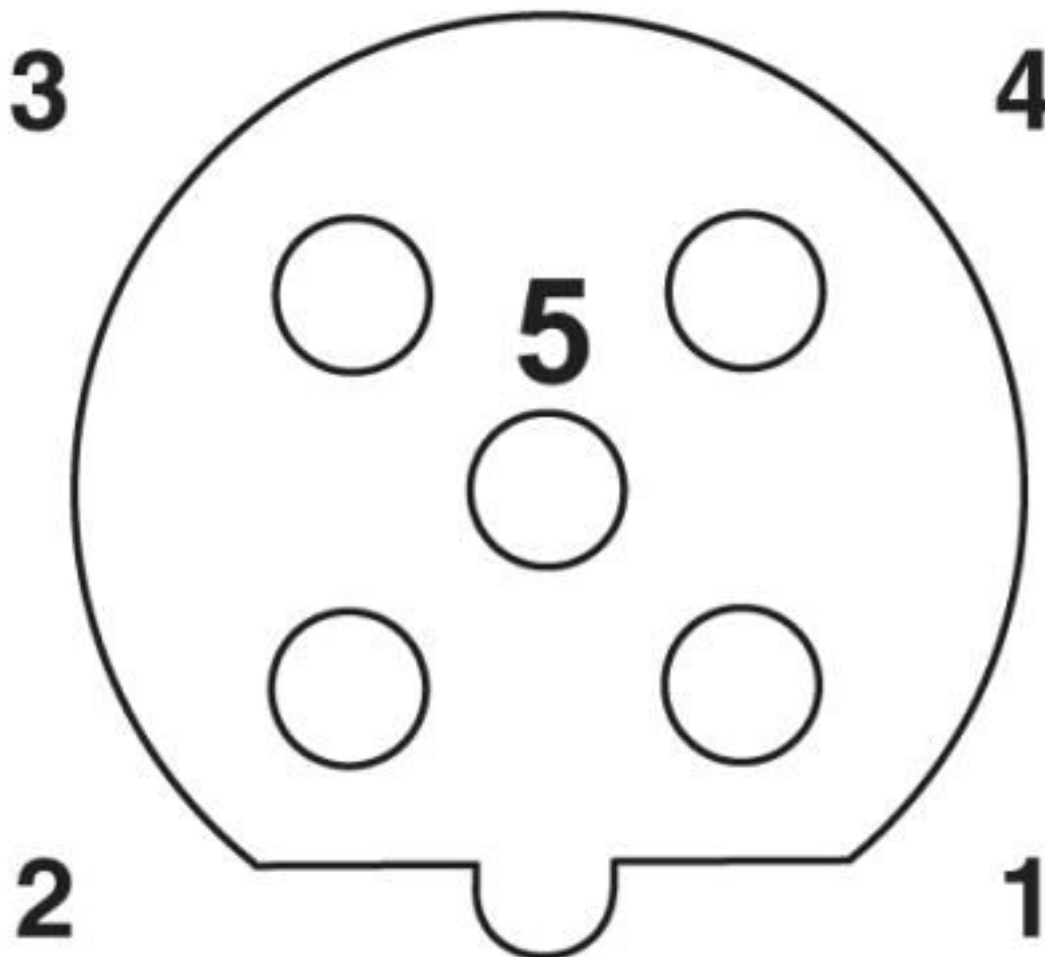

Pin assignment M12 socket, 5-pos., B-coded, female side

Classifications

eCl@ss

eCl@ss 10.0.1	27060311
eCl@ss 4.0	27060300
eCl@ss 4.1	27060300
eCl@ss 5.0	27061800
eCl@ss 5.1	27061800
eCl@ss 6.0	27279200
eCl@ss 7.0	27279218
eCl@ss 8.0	27279218
eCl@ss 9.0	27060311

Bus system cable - SAC-2P-M12MSB/ 4,0-915/M12FSB - 1404869

Classifications

ETIM

ETIM 3.0	EC001855
ETIM 4.0	EC001855
ETIM 5.0	EC001855
ETIM 6.0	EC001855
ETIM 7.0	EC001855

UNSPSC

UNSPSC 6.01	31251501
UNSPSC 7.0901	31251501
UNSPSC 11	31251501
UNSPSC 12.01	31251501
UNSPSC 13.2	31251501
UNSPSC 19.0	31251501
UNSPSC 20.0	31251501
UNSPSC 21.0	31251501

Approvals

Approvals

Approvals

EAC-RoHS / EAC

Ex Approvals

Approval details

EAC-RoHS		RU D- DE.HB35.B.00387
----------	---	--------------------------

EAC		RU C- DE.BL08.B.00286
-----	---	--------------------------

Phoenix Contact 2020 © - all rights reserved
<http://www.phoenixcontact.com>

PHOENIX CONTACT GmbH & Co. KG
Flachmarktstr. 8
32825 Blomberg
Germany
Tel. +49 5235 300
Fax +49 5235 3 41200
<http://www.phoenixcontact.com>

X-ON Electronics

Largest Supplier of Electrical and Electronic Components

Click to view similar products for [Ethernet Cables / Networking Cables](#) category:

Click to view products by [Phoenix Contact](#) manufacturer:

Other Similar products are found below :

[73-6670-7](#) [73-6680-15](#) [73-7797-25](#) [MCJB2-10P6Q7-120](#) [84909-0204](#) [1200700174](#) [1200860368](#) [E16A06002M030](#) [E200102-009-S1](#)
[AX105346-EW](#) [MT14-187L](#) [17-103530](#) [ERWPAB3002M005](#) [190-038045-01](#) [NK5EPC18RDY](#) [NK5EPC18VLY](#) [NK5EPC18YLY](#)
[NK5EPC1GRY](#) [NK5EPC4Y](#) [NK5EPC6YLY](#) [NK5EPC8BLY](#) [NK5EPC9YLY](#) [1969343-6](#) [C501100010](#) [C501106002](#) [C501106007](#)
[C501106015](#) [C501106025](#) [C601102010](#) [C601104010](#) [C601106007](#) [C601106015](#) [2142758-2](#) [2168427-2](#) [CAT1106007](#) [21949-1](#) [2J1866A](#)
[RJF SFTP 5E 0500](#) [AX100351](#) [MN14CEC/ST](#) [C501100015](#) [C501106004](#) [C501106010](#) [C5F1108007](#) [C601104004](#) [C601106004](#)
[CA21106004](#) [CA21106010](#) [CA21106015](#) [CA21109007](#)