

Bus system cable - SAC-5P- 5,0-924/FR SCO - 1405982

Please be informed that the data shown in this PDF Document is generated from our Online Catalog. Please find the complete data in the user's documentation. Our General Terms of Use for Downloads are valid (<http://phoenixcontact.com/download>)



Bus system cable, CANopen®, DeviceNet™, 5-position, PVC, gray, shielded, free cable end, on Socket angled M12 SPEEDCON, coding: A, cable length: 5 m, Connector unshielded



Key Commercial Data

Packing unit	1 pc
Minimum order quantity	50 pc
GTIN	 4 046356 800464
GTIN	4046356800464

Technical data

Dimensions

Length of cable	5 m
-----------------	-----

Ambient conditions

Ambient temperature (operation)	-25 °C ... 90 °C (Plug / socket)
Degree of protection	IP65
	IP67
	IP68

General

Rated current at 40°C	4 A
Rated voltage	48 V AC
	60 V DC
Number of positions	5
Insulation resistance	≥ 100 MΩ
Coding	A - standard
Signal type/category	CANopen®
	DeviceNet™

Bus system cable - SAC-5P- 5,0-924/FR SCO - 1405982

Technical data

General

Status display	No
Overvoltage category	II
Degree of pollution	3
Torque	0.4 Nm (M12 connector)

Material

Flammability rating according to UL 94	HB
Contact material	CuSn
Contact surface material	Ni/Au
Contact carrier material	TPU GF
Material of grip body	TPU, hardly inflammable, self-extinguishing
Material, knurls	Zinc die-cast, nickel-plated
Sealing material	NBR

Standards and Regulations

Flammability rating according to UL 94	HB
--	----

Cable

Cable type	CANopen [®] /DeviceNet [™] , PVC, gray
Cable type (abbreviation)	924
UL AWM style	2464 (80°C/300 V)
Cable structure	2xAWG22 (Signal) + 2xAWG22 (Power)
Conductor cross section	2x 0.34 mm ² (Signal line)
	2x 0.34 mm ² (Power supply)
AWG signal line	22
AWG power supply	22
Conductor structure signal line	19x 0.15 mm
Conductor structure, voltage supply	19x 0.15 mm
Core diameter including insulation	1.27 mm ±0.05 mm (Signal line)
	2.24 mm ±0.13 mm (Power supply)
Wire colors	Red-black, blue-white
Twisted pairs	2 cores to the pair
Type of pair shielding	Plastic-coated aluminum foil, aluminum side inside
Overall twist	2 pairs around a drain wire in the center to the core
Shielding	Plastic-coated aluminum foil with a filler litz wire, aluminum side outside
External sheath, color	gray
External cable diameter D	6.9 mm ±0.13 mm
Minimum bending radius, flexible installation	15 x D
Cable weight	64.51 kg/km
Outer sheath, material	PVC
Material conductor insulation	Foamed PE (Signal line)
	PVC (Power supply)

Bus system cable - SAC-5P- 5,0-924/FR SCO - 1405982

Technical data

Cable

Conductor material	Bare Cu litz wires
Insulation resistance	≥ 59.38 Ω*m (Signal line)
	≥ 57.41 GΩ*km (Power supply)
Working capacitance	nom. 78.74 pF (per meter)
Wave impedance	120 Ω ±12 Ω
Signal runtime	4.46 ns/m
Shield attenuation	0.95 dB (f = 125 kHz)
	1.64 dB (f = 500 kHz)
	2.3 dB (f = 1 MHz)
Special properties	UL standards PLTC and ITC
Resistance to oil	yes
Other resistance	UV resistant
Ambient temperature (operation)	-30 °C ... 75 °C (cable, fixed installation)

Environmental Product Compliance

China RoHS	Environmentally Friendly Use Period = 50 years
	For details about hazardous substances go to tab "Downloads", Category "Manufacturer's declaration"

Drawings

Bus system cable - SAC-5P- 5,0-924/FR SCO - 1405982

Dimensional drawing

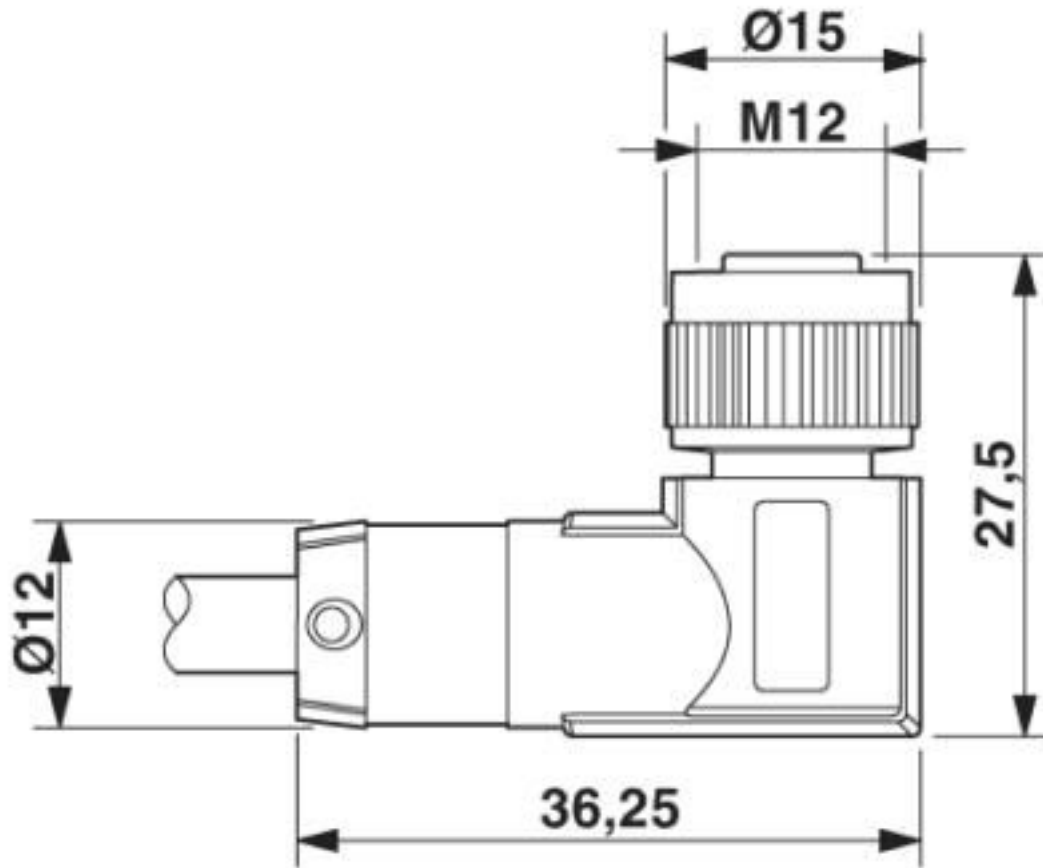

M12 x 1 socket, angled

Bus system cable - SAC-5P- 5,0-924/FR SCO - 1405982

Circuit diagram

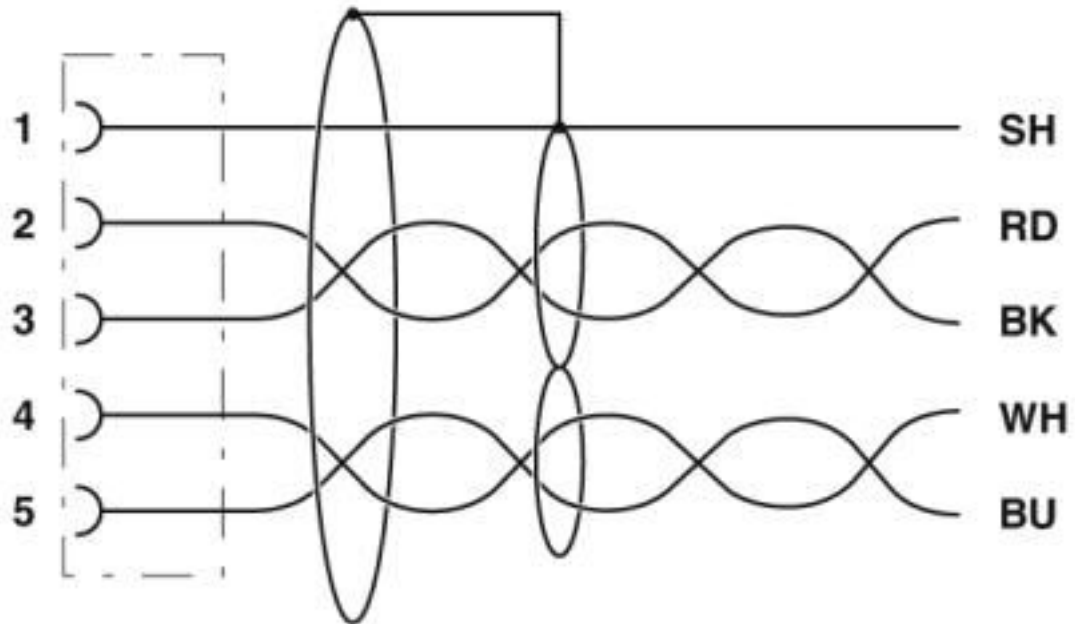

Contact assignment of the M12 socket

Bus system cable - SAC-5P- 5,0-924/FR SCO - 1405982

Schematic diagram

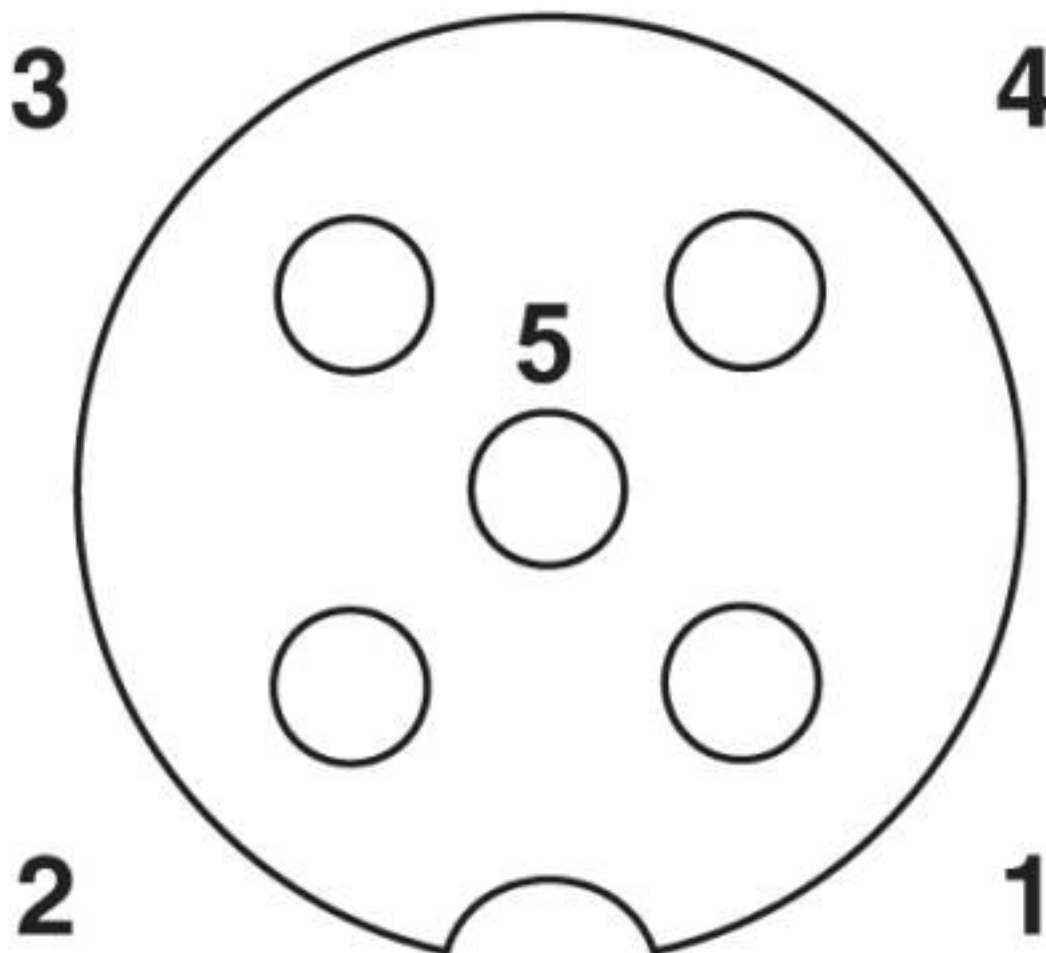

Pin assignment M12 socket, 5-pos., A-coded, socket side view

Bus system cable - SAC-5P- 5,0-924/FR SCO - 1405982

Cable cross section

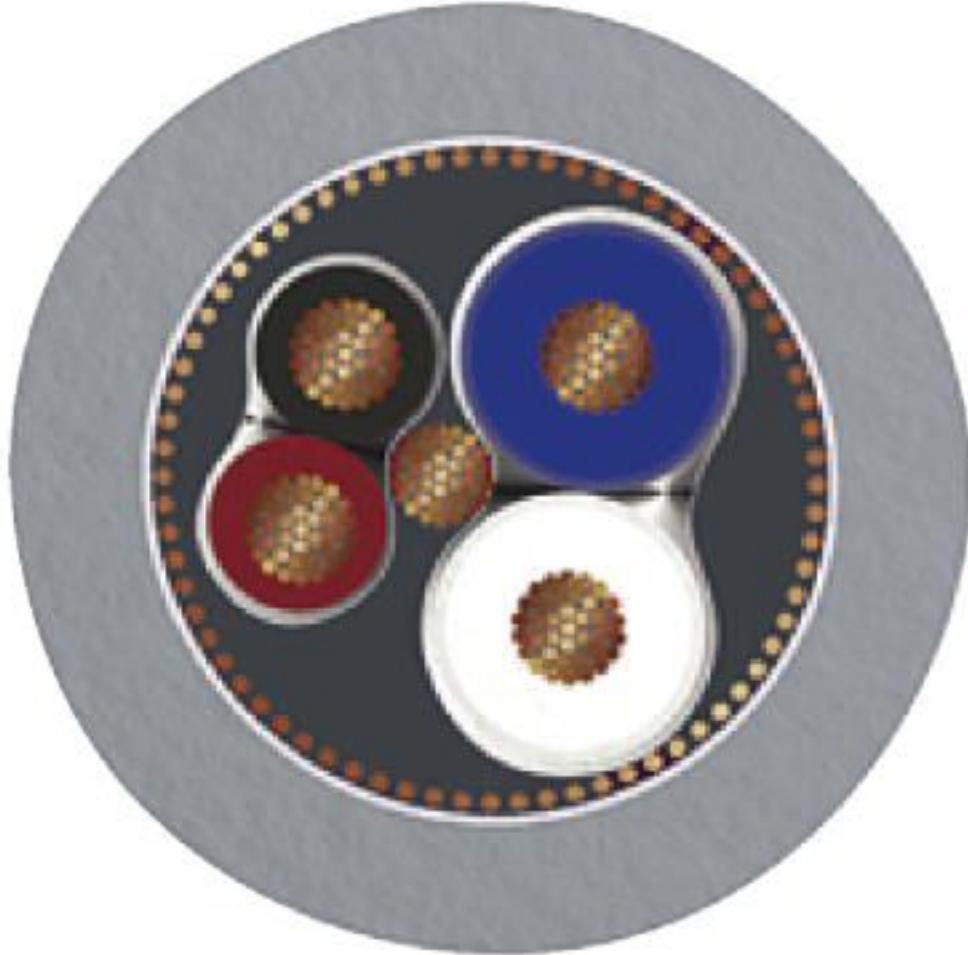

CANopen[®]/DeviceNet[™], PVC, gray [924]

Classifications

eCl@ss

eCl@ss 10.0.1	27060308
eCl@ss 4.0	27060300
eCl@ss 4.1	27060300
eCl@ss 5.0	27060300
eCl@ss 5.1	27060300
eCl@ss 6.0	27279200
eCl@ss 7.0	27279218
eCl@ss 8.0	27279218
eCl@ss 9.0	27060308

Bus system cable - SAC-5P- 5,0-924/FR SCO - 1405982

Classifications

ETIM

ETIM 3.0	EC000830
ETIM 4.0	EC001855
ETIM 5.0	EC002599
ETIM 6.0	EC001855
ETIM 7.0	EC001855

UNSPSC

UNSPSC 6.01	26121616
UNSPSC 7.0901	26121616
UNSPSC 11	26121604
UNSPSC 12.01	26121616
UNSPSC 13.2	31251501
UNSPSC 18.0	26121604
UNSPSC 19.0	26121604
UNSPSC 20.0	26121604
UNSPSC 21.0	26121604

Approvals

Approvals

Approvals

UL Listed / cUL Listed / EAC-RoHS / EAC / cULus Listed

Ex Approvals

Approval details

UL Listed		http://database.ul.com/cgi-bin/XYV/template/LISEXT/1FRAME/index.htm	FILE E 221474
Nominal voltage UN	125 V		
Nominal current IN	4 A		

cUL Listed		http://database.ul.com/cgi-bin/XYV/template/LISEXT/1FRAME/index.htm	FILE E 221474
Nominal voltage UN	125 V		

Bus system cable - SAC-5P- 5,0-924/FR SCO - 1405982

Approvals

Nominal current I _N	4 A
--------------------------------	-----

EAC-RoHS		RU D- DE.HB35.B.00387
----------	---	--------------------------

EAC		RU C- DE.BL08.B.00286
-----	---	--------------------------

cULus Listed		
--------------	---	--

Phoenix Contact 2020 © - all rights reserved
<http://www.phoenixcontact.com>

PHOENIX CONTACT GmbH & Co. KG
Flachsmarktstr. 8
32825 Blomberg
Germany
Tel. +49 5235 300
Fax +49 5235 3 41200
<http://www.phoenixcontact.com>

X-ON Electronics

Largest Supplier of Electrical and Electronic Components

Click to view similar products for [Sensor Cables / Actuator Cables](#) category:

Click to view products by [Phoenix Contact](#) manufacturer:

Other Similar products are found below :

[60963](#) [60964](#) [703000D02F2002](#) [703001D02F0602](#) [703001D02F300](#) [704000D02F120](#) [773032K02F030](#) [802027107404-1](#) [802027213811-1](#)
[804001A09M150](#) [805001A09M0502](#) [84914-0235](#) [84914-0237](#) [885030A09M020](#) [8R4J30E03C3003](#) [1200651332](#) [1200651713](#) [1200660844](#)
[1200660845](#) [1200661173](#) [1200680071](#) [1200720053](#) [1200720081](#) [1200720099](#) [1200720217](#) [1200800231](#) [1200860125](#) [1200870123](#)
[1200980102](#) [1200650267](#) [1200650298](#) [1200660183](#) [1200660782](#) [1200660849](#) [1200661295](#) [1200661297](#) [1200661342](#) [1200661343](#)
[1200670080](#) [1200670220](#) [1200680331](#) [1200720252](#) [1200730184](#) [1200860344](#) [1200870359](#) [1200870643](#) [1200980008](#) [1200980031](#)
[1210502211](#) [1210400542](#)