

Sensor/actuator cable - SAC-8P-MS/ 2,0-542 SH SCO BK - 1406073

Please be informed that the data shown in this PDF Document is generated from our Online Catalog. Please find the complete data in the user's documentation. Our General Terms of Use for Downloads are valid (<http://phoenixcontact.com/download>)



Sensor/actuator cable, 8-position, PVC, yellow, shielded, Plug straight M12, coding: A, on free cable end, cable length: 2 m



Key Commercial Data

| | |
|------------------------|---|
| Packing unit | 1 pc |
| Minimum order quantity | 50 pc |
| GTIN |  4 046356 799744 |
| GTIN | 4046356799744 |

Technical data

Dimensions

| | |
|-----------------|-----|
| Length of cable | 2 m |
|-----------------|-----|

Ambient conditions

| | |
|---------------------------------|----------------------------------|
| Ambient temperature (operation) | -25 °C ... 90 °C (Plug / socket) |
| Degree of protection | IP65 |
| | IP67 |

General

| | |
|------------------------------|-------------------------------|
| Rated current at 40°C | 2 A |
| Rated voltage | 30 V AC |
| | 30 V DC |
| Number of positions | 8 |
| Color handle area | black |
| Insulation resistance | ≥ 100 MΩ |
| Coding | A - standard |
| Standards/regulations | M12 connector IEC 61076-2-101 |
| Status display | No |
| Protective circuit/component | unwired |

Sensor/actuator cable - SAC-8P-MS/ 2,0-542 SH SCO BK - 1406073

Technical data

General

| | |
|-----------------------------|------------------------|
| Overvoltage category | II |
| Degree of pollution | 3 |
| Insertion/withdrawal cycles | ≥ 100 |
| Torque | 0.4 Nm (M12 connector) |

Material

| | |
|--|---|
| Flammability rating according to UL 94 | HB |
| Contact material | CuZn |
| Contact surface material | Ni/Au |
| Contact carrier material | TPU GF |
| Material of grip body | TPU, hardly inflammable, self-extinguishing |
| Material, knurls | Zinc die-cast, nickel-plated |

Standards and Regulations

| | |
|--|-------------------------------|
| Standards/specifications | M12 connector IEC 61076-2-101 |
| Flammability rating according to UL 94 | HB |

Cable

| | |
|---|--|
| Cable type | PVC yellow 105 °C |
| Cable type (abbreviation) | 542 |
| UL AWM style | 2517 (105 °C / 300 V) |
| AWG signal line | 24 |
| Conductor structure signal line | 32x 1.10 mm |
| Core diameter including insulation | 1.12 mm ±0.03 mm |
| Wire colors | white, brown, green, yellow, gray, pink, blue, red |
| Overall twist | 8 wires around filler to the core |
| Shielding | Tinned copper braided shield |
| Optical shield covering | 85 % |
| External sheath, color | yellow |
| External cable diameter D | 6.3 mm ±0.2 mm |
| Minimum bending radius, flexible installation | 12 x D |
| Cable weight | 58 kg/km |
| Outer sheath, material | PVC |
| Material, filler | PP |
| Material conductor insulation | PVC |
| Conductor material | Tin-plated Cu litz wires |
| Insulation resistance | ≥ (550 M Ohms/m @ 500V) |
| Conductor resistance | max. 79.7 Ω/km (20 °C) |
| Nominal voltage, cable | 300 V |
| Flame resistance | FT1, VW-1 |
| Other resistance | UV resistant |
| Ambient temperature (operation) | -30 °C ... 105 °C (cable, fixed installation) |

Sensor/actuator cable - SAC-8P-MS/ 2,0-542 SH SCO BK - 1406073

Technical data

Cable

| | |
|--|---|
| | -5 °C ... 105 °C (cable, flexible installation) |
|--|---|

Environmental Product Compliance

| | |
|------------|---|
| REACH SVHC | Lead 7439-92-1 |
| China RoHS | Environmentally Friendly Use Period = 50 years |
| | For details about hazardous substances go to tab "Downloads", Category "Manufacturer's declaration" |

Drawings

Schematic diagram

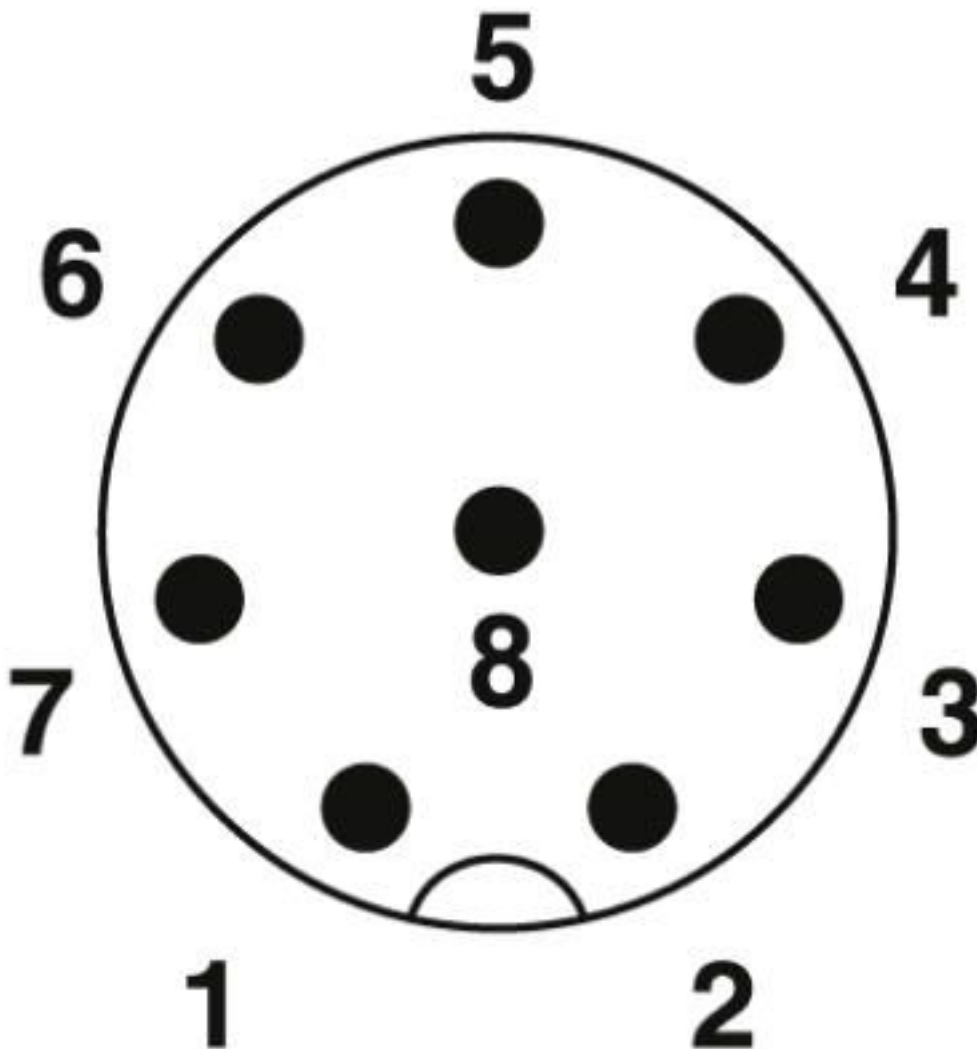

Pin assignment M12 plug, 8-pos., view plug side

Sensor/actuator cable - SAC-8P-MS/ 2,0-542 SH SCO BK - 1406073

Dimensional drawing

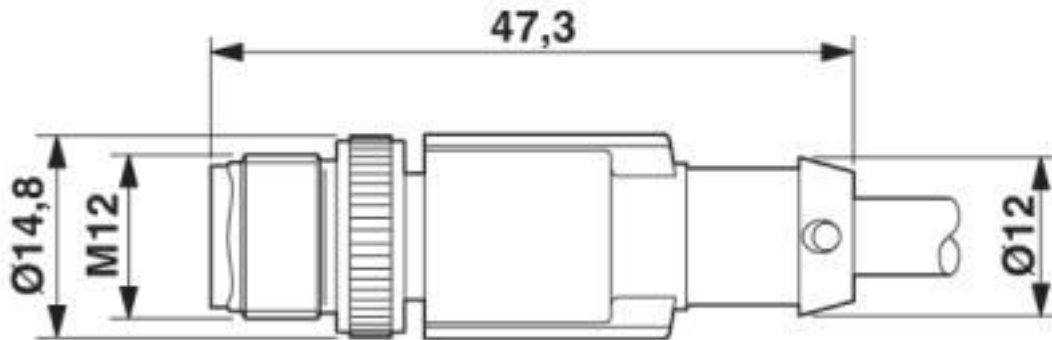

Plug, M12 x 1, straight, shielded

Circuit diagram

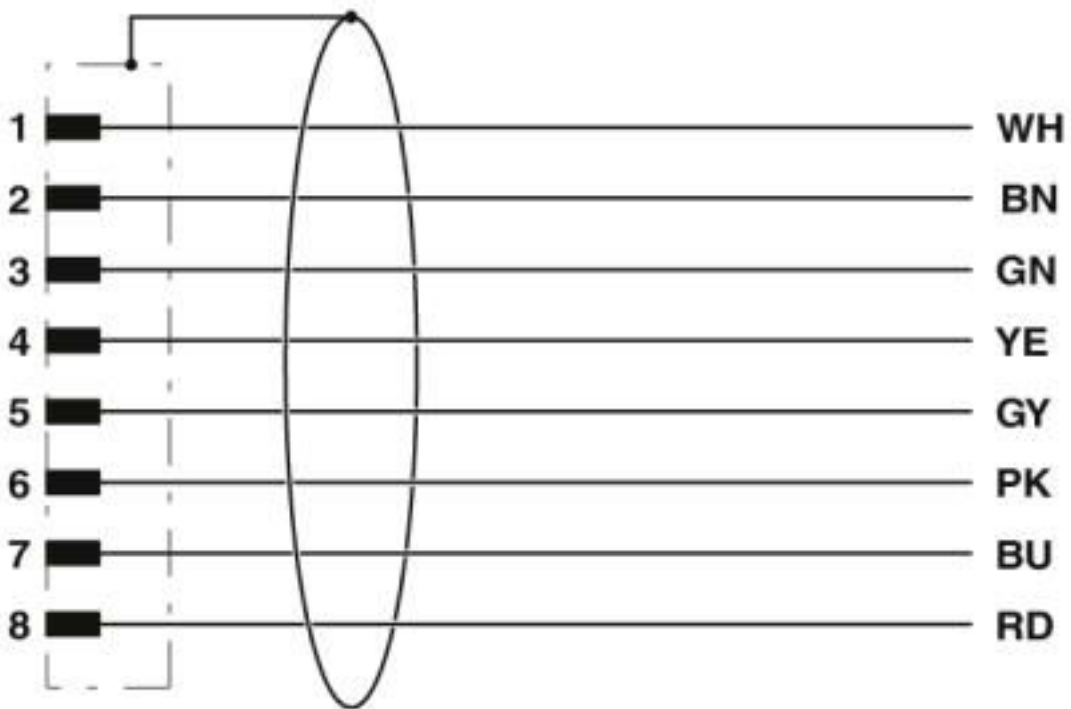

Contact assignment of the M12 plug

Sensor/actuator cable - SAC-8P-MS/ 2,0-542 SH SCO BK - 1406073

Cable cross section



PVC yellow 105 °C [542]

Classifications

eCl@ss

| | |
|---------------|----------|
| eCl@ss 10.0.1 | 27060311 |
| eCl@ss 4.0 | 27060300 |
| eCl@ss 4.1 | 27060300 |
| eCl@ss 5.0 | 27061800 |
| eCl@ss 5.1 | 27061800 |
| eCl@ss 6.0 | 27279200 |
| eCl@ss 7.0 | 27279218 |
| eCl@ss 8.0 | 27279218 |
| eCl@ss 9.0 | 27060311 |

Sensor/actuator cable - SAC-8P-MS/ 2,0-542 SH SCO BK - 1406073

Classifications

ETIM

| | |
|----------|----------|
| ETIM 3.0 | EC001855 |
| ETIM 4.0 | EC001855 |
| ETIM 5.0 | EC001855 |
| ETIM 6.0 | EC001855 |
| ETIM 7.0 | EC001855 |

UNSPSC

| | |
|---------------|----------|
| UNSPSC 6.01 | 31251501 |
| UNSPSC 7.0901 | 31251501 |
| UNSPSC 11 | 31251501 |
| UNSPSC 12.01 | 31251501 |
| UNSPSC 13.2 | 31251501 |
| UNSPSC 19.0 | 31251501 |
| UNSPSC 20.0 | 31251501 |
| UNSPSC 21.0 | 31251501 |

Approvals

Approvals

Approvals

UL Listed / cUL Listed / EAC-RoHS / EAC / cULus Listed

Ex Approvals

Approval details

| | | | |
|--------------------|---|---|---------------|
| UL Listed |  | http://database.ul.com/cgi-bin/XYV/template/LISEXT/1FRAME/index.htm | FILE E 221474 |
| Nominal voltage UN | 30 V | | |
| Nominal current IN | 2 A | | |

| | | | |
|--------------------|---|---|---------------|
| cUL Listed |  | http://database.ul.com/cgi-bin/XYV/template/LISEXT/1FRAME/index.htm | FILE E 221474 |
| Nominal voltage UN | 30 V | | |
| Nominal current IN | 2 A | | |

Sensor/actuator cable - SAC-8P-MS/ 2,0-542 SH SCO BK - 1406073

Approvals

| | | |
|----------|---|--------------------------|
| EAC-RoHS |  | RU D- DE.HB35.B.00387 |
|----------|---|--------------------------|

| | | |
|-----|---|--------------------------|
| EAC |  | RU C- DE.BL08.B.00286 |
|-----|---|--------------------------|

| | | |
|--------------|---|--|
| cULus Listed |  | |
|--------------|---|--|

Phoenix Contact 2020 © - all rights reserved
<http://www.phoenixcontact.com>

PHOENIX CONTACT GmbH & Co. KG
Flachsmarktstr. 8
32825 Blomberg
Germany
Tel. +49 5235 300
Fax +49 5235 3 41200
<http://www.phoenixcontact.com>

X-ON Electronics

Largest Supplier of Electrical and Electronic Components

Click to view similar products for [Sensor Cables / Actuator Cables](#) category:

Click to view products by [Phoenix Contact](#) manufacturer:

Other Similar products are found below :

[60963](#) [60964](#) [703000D02F2002](#) [703001D02F0602](#) [703001D02F300](#) [704000D02F120](#) [773032K02F030](#) [802027107404-1](#) [802027213811-1](#)
[804001A09M150](#) [805001A09M0502](#) [84914-0235](#) [84914-0237](#) [885030A09M020](#) [8R4J30E03C3003](#) [1200651332](#) [1200651713](#) [1200660844](#)
[1200660845](#) [1200661173](#) [1200680071](#) [1200720053](#) [1200720081](#) [1200720099](#) [1200720217](#) [1200800231](#) [1200860125](#) [1200870123](#)
[1200980102](#) [1200650267](#) [1200650298](#) [1200660183](#) [1200660782](#) [1200660849](#) [1200661295](#) [1200661297](#) [1200661342](#) [1200661343](#)
[1200670080](#) [1200670220](#) [1200680331](#) [1200720252](#) [1200730184](#) [1200860344](#) [1200870359](#) [1200870643](#) [1200980008](#) [1200980031](#)
[1210502211](#) [1210400542](#)