

Sensor/actuator cable - SAC-4P-M8MR/ 2,0-542 BK - 1406214

Please be informed that the data shown in this PDF Document is generated from our Online Catalog. Please find the complete data in the user's documentation. Our General Terms of Use for Downloads are valid (<http://phoenixcontact.com/download>)



Sensor/actuator cable, 4-position, PVC, yellow, Plug angled M8, on free cable end, cable length: 2 m



Key Commercial Data

Packing unit	1 pc
Minimum order quantity	50 pc
GTIN	 4 046356 798365
GTIN	4046356798365

Technical data

Dimensions

Length of cable	2 m
-----------------	-----

Ambient conditions

Ambient temperature (operation)	-25 °C ... 90 °C (Plug / socket)
Degree of protection	IP65
	IP67
	IP68

General

Rated current at 40°C	4 A
Rated voltage	48 V AC
	60 V DC
Number of positions	4
Insulation resistance	≥ 100 MΩ
Coding	A - standard
Status display	No
Protective circuit/component	unwired
Overvoltage category	II

Sensor/actuator cable - SAC-4P-M8MR/ 2,0-542 BK - 1406214

Technical data

General

Degree of pollution	3
Insertion/withdrawal cycles	≥ 100
Torque	0.2 Nm (M8 connectors)

Material

Flammability rating according to UL 94	HB
Contact material	CuSn
Contact surface material	Ni/Au
Contact carrier material	TPU GF
Material of grip body	TPU, hardly inflammable, self-extinguishing
Material, knurls	Zinc die-cast, nickel-plated

Standards and Regulations

Flammability rating according to UL 94	HB
--	----

Cable

Cable type	PVC yellow 105 °C
Cable type (abbreviation)	542
UL AWM style	2517 (105 °C / 300 V)
AWG signal line	24
Conductor structure signal line	32x 1.10 mm
Core diameter including insulation	1.12 mm ±0.03 mm
Wire colors	brown, blue, black, white
Overall twist	4 wires, twisted
External sheath, color	yellow
External cable diameter D	4.4 mm ±0.2 mm
Minimum bending radius, flexible installation	8 x D
Cable weight	25 kg/km
Outer sheath, material	PVC
Material conductor insulation	PVC
Conductor material	Tin-plated Cu litz wires
Insulation resistance	≥ (550 M Ohms/m @ 500V)
Conductor resistance	max. 79.7 Ω/km (20 °C)
Nominal voltage, cable	300 V
Flame resistance	FT4
Other resistance	UV resistant
Ambient temperature (operation)	-30 °C ... 105 °C (cable, fixed installation)
	-5 °C ... 105 °C (cable, flexible installation)

Environmental Product Compliance

REACH SVHC	Lead 7439-92-1
China RoHS	Environmentally Friendly Use Period = 50 years

Sensor/actuator cable - SAC-4P-M8MR/ 2,0-542 BK - 1406214

Technical data

Environmental Product Compliance

	For details about hazardous substances go to tab "Downloads", Category "Manufacturer's declaration"
--	---

Drawings

Dimensional drawing

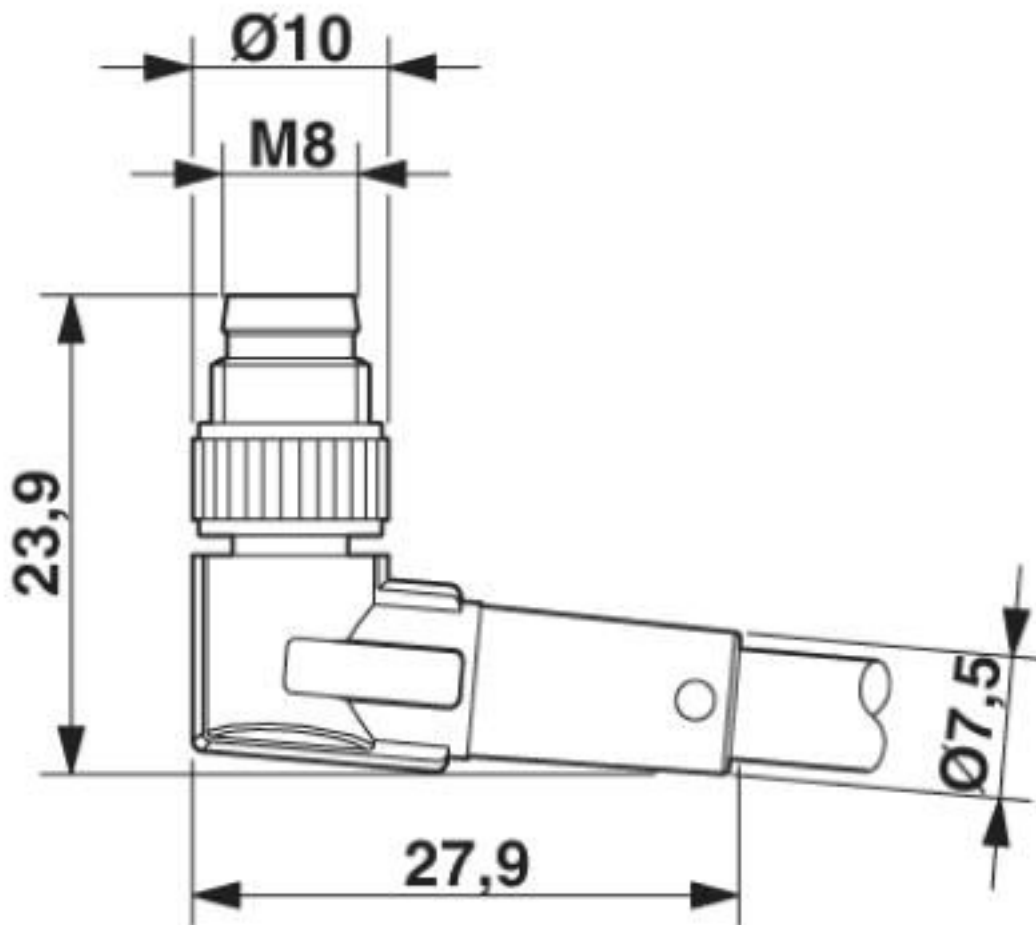

M8 x 1 male plug, angled version

Sensor/actuator cable - SAC-4P-M8MR/ 2,0-542 BK - 1406214

Circuit diagram



Contact assignment of the M8 plug

Sensor/actuator cable - SAC-4P-M8MR/ 2,0-542 BK - 1406214

Schematic diagram



Pin assignment M8 plug, 4-pos., view male side

Sensor/actuator cable - SAC-4P-M8MR/ 2,0-542 BK - 1406214

Schematic diagram

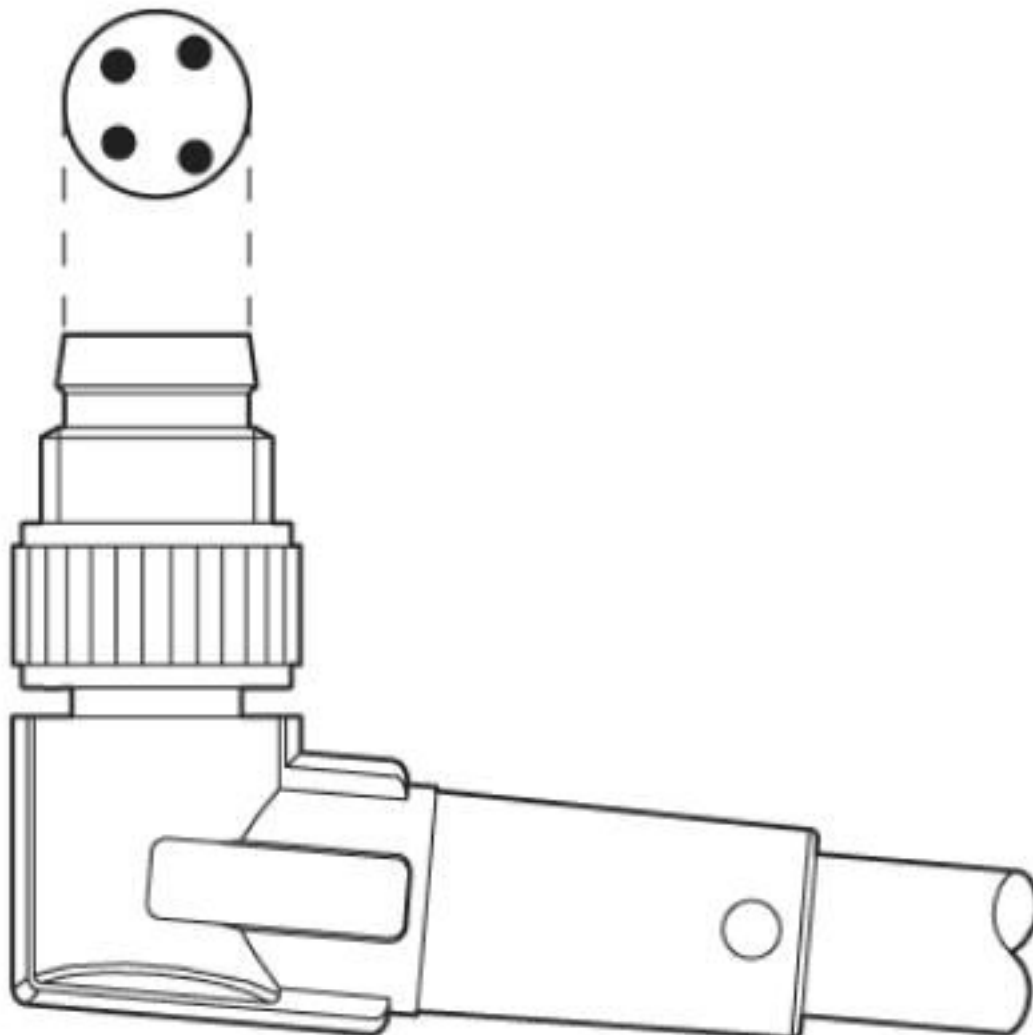

Layout of connector pin assignments

Sensor/actuator cable - SAC-4P-M8MR/ 2,0-542 BK - 1406214

Cable cross section

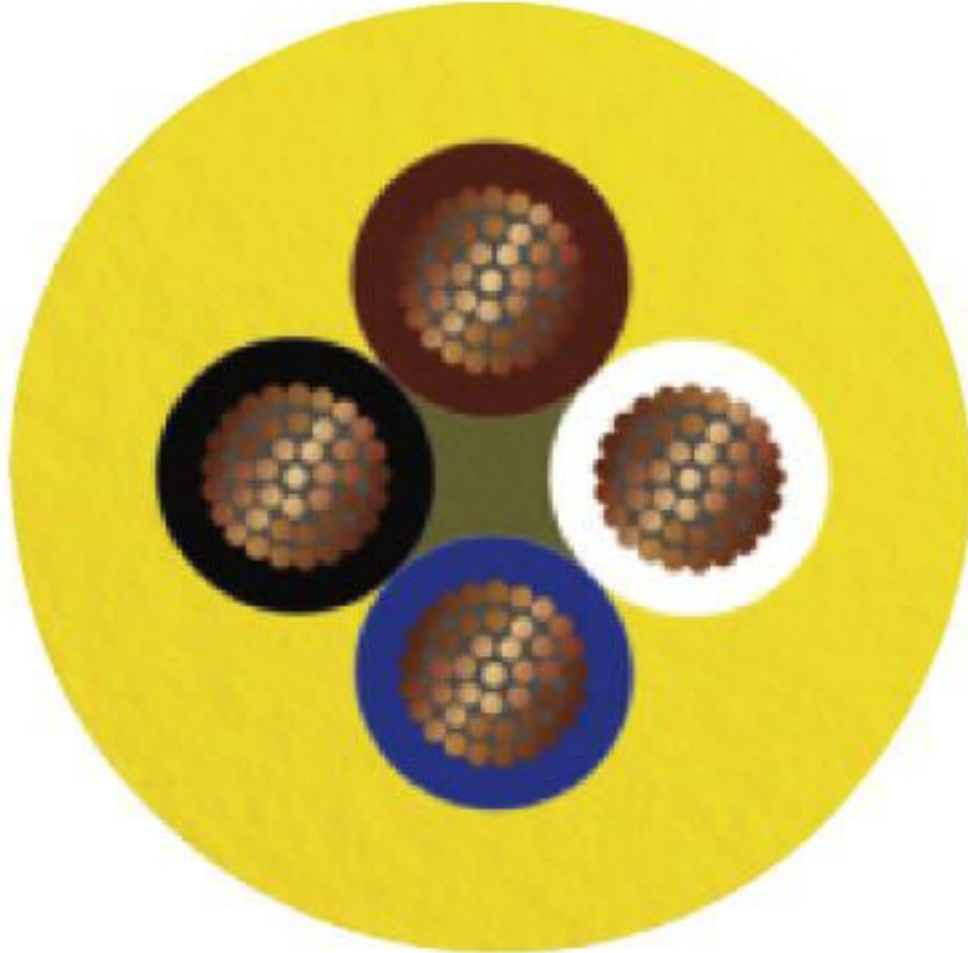

PVC yellow 105 °C [542]

Classifications

eCl@ss

eCl@ss 10.0.1	27060311
eCl@ss 4.0	27060300
eCl@ss 4.1	27060300
eCl@ss 5.0	27061800
eCl@ss 5.1	27061800
eCl@ss 6.0	27279200
eCl@ss 7.0	27279218
eCl@ss 8.0	27279218
eCl@ss 9.0	27060311

Sensor/actuator cable - SAC-4P-M8MR/ 2,0-542 BK - 1406214

Classifications

ETIM

ETIM 3.0	EC001855
ETIM 4.0	EC001855
ETIM 5.0	EC001855
ETIM 6.0	EC001855
ETIM 7.0	EC001855

UNSPSC

UNSPSC 6.01	31251501
UNSPSC 7.0901	31251501
UNSPSC 11	31251501
UNSPSC 12.01	31251501
UNSPSC 13.2	31251501
UNSPSC 19.0	31251501
UNSPSC 20.0	31251501
UNSPSC 21.0	31251501

Approvals

Approvals

Approvals

UL Listed / cUL Listed / EAC-RoHS / EAC / cULus Listed

Ex Approvals

Approval details

UL Listed		http://database.ul.com/cgi-bin/XYV/template/LISEXT/1FRAME/index.htm	FILE E 221474
Nominal voltage UN	30 V		
Nominal current IN	4 A		

cUL Listed		http://database.ul.com/cgi-bin/XYV/template/LISEXT/1FRAME/index.htm	FILE E 221474
Nominal voltage UN	30 V		
Nominal current IN	4 A		

Sensor/actuator cable - SAC-4P-M8MR/ 2,0-542 BK - 1406214

Approvals

EAC-RoHS		RU D- DE.HB35.B.00387
----------	--	--------------------------

EAC		RU C- DE.BL08.B.00286
-----	--	--------------------------

cULus Listed		
--------------	--	--

Accessories

Accessories

Protective cap

Sealing cap - PROT-M 8 FS-PA-CHAIN - 1430857

M8 sealing cap made of plastic with fixing band for sensor cables, for M8 plugs



Screwdriver tools

Tool - SAC BIT M8-D10 - 1208461



Nut for assembling M8 connectors with longitudinal knurl and a knurl diameter of 10 mm, for 4 mm hexagonal drive

Torque tool

Torque screwdriver - TSD 02 SAC - 1208487



Torque screwdriver, with preset torque of 0.2 Nm and 4 mm hexagonal drive for M8 connectors

Phoenix Contact 2020 © - all rights reserved
<http://www.phoenixcontact.com>

PHOENIX CONTACT GmbH & Co. KG
Flachmarktstr. 8
32825 Blomberg
Germany
Tel. +49 5235 300
Fax +49 5235 3 41200
<http://www.phoenixcontact.com>

X-ON Electronics

Largest Supplier of Electrical and Electronic Components

Click to view similar products for [Sensor Cables / Actuator Cables](#) category:

Click to view products by [Phoenix Contact](#) manufacturer:

Other Similar products are found below :

[60963](#) [60964](#) [703000D02F2002](#) [703001D02F0602](#) [703001D02F300](#) [704000D02F120](#) [773032K02F030](#) [802027107404-1](#) [802027213811-1](#)
[804001A09M150](#) [805001A09M0502](#) [84914-0235](#) [84914-0237](#) [885030A09M020](#) [8R4J30E03C3003](#) [1200651332](#) [1200651713](#) [1200660844](#)
[1200660845](#) [1200661173](#) [1200680071](#) [1200720053](#) [1200720081](#) [1200720099](#) [1200720217](#) [1200800231](#) [1200860125](#) [1200870123](#)
[1200980102](#) [1200650267](#) [1200650298](#) [1200660183](#) [1200660782](#) [1200660849](#) [1200661295](#) [1200661297](#) [1200661342](#) [1200661343](#)
[1200670080](#) [1200670220](#) [1200680331](#) [1200720252](#) [1200730184](#) [1200860344](#) [1200870359](#) [1200870643](#) [1200980008](#) [1200980031](#)
[1210502211](#) [1210400542](#)