

# Sensor/actuator cable - SAC-4P-MR/0,5-542/M8 FR SCO BK - 1406230

Please be informed that the data shown in this PDF Document is generated from our Online Catalog. Please find the complete data in the user's documentation. Our General Terms of Use for Downloads are valid (<http://phoenixcontact.com/download>)



Sensor/actuator cable, 4-position, PVC, yellow, Plug angled M12 SPEEDCON, coding: A, on Socket angled M8, cable length: 0.5 m



## Key Commercial Data

Packing unit	1 pc
Minimum order quantity	50 pc
GTIN	 4 046356 798211
GTIN	4046356798211

## Technical data

### Dimensions

Length of cable	0.5 m
-----------------	-------

### Ambient conditions

Ambient temperature (operation)	-25 °C ... 90 °C (Plug / socket)
Degree of protection	IP65
	IP67
	IP68

### General

Rated current at 40°C	4 A
Rated voltage	48 V AC
	60 V DC
Number of positions	4
Insulation resistance	≥ 100 MΩ
Coding	A - standard
Standards/regulations	M12 connector IEC 61076-2-101
	M8 connector IEC 61076-2-104
Status display	No

# Sensor/actuator cable - SAC-4P-MR/0,5-542/M8 FR SCO BK - 1406230

## Technical data

### General

Protective circuit/component	unwired
Overvoltage category	II
Degree of pollution	3
Insertion/withdrawal cycles	≥ 100
Torque	0.4 Nm (M12 connector)
	0.2 Nm (M8 connectors)

### Material

Flammability rating according to UL 94	HB
Contact material	CuSn
Contact surface material	Ni/Au
Contact carrier material	TPU GF
Material of grip body	TPU, hardly inflammable, self-extinguishing
Material, knurls	Zinc die-cast, nickel-plated
Sealing material	NBR

### Standards and Regulations

Standards/specifications	M12 connector IEC 61076-2-101
	M8 connector IEC 61076-2-104
Flammability rating according to UL 94	HB

### Cable

Cable type	PVC yellow 105 °C
Cable type (abbreviation)	542
UL AWM style	2517 (105 °C / 300 V)
AWG signal line	24
Conductor structure signal line	32x 1.10 mm
Core diameter including insulation	1.12 mm ±0.03 mm
Wire colors	brown, blue, black, white
Overall twist	4 wires, twisted
External sheath, color	yellow
External cable diameter D	4.4 mm ±0.2 mm
Minimum bending radius, flexible installation	8 x D
Cable weight	25 kg/km
Outer sheath, material	PVC
Material conductor insulation	PVC
Conductor material	Tin-plated Cu litz wires
Insulation resistance	≥ (550 M Ohms/m @ 500V)
Conductor resistance	max. 79.7 Ω/km (20 °C)
Nominal voltage, cable	300 V
Flame resistance	FT4
Other resistance	UV resistant

# Sensor/actuator cable - SAC-4P-MR/0,5-542/M8 FR SCO BK - 1406230

## Technical data

### Cable

Ambient temperature (operation)	-30 °C ... 105 °C (cable, fixed installation)
	-5 °C ... 105 °C (cable, flexible installation)

### Environmental Product Compliance

China RoHS	Environmentally friendly use period: unlimited = EFUP-e
	No hazardous substances above threshold values

## Drawings

Dimensional drawing

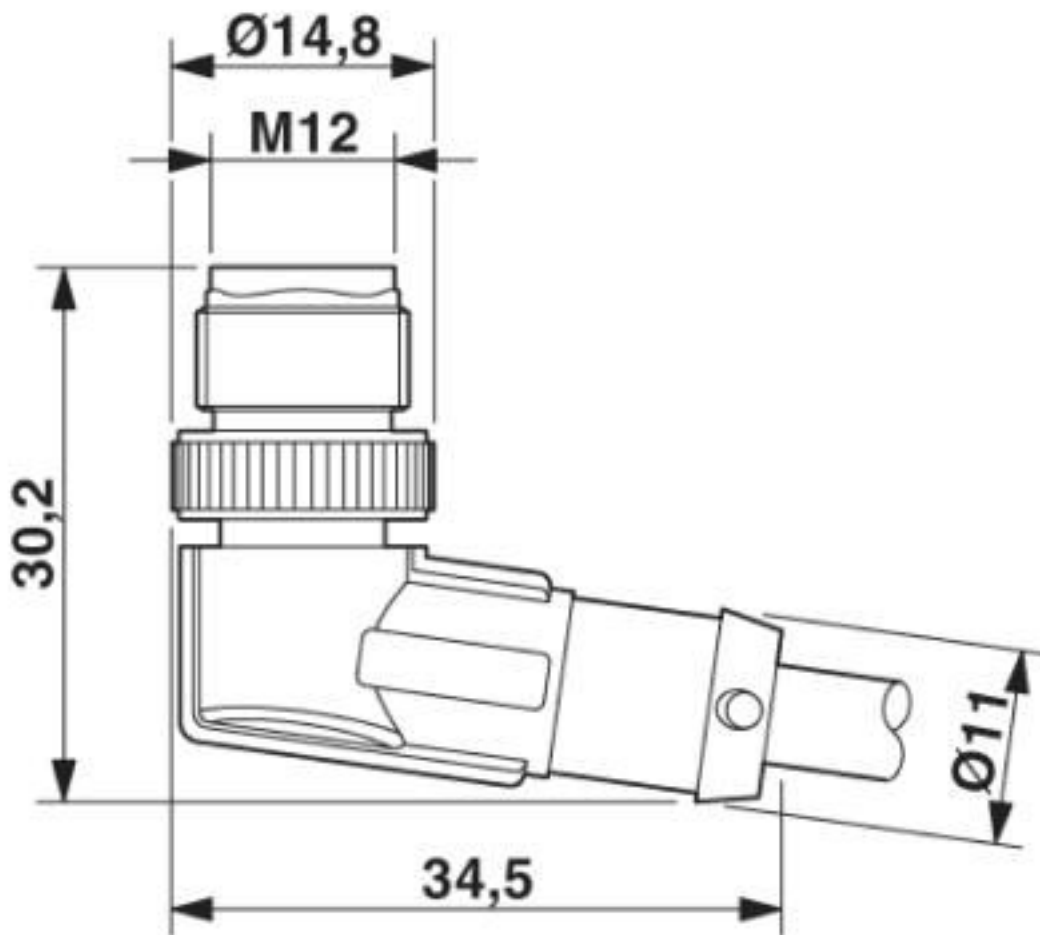

M12 x 1 male plug, angled

# Sensor/actuator cable - SAC-4P-MR/0,5-542/M8 FR SCO BK - 1406230

Dimensional drawing

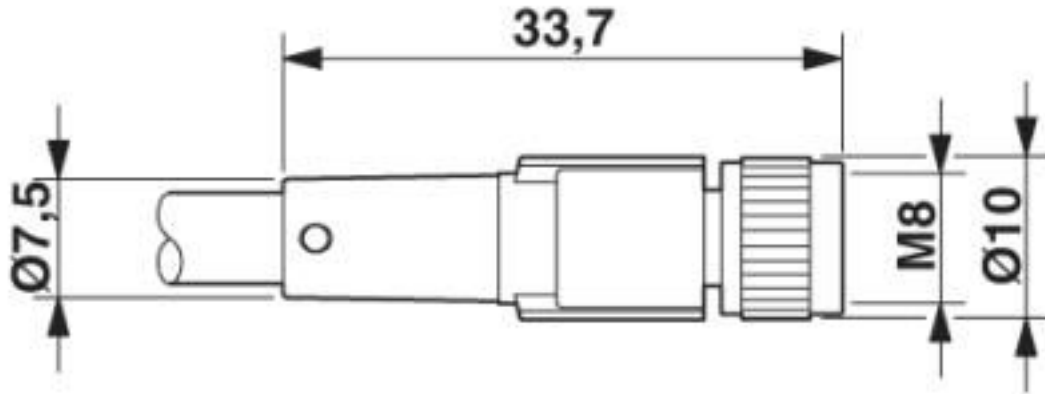

Socket M8 x 1, straight

Circuit diagram

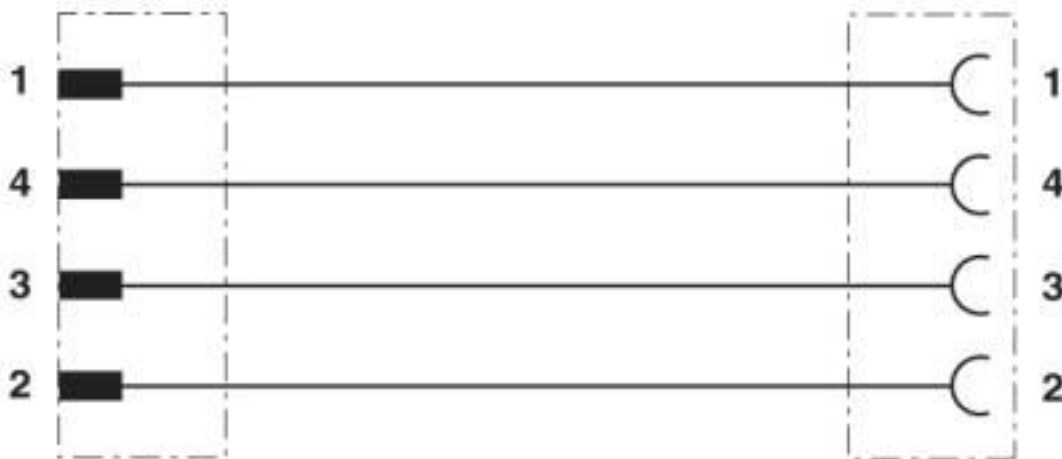

Contact assignment of M12 plugs / M8 sockets

# Sensor/actuator cable - SAC-4P-MR/0,5-542/M8 FR SCO BK - 1406230

Schematic diagram

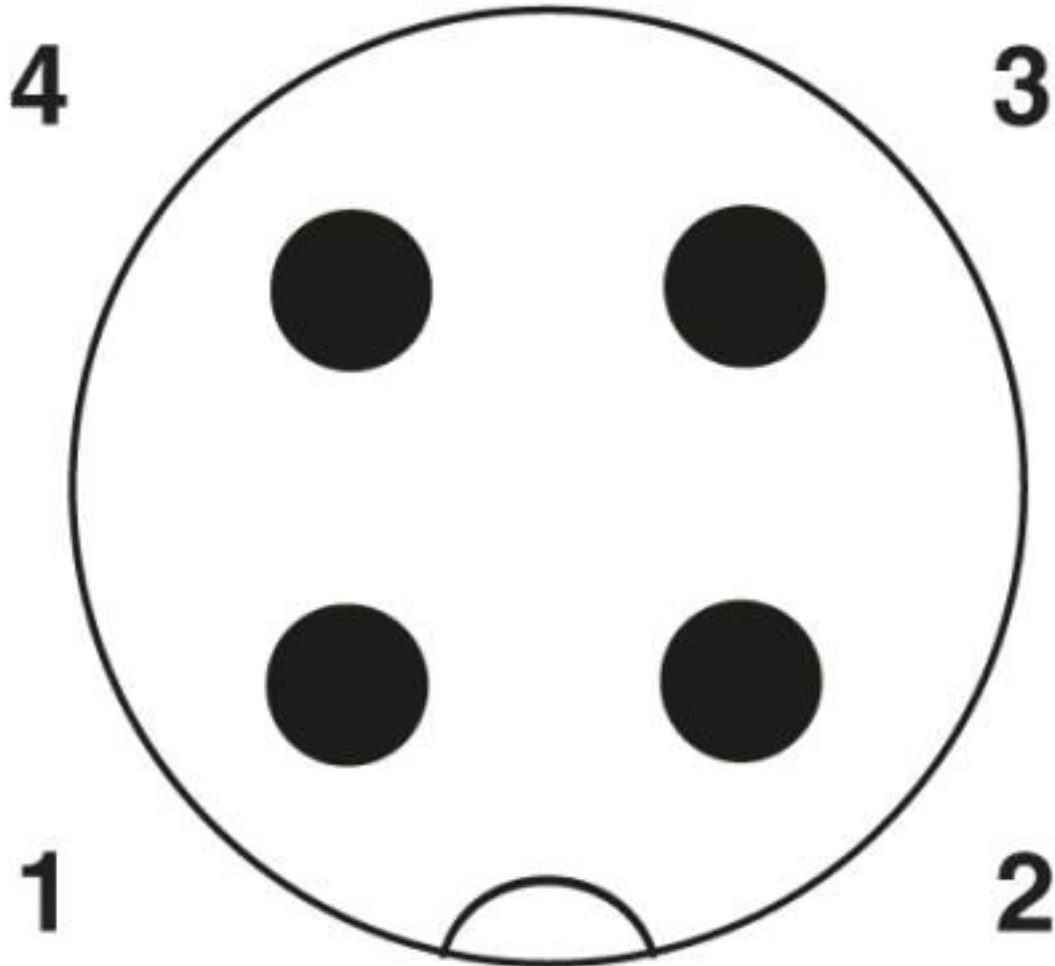

Pin assignment M12 plug, 4-pos., A-coded, view plug side

## Sensor/actuator cable - SAC-4P-MR/0,5-542/M8 FR SCO BK - 1406230

Schematic diagram

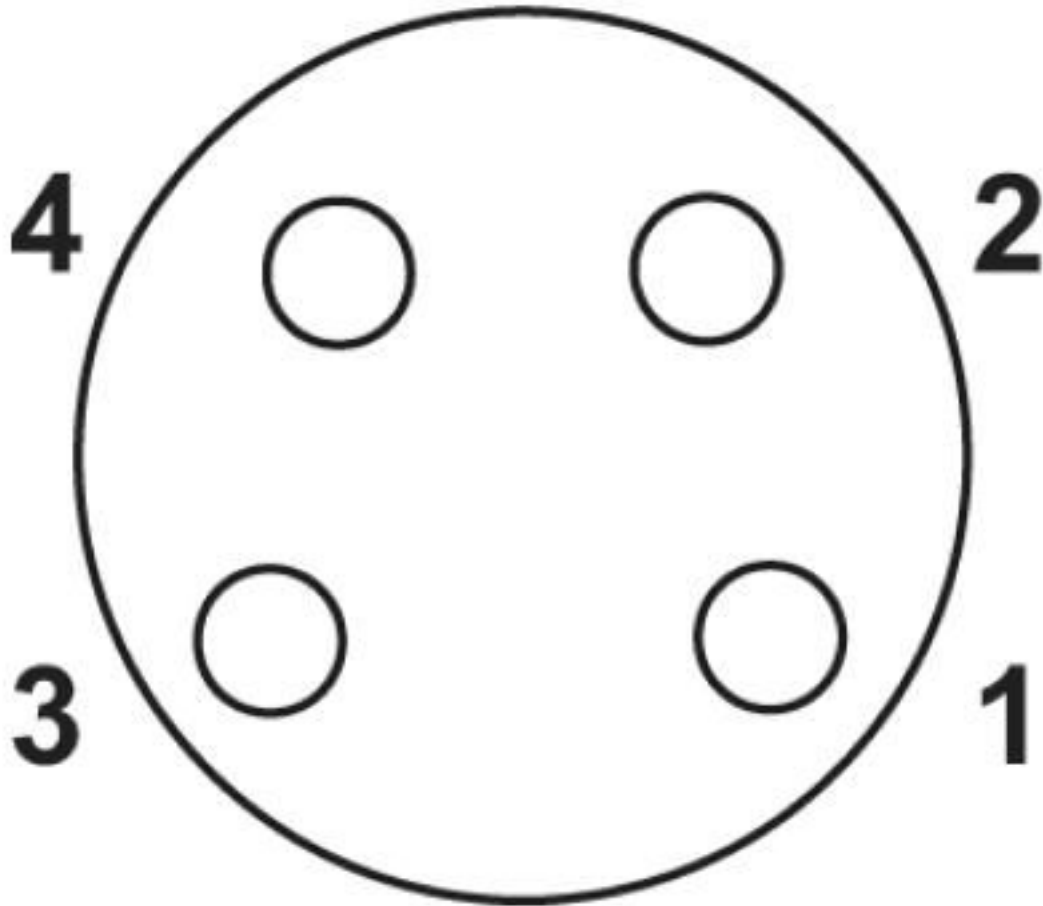

Pin assignment M8 socket, 4-pos., view female side

# Sensor/actuator cable - SAC-4P-MR/0,5-542/M8 FR SCO BK - 1406230

Cable cross section

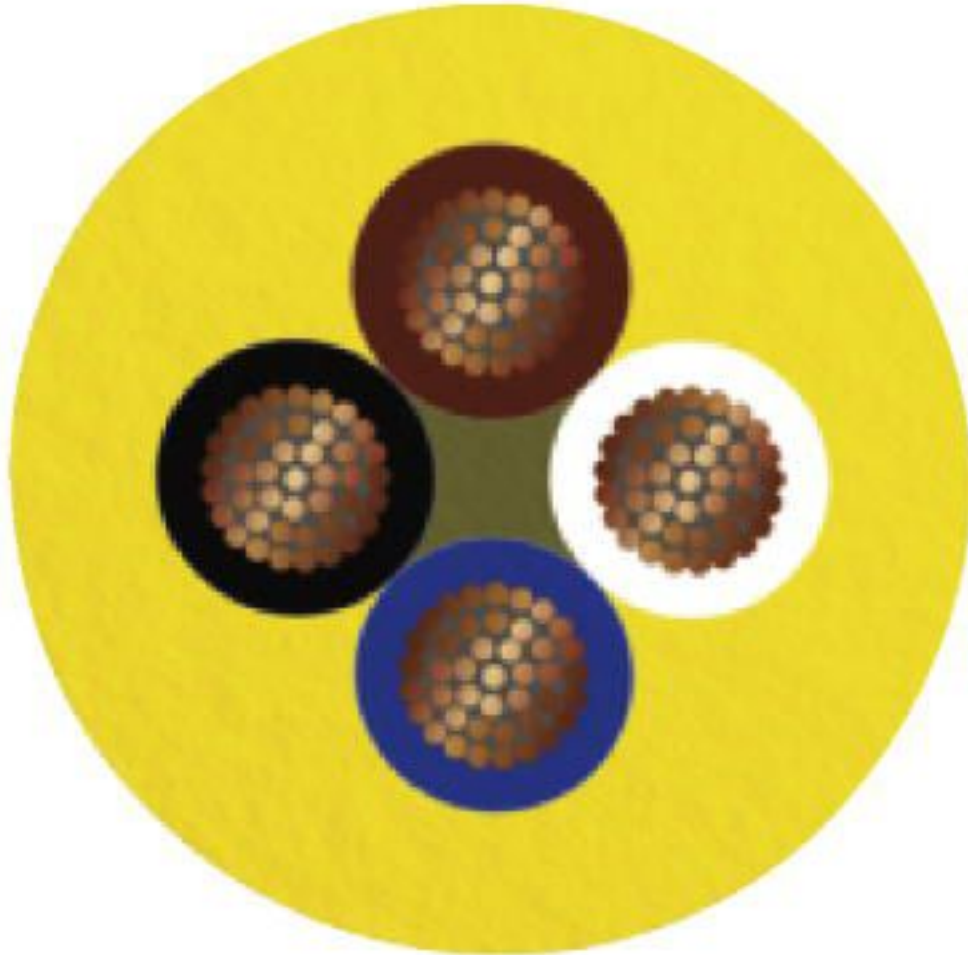

PVC yellow 105 °C [542]

## Classifications

eCl@ss

eCl@ss 10.0.1	27060311
eCl@ss 4.0	27060300
eCl@ss 4.1	27060300
eCl@ss 5.0	27061800
eCl@ss 5.1	27061800
eCl@ss 6.0	27279200
eCl@ss 7.0	27279218
eCl@ss 8.0	27279218
eCl@ss 9.0	27060311

# Sensor/actuator cable - SAC-4P-MR/0,5-542/M8 FR SCO BK - 1406230

## Classifications

### ETIM

ETIM 3.0	EC001855
ETIM 4.0	EC001855
ETIM 5.0	EC001855
ETIM 6.0	EC001855
ETIM 7.0	EC001855

### UNSPSC

UNSPSC 6.01	31251501
UNSPSC 7.0901	31251501
UNSPSC 11	31251501
UNSPSC 12.01	31251501
UNSPSC 13.2	31251501
UNSPSC 19.0	31251501
UNSPSC 20.0	31251501
UNSPSC 21.0	31251501

## Approvals

### Approvals

#### Approvals

UL Listed / cUL Listed / EAC-RoHS / EAC / cULus Listed

#### Ex Approvals

### Approval details

UL Listed		<a href="http://database.ul.com/cgi-bin/XYV/template/LISEXT/1FRAME/index.htm">http://database.ul.com/cgi-bin/XYV/template/LISEXT/1FRAME/index.htm</a>	FILE E 221474
Nominal voltage UN	30 V		
Nominal current IN	4 A		

cUL Listed		<a href="http://database.ul.com/cgi-bin/XYV/template/LISEXT/1FRAME/index.htm">http://database.ul.com/cgi-bin/XYV/template/LISEXT/1FRAME/index.htm</a>	FILE E 221474
Nominal voltage UN	30 V		
Nominal current IN	4 A		



# Sensor/actuator cable - SAC-4P-MR/0,5-542/M8 FR SCO BK - 1406230

## Approvals

EAC-RoHS		RU D- DE.HB35.B.00387
----------	--	--------------------------

EAC		RU C- DE.BL08.B.00286
-----	--	--------------------------

cULus Listed		
--------------	--	--

## Accessories

### Accessories

#### Plug for cable screw gland

Screw plug - PROT-M 8 MS-PA-CHAIN - 1430860

M8 sealing cap made of plastic with fixing band for sensor cables, for M8 sockets



#### Protective cap

Sealing cap - PROT-M12 FS-PA-CHAIN - 1430873

M12 sealing cap made of plastic with fixing band, for sensor cables, for free M12 plugs



#### Safety locking

Locking clip - SAC-M12-EXCLIP-M - 1558988



Locking clip for the pin side of sensor/actuator cables with M12 connector and M12 connectors for assembly, for knurl diameter: 15 mm or for Allen key with a wrench size of 14 mm, prevents the disconnection of plug-in connections without tools

#### Screwdriver tools

## Sensor/actuator cable - SAC-4P-MR/0,5-542/M8 FR SCO BK - 1406230

### Accessories

Tool - SAC BIT M8-D10 - 1208461



Nut for assembling M8 connectors with longitudinal knurl and a knurl diameter of 10 mm, for 4 mm hexagonal drive

---

Adapter insert - TSD-M SAC-BIT ADAPTER - 1212600



Adapter bit for TSD-M...torque tools, E6.3-1/4" drive with 4 mm hexagon to accommodate SAC bits

---

Tool - SAC BIT M12-D15 - 1208432



Nut for assembling sensor/actuator cables with M12 connector and M12 connectors for assembly, with a knurl diameter of 15 mm, for 4 mm hexagonal drive

---

### Torque tool

Torque screwdriver - TSD 02 SAC - 1208487



Torque screwdriver, with preset torque of 0.2 Nm and 4 mm hexagonal drive for M8 connectors

---

Torque screwdriver - TSD 04 SAC - 1208429



Torque screwdriver, with preset torque of 0.4 Nm and 4 mm hexagonal drive for M12 connectors

---

## Sensor/actuator cable - SAC-4P-MR/0,5-542/M8 FR SCO BK - 1406230

### Accessories

Torque screwdriver - TSD-M 1,2NM - 1212224



Torque screw driver, accuracy as per EN ISO 6789 standard, adjustable from 0.3 - 1.2 Nm

---

Phoenix Contact 2020 © - all rights reserved  
<http://www.phoenixcontact.com>

PHOENIX CONTACT GmbH & Co. KG  
Flachsmarktstr. 8  
32825 Blomberg  
Germany  
Tel. +49 5235 300  
Fax +49 5235 3 41200  
<http://www.phoenixcontact.com>

## X-ON Electronics

Largest Supplier of Electrical and Electronic Components

*Click to view similar products for [Sensor Cables / Actuator Cables](#) category:*

*Click to view products by [Phoenix Contact](#) manufacturer:*

Other Similar products are found below :

[60963](#) [60964](#) [703000D02F2002](#) [703001D02F0602](#) [703001D02F300](#) [704000D02F120](#) [773032K02F030](#) [802027107404-1](#) [802027213811-1](#)  
[804001A09M150](#) [805001A09M0502](#) [84914-0235](#) [84914-0237](#) [885030A09M020](#) [8R4J30E03C3003](#) [1200651332](#) [1200651713](#) [1200660844](#)  
[1200660845](#) [1200661173](#) [1200680071](#) [1200720053](#) [1200720081](#) [1200720099](#) [1200720217](#) [1200800231](#) [1200860125](#) [1200870123](#)  
[1200980102](#) [1200650267](#) [1200650298](#) [1200660183](#) [1200660782](#) [1200660849](#) [1200661295](#) [1200661297](#) [1200661342](#) [1200661343](#)  
[1200670080](#) [1200670220](#) [1200680331](#) [1200720252](#) [1200730184](#) [1200860344](#) [1200870359](#) [1200870643](#) [1200980008](#) [1200980031](#)  
[1210502211](#) [1210400542](#)