

Patch cable - VS-PNRJ45-PNRJ45-93B-0,5 - 1406398

Please be informed that the data shown in this PDF Document is generated from our Online Catalog. Please find the complete data in the user's documentation. Our General Terms of Use for Downloads are valid (<http://phoenixcontact.com/download>)



PROFINET patch cable, shielded, star quad, 22 AWG stranded (7-wire), green, straight RJ45 plug/IP20 to straight RJ45 plug/IP20, length: 0.5 m

PROFINET patch cable



Key Commercial Data

Packing unit	1 pc
GTIN	
GTIN	4046356763417

Technical data

Dimensions

Length of cable	0.50 m
-----------------	--------

General data

Number of positions	4
Overvoltage category	I
Locking type	Push Pull
Rated voltage (III/3)	72 V (DC)
Degree of protection	IP20

Characteristics head 1

Shielded	yes
----------	-----

Cable

Cable type	PROFINET PVC stranded CAT5
Cable type (abbreviation)	93B
Signal type/category	PROFINET CAT5 (IEC 11801:2002), 100 Mbps
Cable structure	1x4xAWG22/7; SF/TQ
Conductor cross section	4x 0.34 mm ²
AWG signal line	22

Patch cable - VS-PNRJ45-PNRJ45-93B-0,5 - 1406398

Technical data

Cable

Conductor structure signal line	7x 0.25 mm
Core diameter including insulation	approx. 1.5 mm
Wire colors	White, yellow, blue, orange
External sheath, color	green RAL 6018
External cable diameter D	6.5 mm
Smallest bending radius, fixed installation	60 mm
Smallest bending radius, movable installation	30 mm
Outer sheath, material	PVC
Conductor material	Tin-plated Cu litz wires
Wave impedance	100 Ω \pm 15 Ω (at 1 ... 100 MHz)

Environmental Product Compliance

China RoHS	Environmentally friendly use period: unlimited = EFUP-e
	No hazardous substances above threshold values

Drawings

Patch cable - VS-PNRJ45-PNRJ45-93B-0,5 - 1406398

Schematic diagram

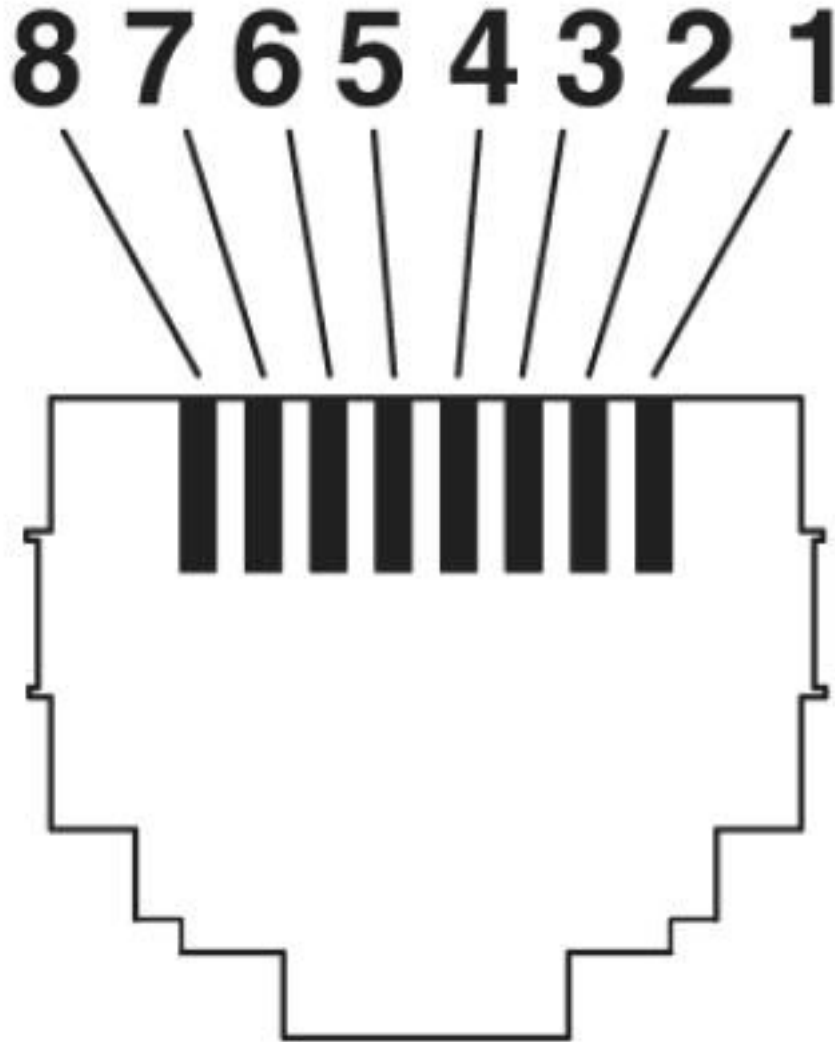

Dimensional drawing

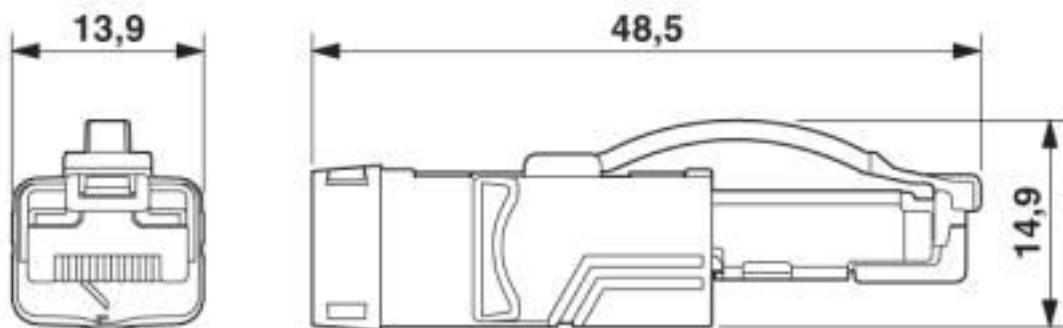

RJ45 connector, IP20

Patch cable - VS-PNRJ45-PNRJ45-93B-0,5 - 1406398

Circuit diagram

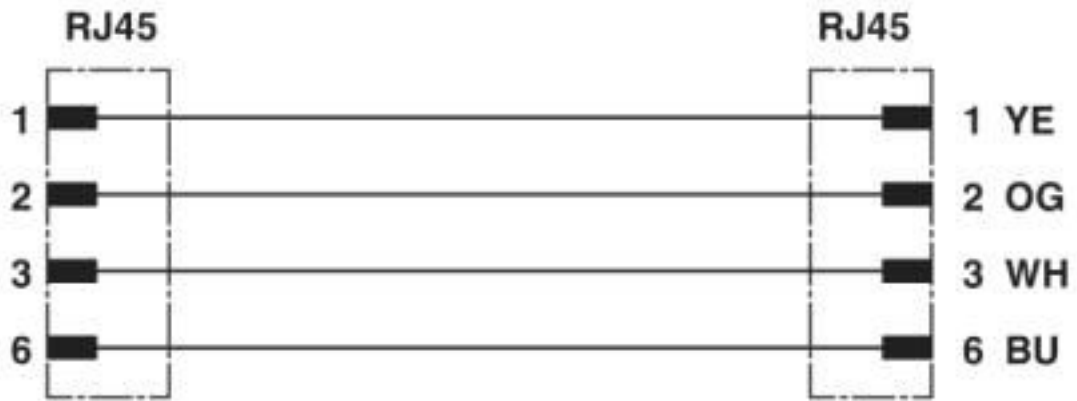

Cable cross section

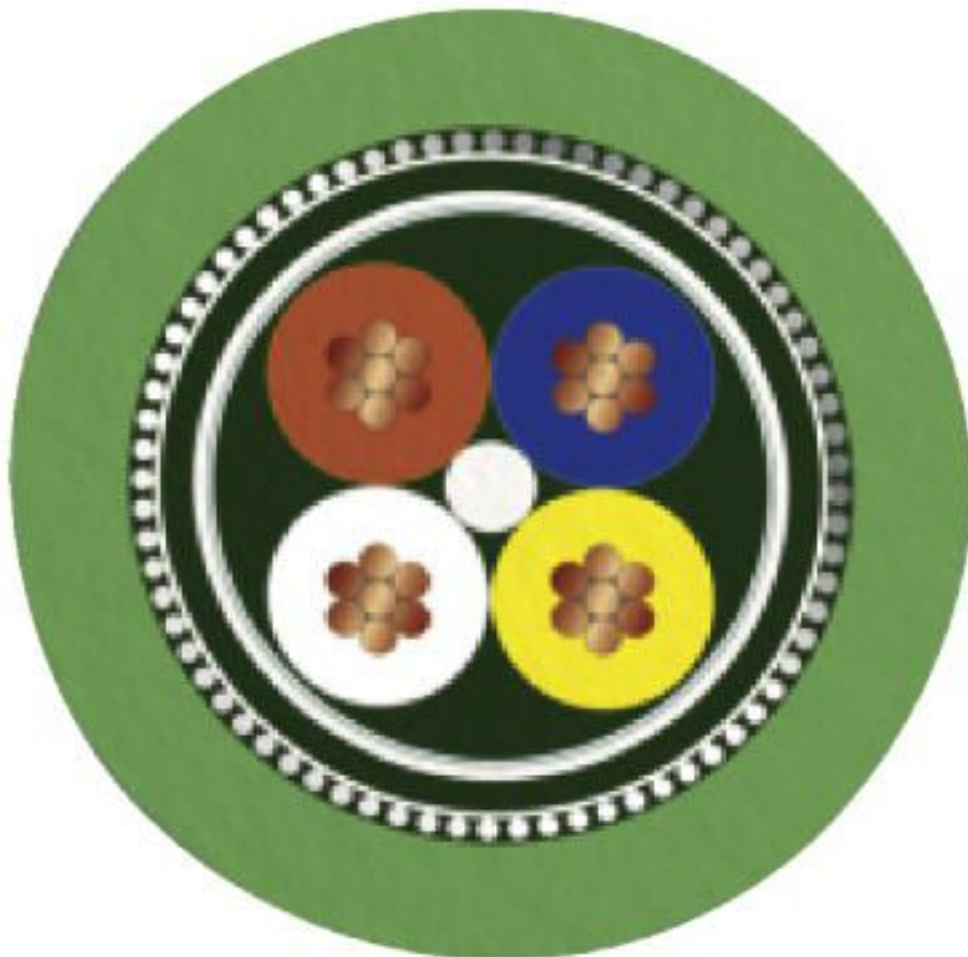

Patch cable - VS-PNRJ45-PNRJ45-93B-0,5 - 1406398

Classifications

eCl@ss

eCl@ss 10.0.1	27060308
eCl@ss 4.0	24010400
eCl@ss 4.1	24010400
eCl@ss 5.0	19030300
eCl@ss 5.1	19030300
eCl@ss 6.0	27061800
eCl@ss 7.0	27060308
eCl@ss 8.0	27060308
eCl@ss 9.0	27060308

ETIM

ETIM 3.0	EC000830
ETIM 4.0	EC000438
ETIM 5.0	EC002599
ETIM 6.0	EC001262
ETIM 7.0	EC001262

UNSPSC

UNSPSC 6.01	26121616
UNSPSC 7.0901	26121616
UNSPSC 11	26121604
UNSPSC 12.01	31261501
UNSPSC 13.2	26121604
UNSPSC 18.0	26121604
UNSPSC 19.0	26121604
UNSPSC 20.0	26121604
UNSPSC 21.0	26121604

Approvals

Approvals

Approvals

EAC

Ex Approvals

Approval details

Patch cable - VS-PNRJ45-PNRJ45-93B-0,5 - 1406398

Approvals

EAC		19060508
-----	---	----------

Phoenix Contact 2020 © - all rights reserved
<http://www.phoenixcontact.com>

PHOENIX CONTACT GmbH & Co. KG
Flachsmarktstr. 8
32825 Blomberg
Germany
Tel. +49 5235 300
Fax +49 5235 3 41200
<http://www.phoenixcontact.com>

X-ON Electronics

Largest Supplier of Electrical and Electronic Components

Click to view similar products for [Ethernet Cables / Networking Cables](#) category:

Click to view products by [Phoenix Contact](#) manufacturer:

Other Similar products are found below :

[73-6670-7](#) [73-6680-15](#) [73-7797-25](#) [MCJB2-10P6Q7-120](#) [84909-0204](#) [1200700174](#) [1200860368](#) [E16A06002M030](#) [E200102-009-S1](#)
[AX105346-EW](#) [MT14-187L](#) [17-103530](#) [ERWPAB3002M005](#) [190-038045-01](#) [NK5EPC18RDY](#) [NK5EPC18VLY](#) [NK5EPC18YLY](#)
[NK5EPC1GRY](#) [NK5EPC4Y](#) [NK5EPC6YLY](#) [NK5EPC8BLY](#) [NK5EPC9YLY](#) [1969343-6](#) [C501100010](#) [C501106002](#) [C501106007](#)
[C501106015](#) [C501106025](#) [C601102010](#) [C601104010](#) [C601106007](#) [C601106015](#) [2142758-2](#) [2168427-2](#) [CAT1106007](#) [21949-1](#) [2J1866A](#)
[RJF SFTP 5E 0500](#) [AX100351](#) [MN14CEC/ST](#) [C501100015](#) [C501106004](#) [C501106010](#) [C5F1108007](#) [C601104004](#) [C601106004](#)
[CA21106004](#) [CA21106010](#) [CA21106015](#) [CA21109007](#)