

Contact insert - HC-HS06-I-UT-F - 1406530

Please be informed that the data shown in this PDF Document is generated from our Online Catalog. Please find the complete data in the user's documentation. Our General Terms of Use for Downloads are valid (<http://phoenixcontact.com/download>)



HEAVYCON female insert, HS6 series, 6-pos., screw connection

Your advantages

- For fast coding with plastic profile



Key Commercial Data

Packing unit	1 pc
GTIN	 4 046356 921350
GTIN	4046356921350

Technical data

General

Note	For HEAVYCON housing B16 and B32
	Connectors may be operated only when there is no load/voltage.
Connection method	Screw connection
Tightening torque	1.2 Nm
Torque	0.8 Nm ... 1.2 Nm (PE connection)
	0.5 Nm ... 0.8 Nm (Mounting screws for mounting in the HEAVYCON housing)
Number of connections per position	1
Degree of pollution	3
Overvoltage category	III
Number of positions	6+PE
Insertion/withdrawal cycles	≥ 500
Size	B16
	B32
Contact numbering	1 - 6

Contact insert - HC-HS06-I-UT-F - 1406530

Technical data

General

Conductor cross section	0.5 mm ² ... 6 mm ² (power contacts)
Connection cross section AWG	20 ... 10
Stripping length of the individual wire	10 mm
Assembly instructions	To ensure correct use, installation in housing with IP54 protection or better is required

Ambient conditions

Ambient temperature (operation)	-40 °C ... 125 °C (including heating up of contacts)
---------------------------------	--

Material data

Contact material	Copper alloy
Contact surface material	Ag
Contact carrier material	PC
Standards/regulations	PC: Fire protection in rail vehicles - requirement sets R22, R23, and R24 acc. to DIN EN 45545-2 (Risk level HL1 - HL3)

Electrical characteristics

Rated voltage for power contacts	400/690 V
Rated voltage (III/3)	400 V (Conductor-PE)
	690 V (Conductor-Conductor)
Rated surge voltage	6 kV (power contacts)
Rated current	41 A (power contacts)

Standards and Regulations

Flammability rating according to UL 94	V0
Standards/regulations	acc. to DIN EN 45545-2

Environmental Product Compliance

REACH SVHC	Lead 7439-92-1
China RoHS	Environmentally Friendly Use Period = 50 years
	For details about hazardous substances go to tab "Downloads", Category "Manufacturer's declaration"

Drawings

Contact insert - HC-HS06-I-UT-F - 1406530

Diagram

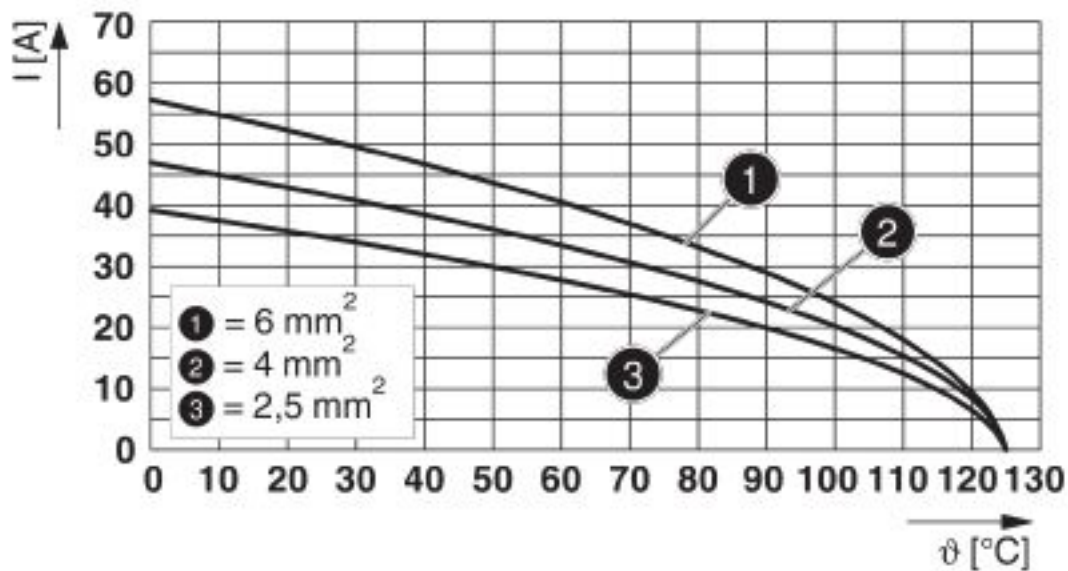

Derating diagram

Dimensional drawing

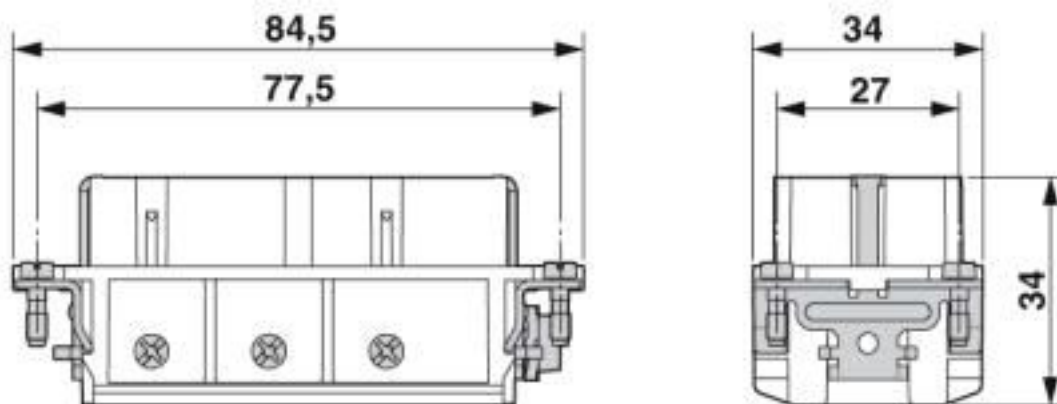

Dimensional drawing

Contact insert - HC-HS06-I-UT-F - 1406530

Dimensional drawing

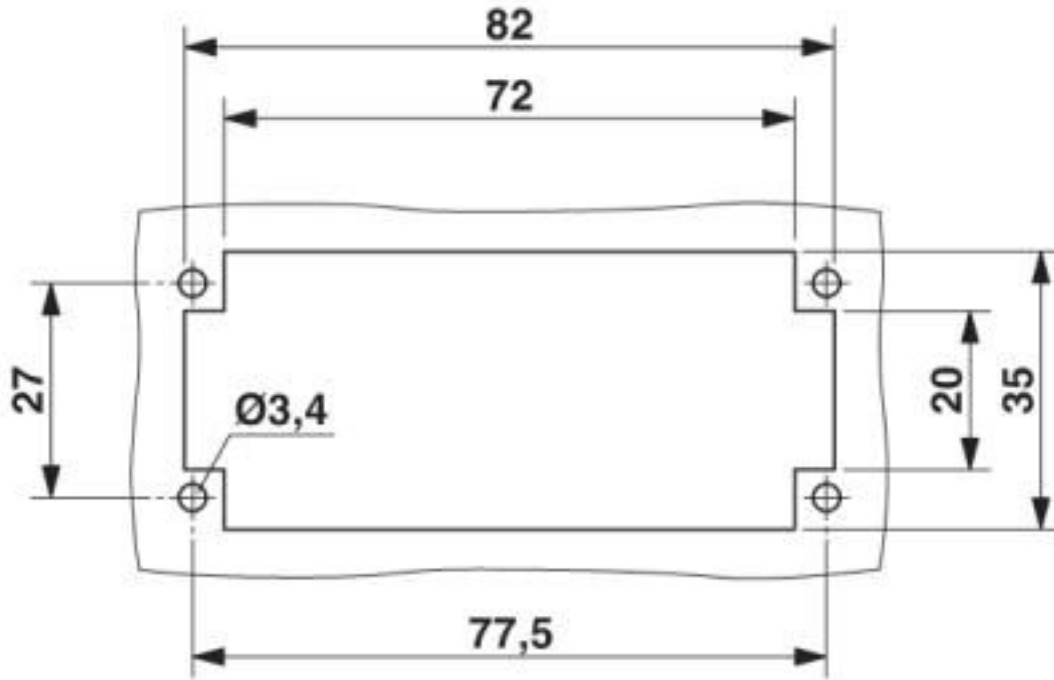

Mounting cutout when used without housing

Contact insert - HC-HS06-I-UT-F - 1406530

Schematic diagram

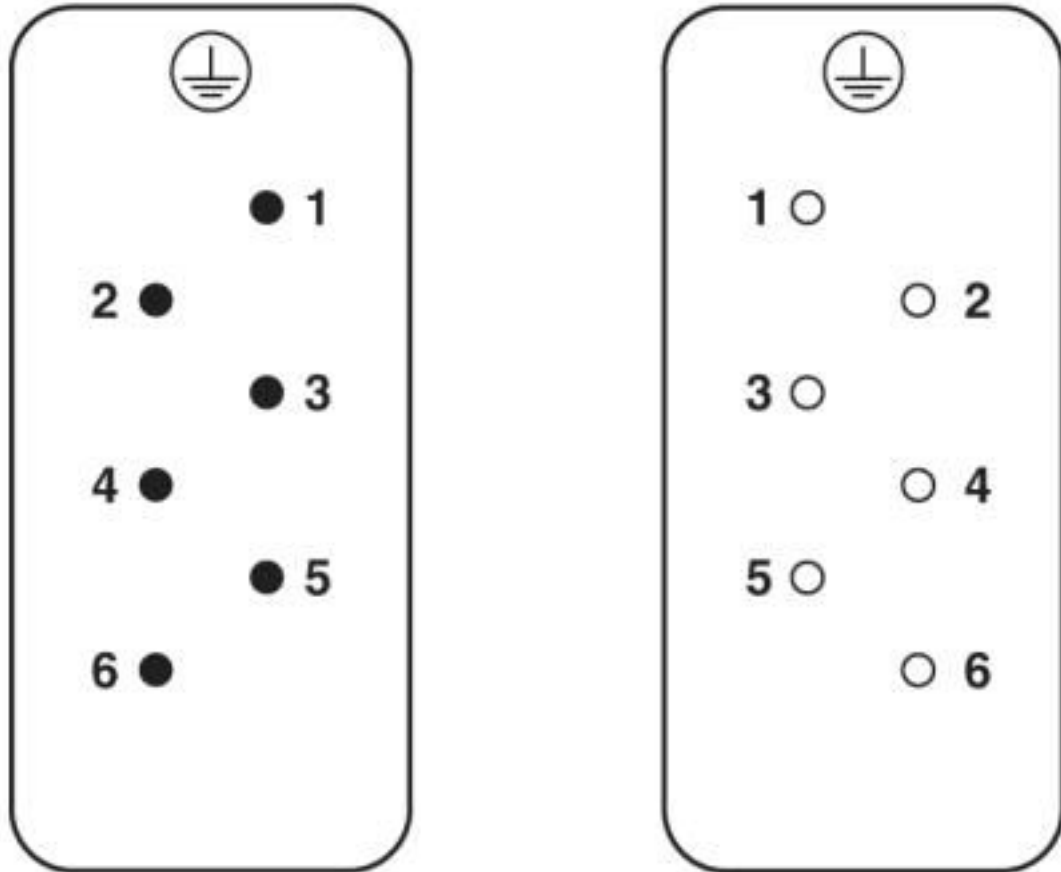

Connector pin assignment, connection side

Classifications

eCl@ss

eCl@ss 10.0.1	27440205
eCl@ss 5.1	27261200
eCl@ss 6.0	27261200
eCl@ss 7.0	27440205
eCl@ss 8.0	27440205
eCl@ss 9.0	27440205

ETIM

ETIM 4.0	EC000438
ETIM 5.0	EC000438
ETIM 6.0	EC000438
ETIM 7.0	EC000438

Contact insert - HC-HS06-I-UT-F - 1406530

Classifications

UNSPSC

UNSPSC 13.2	39121522
UNSPSC 18.0	39121522
UNSPSC 19.0	39121522
UNSPSC 20.0	39121522
UNSPSC 21.0	39121522

Approvals

Approvals

Approvals

CSA / UL Recognized / EAC / DNV GL / EAC

Ex Approvals

Approval details

CSA		http://www.csagroup.org/services-industries/product-listing/	013631_0_000
Nominal voltage UN		600 V	
Nominal current IN		32 A	
mm ² /AWG/kcmil		10	

UL Recognized		http://database.ul.com/cgi-bin/XYV/template/LISEXT/1FRAME/index.htm	FILE E 118976
Nominal voltage UN		600 V	
Nominal current IN		35 A	
mm ² /AWG/kcmil		10	

EAC			RU C- DE.AI30.B.01102
-----	---	--	--------------------------

DNV GL		https://approvalfinder.dnvgl.com/	TAE000037S
--------	---	---	------------

Contact insert - HC-HS06-I-UT-F - 1406530

Approvals

EAC



RU C-
DE.BL08.B.00511

Accessories

Accessories

Coding element

Coding element - HC-CST - 1676857



Coding peg for coding up to 16 connectors

Coding element - HC-CBU - 1676860



Coding socket for coding up to 16 connectors

Coding bolt - HC-CB - 1772722



Coding pin, prevents mismatching of up to six connectors with an identical number of positions

Coding profile - CP-HC - 1686478



Coding profile, 4 coding profiles per strip, for insertion in coding keyways

Mounting material

Contact insert - HC-HS06-I-UT-F - 1406530

Accessories

Screw - HC-HS-PES - 1586219



PE screw, for HC-HS contact inserts

Additional products

Contact insert - HC-HS06-I-UT-M - 1406531



HEAVYCON male insert, HS6 series, 6-pos., screw connection

Phoenix Contact 2020 © - all rights reserved
<http://www.phoenixcontact.com>

PHOENIX CONTACT GmbH & Co. KG
Flachsmarktstr. 8
32825 Blomberg
Germany
Tel. +49 5235 300
Fax +49 5235 3 41200
<http://www.phoenixcontact.com>

X-ON Electronics

Largest Supplier of Electrical and Electronic Components

Click to view similar products for [Heavy Duty Power Connectors](#) category:

Click to view products by [Phoenix Contact](#) manufacturer:

Other Similar products are found below :

[647757-1](#) [6643411-1](#) [6646058-2](#) [6646137-1](#) [6646138-1](#) [6646479-1](#) [6646608-1](#) [6646786-1](#) [6646940-1](#) [6651091-1](#) [6651525-1](#) [6651529-1](#)
[6651788-1](#) [696475-1](#) [702-32-01109](#) [703-25-02205](#) [73000005059](#) [73000005642](#) [73080255059](#) [73080965046](#) [765-15-0080A](#) [765-16-0080B](#)
[765-18-0080D](#) [829992-1](#) [902-77-02113](#) [PS00/A0620/6300](#) [PS25/A0420/63](#) [129-1J](#) [1409400](#) [AN0024023](#) [E6374G1](#) [e6389g2](#) [157-43GW8](#)
[MS3117-14AC](#) [1643543-1](#) [1650540-1](#) [1651811-2](#) [1766260-1](#) [1766282-1](#) [1766966-1](#) [1791340000](#) [NLDFT-3-BL-L-S120-M40A](#) [NLDFT-N-](#)
[W-L-C240-M40B](#) [NLS-2-R-C240-M40B](#) [NLS-N-W-C240-M40B](#) [NPS-3-BL-T6](#) [1986615-1](#) [2-1589900-8](#) [2199314-1](#) [KA8102](#)