

Network cable - NBC-MSD/ 1,0-93E SCO - 1407356

Please be informed that the data shown in this PDF Document is generated from our Online Catalog. Please find the complete data in the user's documentation. Our General Terms of Use for Downloads are valid (<http://phoenixcontact.com/download>)



Network cable, Ethernet CAT5 (100 Mbps), 4-position, PUR, water blue RAL 5021, shielded, Plug straight M12 SPEEDCON / IP67, coding: D, on free cable end, cable length: 1 m



Key Commercial Data

Packing unit	1 pc
GTIN	 4 046356 774840
GTIN	4046356774840

Technical data

Dimensions

Length of cable	1 m
-----------------	-----

Ambient conditions

Degree of protection	IP65
	IP67
Ambient temperature (operation)	-25 °C ... 90 °C (M12 connector)

General data

Note	Further products with variable cable type and variable cable length can be found in the accessories section
Rated current at 40°C	4 A (Plug/socket in accordance with IEC 61076-2-101, cable technical data is to be observed)
Rated voltage	48 V AC
	60 V DC
Number of positions	4
Signal type/category	Ethernet CAT5 (IEC 11801), 100 Mbps
Standards/regulations	M12 connector IEC 61076-2-101
Contact material	CuSn
Contact carrier material	TPU GF

Network cable - NBC-MSD/ 1,0-93E SCO - 1407356

Technical data

General data

Contact surface material	Ni/Au
Degree of protection	IP65/IP67
Transmission characteristics (category)	CAT5

Characteristics head 1

Head type	Plug straight M12 SPEEDCON / IP67
No. of positions (pin connector pattern)	4
Coding	D (Data)
Color	black
Material (component)	CuZn (Contact)
	Ni/Au (Contact surface)
	PA (Contact carriers)
	TPU, hardly inflammable, self-extinguishing (Grip)
	Zinc die-cast, nickel-plated (Screw connection)
Insulation resistance	≥ 100 MΩ
Insertion/withdrawal cycles	≥ 100
Torque	0.4 Nm
Ambient temperature (operation)	-25 °C ... 90 °C
Shielded	yes
Outer sheath, material	PUR
External sheath, color	water blue RAL 5021
Type type, plug side	Plug straight
Type type, socket side	free cable end

Characteristics head 2

Head type	free cable end
Color	black

Standards and Regulations

Standards/specifications	M12 connector IEC 61076-2-101
--------------------------	-------------------------------

Cable

Cable type	Ethernet flexible CAT5, 2-pair
Cable type (abbreviation)	93E
UL AWM style	20963 (80°C/30 V)
Signal type/category	Ethernet CAT5 (IEC 11801), 100 Mbps
Cable structure	2x2xAWG26/7; SF/UTP
Conductor cross section	2x 2x 0.14 mm ²
AWG signal line	26
Conductor structure signal line	7x 0.16 mm
Core diameter including insulation	0.98 mm
Wire colors	white/orange-orange, white/green-green
Twisted pairs	2 cores to the pair

Network cable - NBC-MSD/ 1,0-93E SCO - 1407356

Technical data

Cable

Overall twist	Two pairs with two fillers to the core
Shielding	Aluminum-coated foil, tinned copper braided shield
Optical shield covering	70 %
External sheath, color	water blue RAL 5021
Outer sheath thickness	1.2 mm
External cable diameter D	6.4 mm ±0.2 mm
Minimum bending radius, fixed installation	4 x D
Minimum bending radius, flexible installation	8 x D
Tensile strength GRP	≤ 80 N
Cable weight	42 kg/km
Outer sheath, material	PUR
Material conductor insulation	Foamed PE
Conductor material	Bare Cu litz wires
Standards/specifications	Electrical requirements EN 50288-2-2
Insulation resistance	≥ 500 MΩ*km
Loop resistance	≤ 290.00 Ω/km
Cable capacity	approx. 45 nF/km (at 1 kHz)
Wave impedance	100 Ω ±5 Ω (at 100 MHz)
Near end crosstalk attenuation (NEXT)	65.3 dB (with 1 MHz)
	56.3 dB (at 4 MHz)
	50.3 dB (at 10 MHz)
	47.2 dB (at 16 MHz)
	45.8 dB (at 20 MHz)
	42.9 dB (at 31.25 MHz)
	38.4 dB (at 62.5 MHz)
	35.3 dB (at 100 MHz)
Power-summated near end crosstalk attenuation (PSNEXT)	62.3 dB (with 1 MHz)
	53.3 dB (at 4 MHz)
	47.3 dB (at 10 MHz)
	44.2 dB (at 16 MHz)
	42.8 dB (at 20 MHz)
	39.9 dB (at 31.25 MHz)
	35.4 dB (at 62.5 MHz)
	32.3 dB (at 100 MHz)
Attenuation	3.2 dB (with 1 MHz)
	6 dB (at 4 MHz)
	9.5 dB (at 10 MHz)
	12.1 dB (at 16 MHz)
	13.6 dB (at 20 MHz)
	17.1 dB (at 31.25 MHz)

Network cable - NBC-MSD/ 1,0-93E SCO - 1407356

Technical data

Cable

	24.8 dB (at 62.5 MHz)
	32 dB (at 100 MHz)
Return loss (RL)	23 dB (at 4 MHz)
	24.1 dB (at 8 MHz)
	25 dB (at 10 MHz)
	25 dB (at 16 MHz)
	25 dB (at 20 MHz)
	23.6 dB (at 31.25 MHz)
	21.5 dB (at 62.5 MHz)
	20.1 dB (at 100 MHz)
Signal runtime	5.3 ns/m
Coupling resistance	≤ 100.00 mΩ/m (at 10 MHz)
Nominal voltage, cable	≤ 100 V (Peak value, not for high-power applications)
Test voltage Core/Core	700 V (50 Hz, 1 min.)
Test voltage Core/Shield	700 V (50 Hz, 1 min.)
Current carrying capacity of cable	2 A (according to DIN VDE 0891-1)
Flame resistance	according to IEC 60332-1-2
	in acc. to UL VW1
Halogen-free	according to IEC 60754-1
Resistance to oil	according to EN 60811-2-1
Ambient temperature (operation)	-40 °C ... 80 °C (cable, fixed installation)
	-20 °C ... 80 °C (cable, flexible installation)
Ambient temperature (installation)	-20 °C ... 80 °C
Ambient temperature (storage/transport)	-20 °C ... 80 °C

Environmental Product Compliance

REACH SVHC	Lead 7439-92-1
China RoHS	Environmentally Friendly Use Period = 50 years
	For details about hazardous substances go to tab "Downloads", Category "Manufacturer's declaration"

Drawings

Network cable - NBC-MSD/ 1,0-93E SCO - 1407356

Dimensional drawing

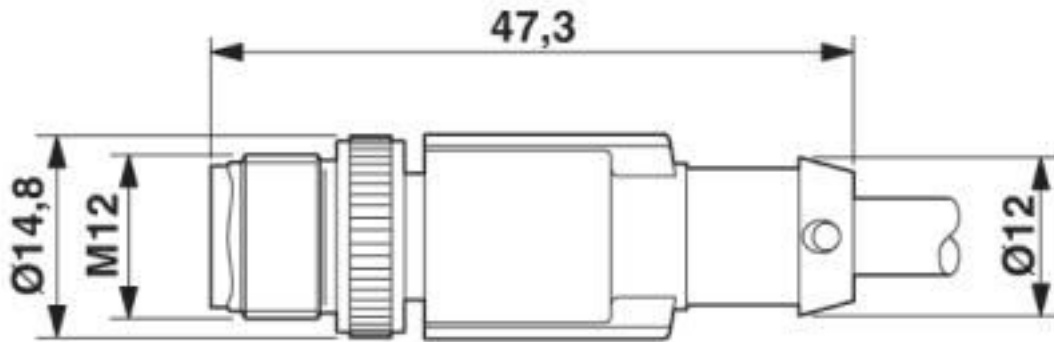

Plug, M12 x 1, straight, shielded

Circuit diagram

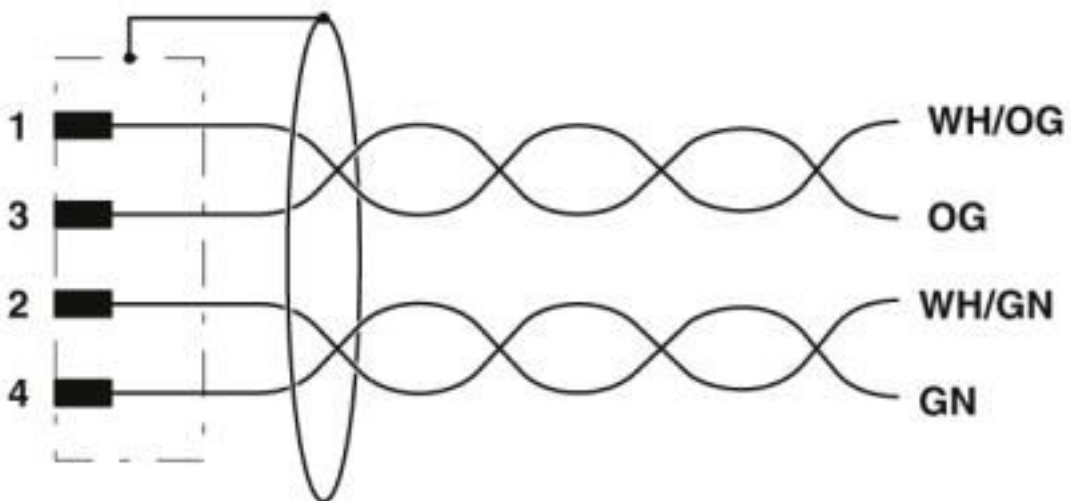

Contact assignment of the M12 plug

Network cable - NBC-MSD/ 1,0-93E SCO - 1407356

Schematic diagram

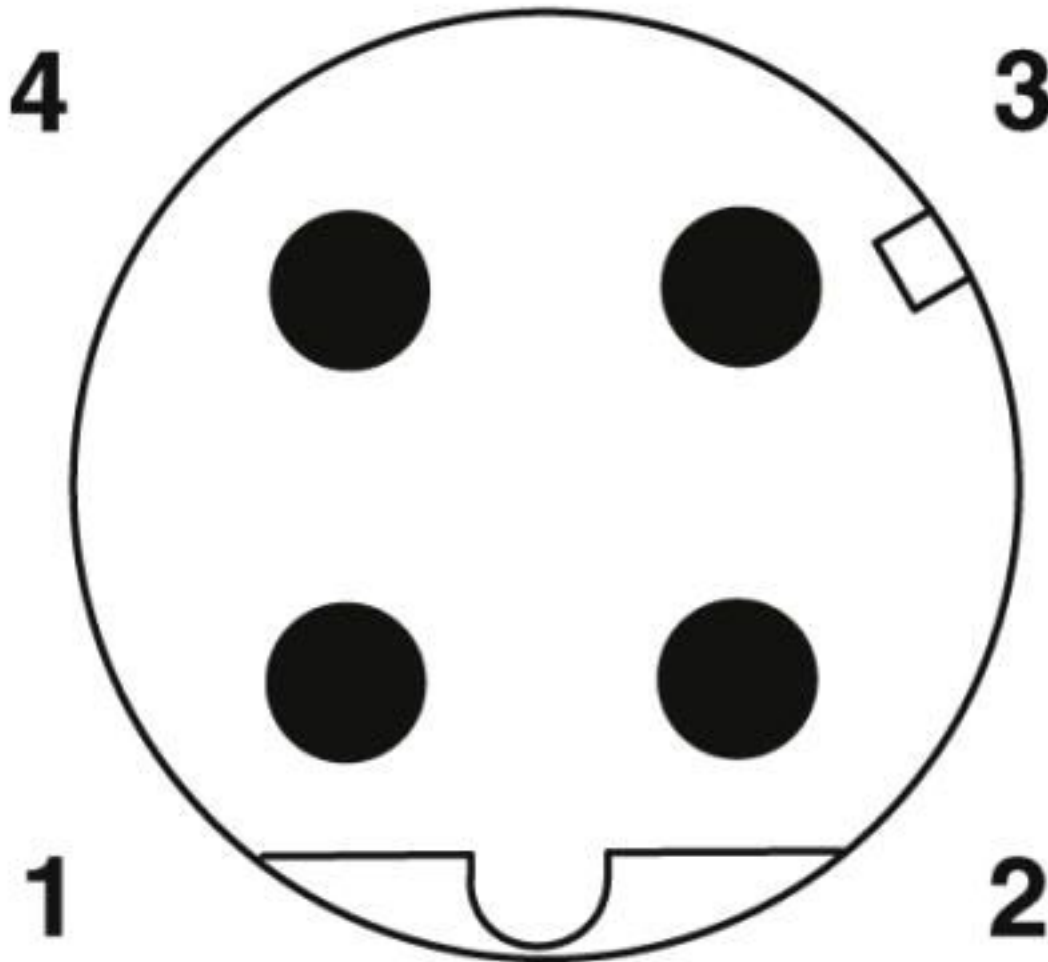

Pin assignment M12 male connector, 4-pos., D-coded, male side

Network cable - NBC-MSD/ 1,0-93E SCO - 1407356

Cable cross section

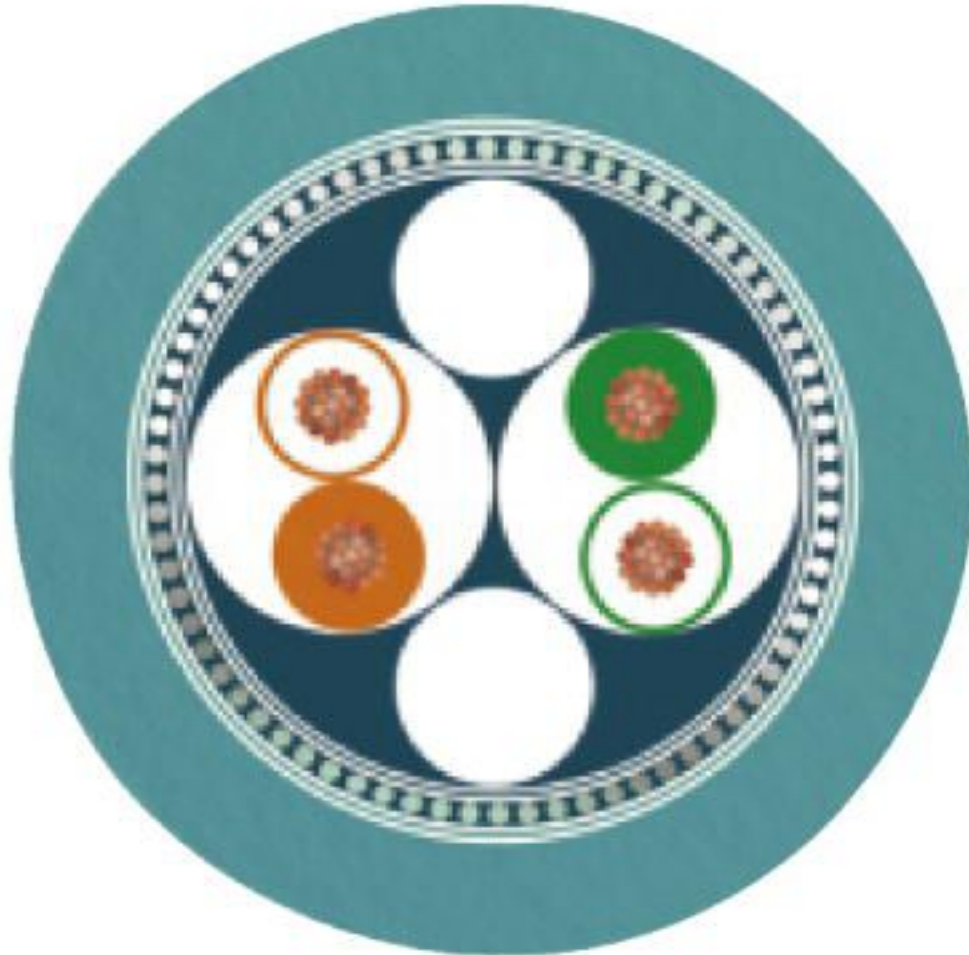

Ethernet flexible CAT5, 2-pair [93E]

Classifications

eCl@ss

eCl@ss 10.0.1	27060308
eCl@ss 4.0	24010400
eCl@ss 4.1	24010400
eCl@ss 5.0	19030300
eCl@ss 5.1	19030300
eCl@ss 6.0	27061800
eCl@ss 7.0	27061801
eCl@ss 8.0	27061801
eCl@ss 9.0	27060308

Network cable - NBC-MSD/ 1,0-93E SCO - 1407356

Classifications

ETIM

ETIM 3.0	EC001855
ETIM 4.0	EC001855
ETIM 5.0	EC002599
ETIM 6.0	EC001262
ETIM 7.0	EC001262

UNSPSC

UNSPSC 6.01	31251501
UNSPSC 7.0901	31251501
UNSPSC 11	31251501
UNSPSC 12.01	31251501
UNSPSC 13.2	31251501
UNSPSC 18.0	26121604
UNSPSC 19.0	26121604
UNSPSC 20.0	26121604
UNSPSC 21.0	26121604

Approvals

Approvals

Approvals

UL Recognized / cUL Recognized / EAC-RoHS / cULus Recognized

Ex Approvals

Approval details

UL Recognized		http://database.ul.com/cgi-bin/XYV/template/LISEXT/1FRAME/index.htm	FILE E 335024
Nominal voltage UN	30 V		
Nominal current IN	4 A		

cUL Recognized		http://database.ul.com/cgi-bin/XYV/template/LISEXT/1FRAME/index.htm	FILE E 335024
Nominal voltage UN	30 V		

Network cable - NBC-MSD/ 1,0-93E SCO - 1407356

Approvals

Nominal current I _N	4 A
--------------------------------	-----

EAC-RoHS		RU D- DE.HB35.B.00387
----------	--	--------------------------

cULus Recognized	
------------------	--

Accessories

Accessories

Cable connector

Conductor connectors - SACC-CC-4QO SH ETH - 1414415



Cable connector, Ethernet CAT5 (100 Mbps), 4-pos., halogen-free, shielded, insulation displacement connection, housing material: zinc die-cast, nickel-plated, outer cable diameter of 5 mm ... 9.7 mm

Circular connector (cable-side)

Data connector - SACC-MSD-4QO SH ETH SCO - 1411066



Data connector, Ethernet CAT5 (100 Mbps), 4-position, halogen-free, shielded, Plug straight M12 SPEEDCON, Coding: D, Insulation displacement connection, knurl material: Zinc die-cast, nickel-plated, external cable diameter 5 mm ... 9.7 mm

Data connector - SACC-M12MRD-4Q SH - 1553624



Data connector, Ethernet CAT5 (100 Mbps), 4-position, shielded, Plug angled M12, Coding: D, Insulation displacement connection, knurl material: Nickel-plated brass, external cable diameter 4 mm ... 8 mm

Network cable - NBC-MSD/ 1,0-93E SCO - 1407356

Accessories

Data connector - SACC-FSD-4QO SH ETH SCO - 1411069



Data connector, Ethernet CAT5 (100 Mbps), 4-position, halogen-free, shielded, Socket straight M12 SPEEDCON, Coding: D, Insulation displacement connection, knurl material: Zinc die-cast, nickel-plated, external cable diameter 5 mm ... 9.7 mm

Data connector - SACC-M12FRD-4Q SH - 1553637



Data connector, Ethernet CAT5 (100 Mbps), 4-position, shielded, Socket angled M12, Coding: D, Insulation displacement connection, knurl material: Nickel-plated brass, external cable diameter 4 mm ... 8 mm

Corrugated pipe

Protective hose - WP-PA HF 13,0 BK - 3240681



Polyamide protective hose, inflammability class V0, UV resistant

Protective hose - WP-PA HF-HB 13,0 BK - 3240839



Polyamide protective hose, inflammability class HB, UV resistant

Cutting tools

Cable-cutting tool - CUTFOX 12 - 1212128



Cable cutter, for copper and aluminum up to 12 mm diameter (up to 35 mm²)

Network cable - NBC-MSD/ 1,0-93E SCO - 1407356

Accessories

Diagonal cutter - CUTFOX-S VDE - 1212207



Diagonal cutter for hard (piano wire) and soft wires, VDE 1000 V AC/1500 V DC tested

Data cable preassembled

Network cable - NBC-MSD SCO/.../... - 1408713



Network cable, Ethernet CAT5 (100 Mbps), 4-position, shielded, Plug straight M12 SPEEDCON / IP67, coding: D, on free cable end, cable length: Free input (0.2 ... 40.0 m)

Network cable - NBC-MRD SCO/.../... - 1408705



Network cable, Ethernet CAT5 (100 Mbps), 4-position, shielded, Plug angled M12 SPEEDCON / IP67, coding: D, on free cable end, cable length: Free input (0.2 ... 40.0 m)

Network cable - NBC-FSD SCO/.../... - 1408697



Network cable, Ethernet CAT5 (100 Mbps), 4-position, shielded, free cable end, on Socket straight M12 SPEEDCON / IP67, coding: D, cable length: Free input (0.2 ... 40.0 m)

Network cable - NBC-FRD SCO/.../... - 1408690



Network cable, Ethernet CAT5 (100 Mbps), 4-position, shielded, free cable end, on Socket angled M12 SPEEDCON / IP67, coding: D, cable length: Free input (0.2 ... 40.0 m)

Data plug

Network cable - NBC-MSD/ 1,0-93E SCO - 1407356

Accessories

RJ45 connector - VS-08-RJ45-5-Q/IP20 - 1656725



RJ45 connector, degree of protection: IP20, number of positions: 8, 1 Gbps, CAT5 (IEC 11801:2002), material: PA, connection method: IDC fast connection, connection cross section: AWG 26- 23, cable outlet: straight, color: traffic grey A RAL 7042

RJ45 connector - VS-08-RJ45-5-Q/IP20 BK - 1658008



RJ45 connector, degree of protection: IP20, number of positions: 8, 1 Gbps, CAT5 (IEC 11801:2002), material: PA, connection method: IDC fast connection, connection cross section: AWG 26- 23, cable outlet: straight, color: black

RJ45 connector - CUC-IND-C1ZNI-S/R4IE8 - 1421607



RJ45 connector, degree of protection: IP20, number of positions: 8, 1 Gbps, CAT5 (IEC 11801:2002), material: Zinc die-cast, connection method: IDC fast connection, connection cross section: AWG 26- 24, cable outlet: straight, color: green

RJ45 connector - CUC-IND-C1ZNI-T/R4IE8 - 1421877



RJ45 connector, degree of protection: IP20, number of positions: 8, 1 Gbps, CAT5 (IEC 11801:2002), material: Zinc die-cast, connection method: IDC fast connection, connection cross section: AWG 26- 24, cable outlet: angled

RJ45 connector - CUC-IND-C1ZNI-B/R4IE8 - 1421876



RJ45 connector, degree of protection: IP20, number of positions: 8, 1 Gbps, CAT5 (IEC 11801:2002), material: Zinc die-cast, connection method: IDC fast connection, connection cross section: AWG 26- 24, cable outlet: angled

Network cable - NBC-MSD/ 1,0-93E SCO - 1407356

Accessories

RJ45 connector - CUC-V06-C1PGY-S/R4CE8:1 - 1414383



RJ45 connector, degree of protection: IP67, number of positions: 8, 1 Gbps, CAT6, material: PA, connection method: Crimp connection, connection cross section: AWG 27- 24, cable outlet: straight, color: gray

RJ45 connector - CUC-V06-C1PBK-S/R4CE8:1 - 1414408



RJ45 connector, degree of protection: IP67, number of positions: 8, 1 Gbps, CAT6, material: PA, connection method: Crimp connection, connection cross section: AWG 24- 27, cable outlet: straight, color: black

RJ45 connector - CUC-V14-C1ZNI-S/R4E8 - 1422661



Push-pull connector (version 14), die-cast zinc, with RJ45 connector insert, 8-pos., with IDC fast connection technology, for 1 and 7-wire cores, 26 ... 24 AWG, for cable diameter of 5.5 mm ... 10 mm

RJ45 connector - CUC-V14-C1ZNI-T/R4E8 - 1422663



Push-pull connector (version 14), die-cast zinc, with RJ45 connector insert, 8-pos., with IDC fast connection technology, for 1 and 7-wire cores, 26 ... 24 AWG, for cable diameter of 5.5 mm ... 10 mm

RJ45 connector - CUC-V14-C1ZNI-B/R4E8 - 1422662



Push-pull connector (version 14), die-cast zinc, with RJ45 connector insert, 8-pos., with IDC fast connection technology, for 1 and 7-wire cores, 26 ... 24 AWG, for cable diameter of 5.5 mm ... 10 mm

Network cable - NBC-MSD/ 1,0-93E SCO - 1407356

Accessories

RJ45 connector - VS-PPC-C1-RJ45-POBK-PG9-4Q5 - 1608126



RJ45 connector, IP67, with push-pull interlocking, plastic housing, CAT5e, 4-pos., with QUICKON fast connection technology, for 1-wire and 7-wire conductors AWG 26 ... 22, for cable cross section 5.0 mm ... 8.0 mm

Electronics pliers

Diagonal cutter - MICROFOX-SP-1 - 1212487



Electronic diagonal cutter, tapered head, without chamfer, with opening spring, non-reflective phosphate-treated surface, punched version

Protective cap

Sealing cap - PROT-M12 FS-PA-CHAIN - 1430873

M12 sealing cap made of plastic with fixing band, for sensor cables, for free M12 plugs



Safety locking

Locking clip - SAC-M12-EXCLIP-M - 1558988



Locking clip for the pin side of sensor/actuator cables with M12 connector and M12 connectors for assembly, for knurl diameter: 15 mm or for Allen key with a wrench size of 14 mm, prevents the disconnection of plug-in connections without tools

Screwdriver tools

Adapter insert - TSD-M SAC-BIT ADAPTER - 1212600



Adapter bit for TSD-M...torque tools, E6.3-1/4" drive with 4 mm hexagon to accommodate SAC bits

Network cable - NBC-MSD/ 1,0-93E SCO - 1407356

Accessories

Tool - SAC BIT M12-D15 - 1208432



Nut for assembling sensor/actuator cables with M12 connector and M12 connectors for assembly, with a knurl diameter of 15 mm, for 4 mm hexagonal drive

Stripping tool

Stripping tool - WIREFOX 4 - 1212156



Stripping tool, for cables and conductors (especially for rubber and silicone insulations) from 0.1 - 4 mm², self-adjusting, stripping length of up to 18 mm, cutting capacity of up to 10 mm² stranded/1.5 mm² solid, replaceable stripping blade

Stripping tool - WIREFOX-E 4 - 1212704



Stripping tool, for cables and conductors (especially for rubber and silicone insulations) from 0.1 - 4 mm², self-adjusting, stripping length of up to 18 mm, cutting capacity of up to 10 mm² stranded/1.5 mm² solid, replaceable stripping blade

Stripping tool - WIREFOX 10 - 1212150



Stripping tool, for cables and conductors from 0.02 - 10 mm², self-adjusting, stripping length of up to 18 mm, cutting capacity of up to 10 mm² stranded/1.5 mm² solid, replaceable stripping blade

Torque tool

Torque screwdriver - TSD 04 SAC - 1208429



Torque screwdriver, with preset torque of 0.4 Nm and 4 mm hexagonal drive for M12 connectors

Network cable - NBC-MSD/ 1,0-93E SCO - 1407356

Accessories

Torque screwdriver - TSD-M 1,2NM - 1212224



Torque screw driver, accuracy as per EN ISO 6789 standard, adjustable from 0.3 - 1.2 Nm

Stripping tool - VS-CABLE-STRIP-VARIO - 1657407



Stripping tool, for the multi-level stripping of shielded cables

Protective hose adapter - WP-CTA POM 13,0 BK - 1422884



Protective hose adapter, for corrugated hoses with a nominal size of 13 (10 x 13), corrugated in parallel

Phoenix Contact 2020 © - all rights reserved
<http://www.phoenixcontact.com>

PHOENIX CONTACT GmbH & Co. KG
Flachsmarktstr. 8
32825 Blomberg
Germany
Tel. +49 5235 300
Fax +49 5235 3 41200
<http://www.phoenixcontact.com>

X-ON Electronics

Largest Supplier of Electrical and Electronic Components

Click to view similar products for [Ethernet Cables / Networking Cables](#) category:

Click to view products by [Phoenix Contact](#) manufacturer:

Other Similar products are found below :

[73-6670-7](#) [73-6680-15](#) [73-7797-25](#) [MCJB2-10P6Q7-120](#) [84909-0204](#) [1200700174](#) [1200860368](#) [E16A06002M030](#) [E200102-009-S1](#)
[AX105346-EW](#) [MT14-187L](#) [17-103530](#) [ERWPAB3002M005](#) [190-038045-01](#) [NK5EPC18RDY](#) [NK5EPC18VLY](#) [NK5EPC18YLY](#)
[NK5EPC1GRY](#) [NK5EPC4Y](#) [NK5EPC6YLY](#) [NK5EPC8BLY](#) [NK5EPC9YLY](#) [1969343-6](#) [C501100010](#) [C501106002](#) [C501106007](#)
[C501106015](#) [C501106025](#) [C601102010](#) [C601104010](#) [C601106007](#) [C601106015](#) [2142758-2](#) [2168427-2](#) [CAT1106007](#) [21949-1](#) [2J1866A](#)
[RJF SFTP 5E 0500](#) [AX100351](#) [MN14CEC/ST](#) [C501100015](#) [C501106004](#) [C501106010](#) [C5F1108007](#) [C601104004](#) [C601106004](#)
[CA21106004](#) [CA21106010](#) [CA21106015](#) [CA21109007](#)