

## Network cable - NBC-FSD/10,0-93E/R4AC SCO - 1407387

Please be informed that the data shown in this PDF Document is generated from our Online Catalog. Please find the complete data in the user's documentation. Our General Terms of Use for Downloads are valid (<http://phoenixcontact.com/download>)



Network cable, Ethernet CAT5 (100 Mbps), 4-position, PUR, water blue RAL 5021, shielded, Plug straight RJ45 / IP20, on Socket straight M12 SPEEDCON / IP67, coding: D, cable length: 10 m



### Key Commercial Data

Packing unit	1 pc
GTIN	 4 046356 775151
GTIN	4046356775151

### Technical data

#### Dimensions

Length of cable	10 m
-----------------	------

#### Ambient conditions

Degree of protection	IP65 (M12 connector)
	IP67 (M12 connector)
	IP20 (RJ45 connector)
Ambient temperature (operation)	-25 °C ... 85 °C (M12 connector)
	-25 °C ... 60 °C (RJ45 connector)

#### General data

Note	Further products with variable cable type and variable cable length can be found in the accessories section
Rated current at 40°C	1 A
Rated voltage	48 V AC
	60 V DC
Number of positions	4
Signal type/category	Ethernet CAT5 (IEC 11801), 100 Mbps
Standards/regulations	M12 connector IEC 61076-2-101
Contact material	CuSn

# Network cable - NBC-FSD/10,0-93E/R4AC SCO - 1407387

## Technical data

### General data

Contact carrier material	TPU GF
Contact surface material	Ni/Au
Housing material	Plastic
Degree of protection	IP67/IP20
Transmission characteristics (category)	CAT5

### Characteristics head 1

Head type	Plug straight RJ45 / IP20
No. of positions (pin connector pattern)	4 (8)
Color	gray
Material (component)	CuSn (Contact)
	Ni/Au (Contact surface)
	PC (Contact carriers)
	PA (Housing)
Insertion/withdrawal cycles	≥ 750
Ambient temperature (operation)	-25 °C ... 60 °C
Shielded	yes
Outer sheath, material	PUR
External sheath, color	water blue RAL 5021
Type type, plug side	Plug straight
Type type, socket side	Socket, straight

### Characteristics head 2

Head type	Socket straight M12 SPEEDCON / IP67
No. of positions (pin connector pattern)	4
Coding	D (Data)
Color	black
	gray / black
Material (component)	CuZn (Contact)
	Ni/Au (Contact surface)
	TPU GF (Contact carriers)
	TPU, hardly inflammable, self-extinguishing (Grip)
	Zinc die-cast, nickel-plated (Screw connection)
Insulation resistance	≥ 100 MΩ
Insertion/withdrawal cycles	≥ 100
Torque	0.4 Nm
Ambient temperature (operation)	-25 °C ... 90 °C

### Standards and Regulations

Standards/specifications	M12 connector IEC 61076-2-101
--------------------------	-------------------------------

### Cable

Cable type	Ethernet flexible CAT5, 2-pair
------------	--------------------------------

# Network cable - NBC-FSD/10,0-93E/R4AC SCO - 1407387

## Technical data

### Cable

Cable type (abbreviation)	93E
UL AWM style	20963 (80°C/30 V)
Signal type/category	Ethernet CAT5 (IEC 11801), 100 Mbps
Cable structure	2x2xAWG26/7; SF/UTP
Conductor cross section	2x 2x 0.14 mm <sup>2</sup>
AWG signal line	26
Conductor structure signal line	7x 0.16 mm
Core diameter including insulation	0.98 mm
Wire colors	white/orange-orange, white/green-green
Twisted pairs	2 cores to the pair
Overall twist	Two pairs with two fillers to the core
Shielding	Aluminum-coated foil, tinned copper braided shield
Optical shield covering	70 %
External sheath, color	water blue RAL 5021
Outer sheath thickness	1.2 mm
External cable diameter D	6.4 mm ±0.2 mm
Minimum bending radius, fixed installation	4 x D
Minimum bending radius, flexible installation	8 x D
Tensile strength GRP	≤ 80 N
Cable weight	42 kg/km
Outer sheath, material	PUR
Material conductor insulation	Foamed PE
Conductor material	Bare Cu litz wires
Standards/specifications	Electrical requirements EN 50288-2-2
Insulation resistance	≥ 500 MΩ*km
Loop resistance	≤ 290.00 Ω/km
Cable capacity	approx. 45 nF/km (at 1 kHz)
Wave impedance	100 Ω ±5 Ω (at 100 MHz)
Near end crosstalk attenuation (NEXT)	65.3 dB (with 1 MHz)
	56.3 dB (at 4 MHz)
	50.3 dB (at 10 MHz)
	47.2 dB (at 16 MHz)
	45.8 dB (at 20 MHz)
	42.9 dB (at 31.25 MHz)
	38.4 dB (at 62.5 MHz)
	35.3 dB (at 100 MHz)
Power-summated near end crosstalk attenuation (PSNEXT)	62.3 dB (with 1 MHz)
	53.3 dB (at 4 MHz)
	47.3 dB (at 10 MHz)
	44.2 dB (at 16 MHz)

## Network cable - NBC-FSD/10,0-93E/R4AC SCO - 1407387

### Technical data

#### Cable

	42.8 dB (at 20 MHz)
	39.9 dB (at 31.25 MHz)
	35.4 dB (at 62.5 MHz)
	32.3 dB (at 100 MHz)
Attenuation	3.2 dB (with 1 MHz)
	6 dB (at 4 MHz)
	9.5 dB (at 10 MHz)
	12.1 dB (at 16 MHz)
	13.6 dB (at 20 MHz)
	17.1 dB (at 31.25 MHz)
	24.8 dB (at 62.5 MHz)
	32 dB (at 100 MHz)
Return loss (RL)	23 dB (at 4 MHz)
	24.1 dB (at 8 MHz)
	25 dB (at 10 MHz)
	25 dB (at 16 MHz)
	25 dB (at 20 MHz)
	23.6 dB (at 31.25 MHz)
	21.5 dB (at 62.5 MHz)
	20.1 dB (at 100 MHz)
Signal runtime	5.3 ns/m
Coupling resistance	≤ 100.00 mΩ/m (at 10 MHz)
Nominal voltage, cable	≤ 100 V (Peak value, not for high-power applications)
Test voltage Core/Core	700 V (50 Hz, 1 min.)
Test voltage Core/Shield	700 V (50 Hz, 1 min.)
Current carrying capacity of cable	2 A (according to DIN VDE 0891-1)
Flame resistance	according to IEC 60332-1-2
	in acc. to UL VW1
Halogen-free	according to IEC 60754-1
Resistance to oil	according to EN 60811-2-1
Ambient temperature (operation)	-40 °C ... 80 °C (cable, fixed installation)
	-20 °C ... 80 °C (cable, flexible installation)
Ambient temperature (installation)	-20 °C ... 80 °C
Ambient temperature (storage/transport)	-20 °C ... 80 °C

#### Environmental Product Compliance

REACH SVHC	Lead 7439-92-1
China RoHS	Environmentally Friendly Use Period = 50 years
	For details about hazardous substances go to tab "Downloads", Category "Manufacturer's declaration"

# Network cable - NBC-FSD/10,0-93E/R4AC SCO - 1407387

## Drawings

Schematic diagram

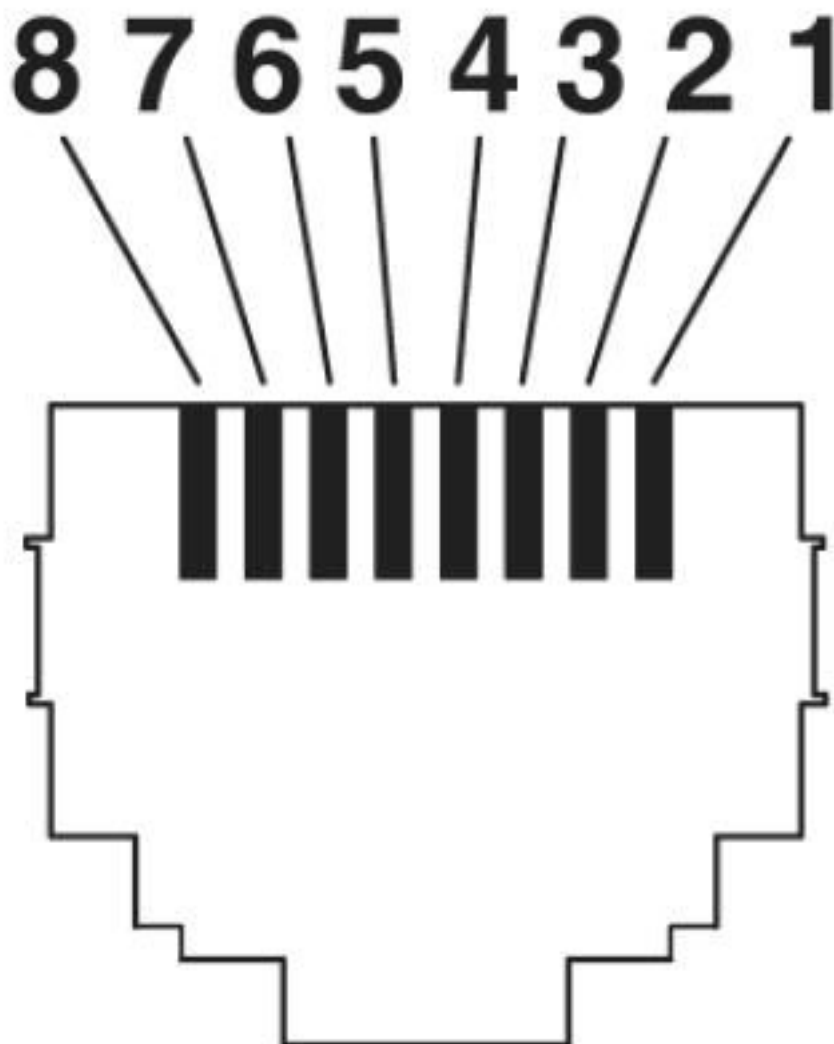

Connector pin assignment plug RJ45

# Network cable - NBC-FSD/10,0-93E/R4AC SCO - 1407387

Dimensional drawing

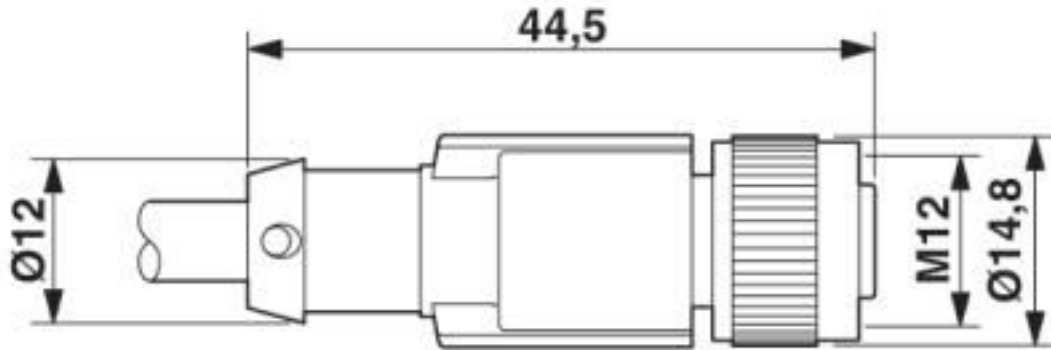

M12 x 1 socket, straight, shielded

Dimensional drawing

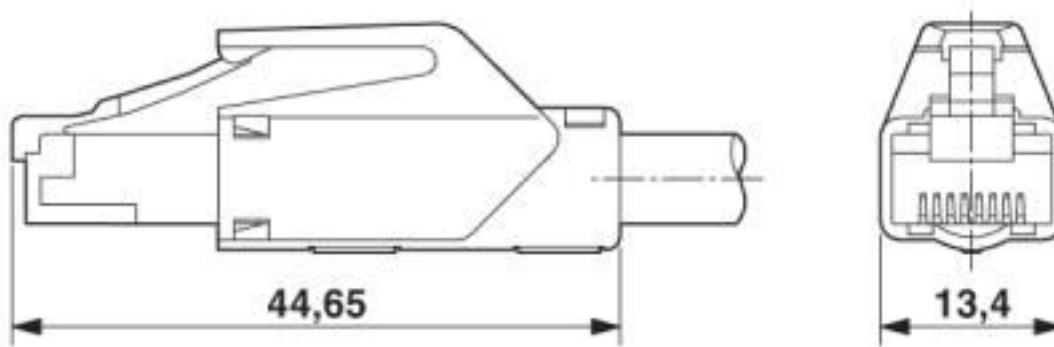

RJ45 connector, IP20

# Network cable - NBC-FSD/10,0-93E/R4AC SCO - 1407387

Circuit diagram

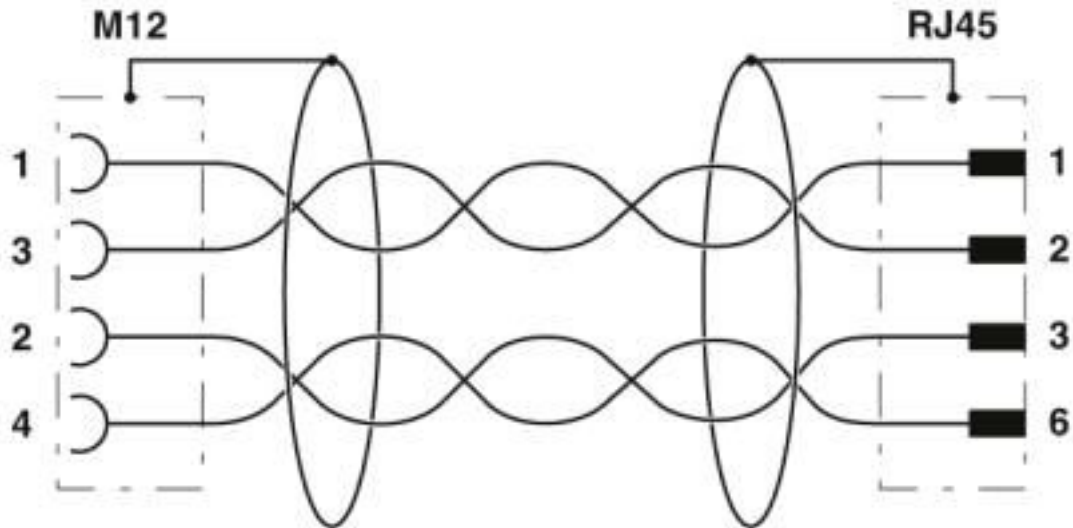

Contact assignment of the M12 socket and the RJ45 plug

## Network cable - NBC-FSD/10,0-93E/R4AC SCO - 1407387

Schematic diagram

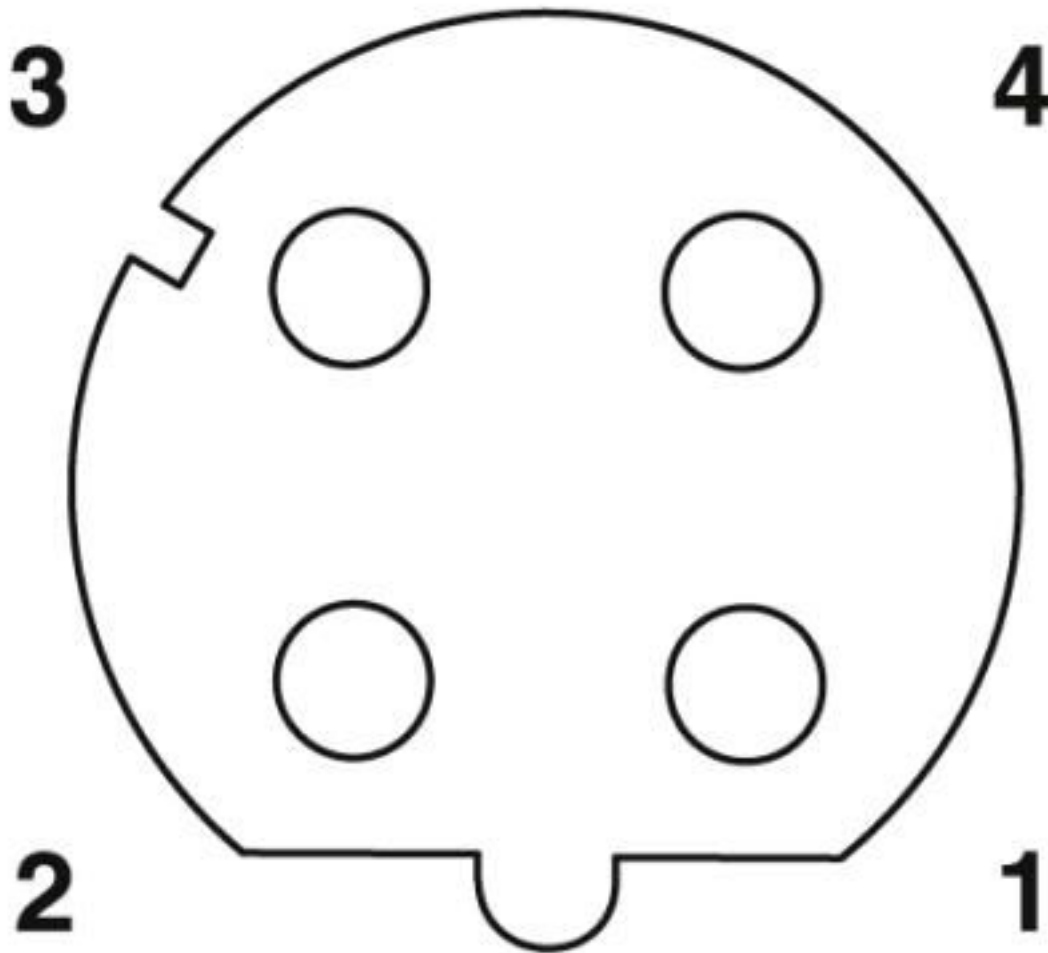

Pin assignment M12 socket, 4-pos., D-coded, female side



# Network cable - NBC-FSD/10,0-93E/R4AC SCO - 1407387

Cable cross section



Ethernet flexible CAT5, 2-pair [93E]

## Classifications

eCl@ss

eCl@ss 10.0.1	27060308
eCl@ss 4.0	24010400
eCl@ss 4.1	24010400
eCl@ss 5.0	19030300
eCl@ss 5.1	19030300
eCl@ss 6.0	27061800
eCl@ss 7.0	27061801
eCl@ss 8.0	27061801
eCl@ss 9.0	27060308

# Network cable - NBC-FSD/10,0-93E/R4AC SCO - 1407387

## Classifications

### ETIM

ETIM 3.0	EC001855
ETIM 4.0	EC001855
ETIM 5.0	EC002599
ETIM 6.0	EC001262
ETIM 7.0	EC001262

### UNSPSC

UNSPSC 6.01	31251501
UNSPSC 7.0901	31251501
UNSPSC 11	31251501
UNSPSC 12.01	31251501
UNSPSC 13.2	26121604
UNSPSC 18.0	26121604
UNSPSC 19.0	26121604
UNSPSC 20.0	26121604
UNSPSC 21.0	26121604

## Approvals

### Approvals

#### Approvals

UL Listed / cUL Listed / EAC-RoHS / cULus Listed

#### Ex Approvals

### Approval details

UL Listed		<a href="http://database.ul.com/cgi-bin/XYV/template/LISEXT/1FRAME/index.htm">http://database.ul.com/cgi-bin/XYV/template/LISEXT/1FRAME/index.htm</a>	FILE E 335024
Nominal voltage UN	30 V		
Nominal current IN	0.5 A		

cUL Listed		<a href="http://database.ul.com/cgi-bin/XYV/template/LISEXT/1FRAME/index.htm">http://database.ul.com/cgi-bin/XYV/template/LISEXT/1FRAME/index.htm</a>	FILE E 335024
Nominal voltage UN	30 V		

# Network cable - NBC-FSD/10,0-93E/R4AC SCO - 1407387

## Approvals

Nominal current IN	0.5 A
--------------------	-------

EAC-RoHS		RU D-DE.HB35.B.00387
----------	--	----------------------

cULus Listed	
--------------	--

## Accessories

### Accessories

#### Data cable preassembled

Network cable - NBC-MSD-R4AC SCO/.../... - 1408712



Network cable, Ethernet CAT5 (100 Mbps), 4-position, Variable cable type, shielded, Plug straight M12 SPEEDCON / IP67, coding: D, on Plug straight RJ45 / IP20, cable length: Free input (0.2 ... 40.0 m)

Network cable - NBC-MRD-R4AC SCO/.../... - 1408704



Network cable, Ethernet CAT5 (100 Mbps), 4-position, Variable cable type, shielded, Plug angled M12 SPEEDCON / IP67, coding: D, on Plug straight RJ45 / IP20, cable length: Free input (0.2 ... 40.0 m)

Network cable - NBC-FSD-R4AC SCO/.../... - 1408696



Network cable, Ethernet CAT5 (100 Mbps), 4-position, Variable cable type, shielded, Plug straight RJ45 / IP20, on Socket straight M12 SPEEDCON / IP67, coding: D, cable length: Free input (0.2 ... 40.0 m)

Network cable - NBC-FRD-R4AC SCO/.../... - 1408689



Network cable, Ethernet CAT5 (100 Mbps), 4-position, Variable cable type, shielded, Plug straight RJ45 / IP20, on Socket angled M12 SPEEDCON / IP67, coding: D, cable length: Free input (0.2 ... 40.0 m)

## Network cable - NBC-FSD/10,0-93E/R4AC SCO - 1407387

### Accessories

---

#### Plug for cable screw gland

Screw plug - PROT-M12 MS-PA-CHAIN - 1430899

M12 sealing cap with fixing band, for sensor cables, for free M12 sockets



#### Safety locking

Locking clip - SAC-M12-EXCLIP-F - 1558991



Locking clip for the socket side of sensor/actuator cables with M12 connector and M12 connectors for assembly, for knurl diameter: 15 mm or for Allen key with a wrench size of 14 mm, prevents the disconnection of plug-in connections without tools

#### Screwdriver tools

Adapter insert - TSD-M SAC-BIT ADAPTER - 1212600



Adapter bit for TSD-M...torque tools, E6.3-1/4" drive with 4 mm hexagon to accommodate SAC bits

Tool - SAC BIT M12-D15 - 1208432



Nut for assembling sensor/actuator cables with M12 connector and M12 connectors for assembly, with a knurl diameter of 15 mm, for 4 mm hexagonal drive

#### Torque tool

Torque screwdriver - TSD 04 SAC - 1208429



Torque screwdriver, with preset torque of 0.4 Nm and 4 mm hexagonal drive for M12 connectors

## Network cable - NBC-FSD/10,0-93E/R4AC SCO - 1407387

### Accessories

---

Torque screwdriver - TSD-M 1,2NM - 1212224



Torque screw driver, accuracy as per EN ISO 6789 standard, adjustable from 0.3 - 1.2 Nm

---

Phoenix Contact 2020 © - all rights reserved  
<http://www.phoenixcontact.com>

PHOENIX CONTACT GmbH & Co. KG  
Flachsmarktstr. 8  
32825 Blomberg  
Germany  
Tel. +49 5235 300  
Fax +49 5235 3 41200  
<http://www.phoenixcontact.com>

## X-ON Electronics

Largest Supplier of Electrical and Electronic Components

*Click to view similar products for [Ethernet Cables / Networking Cables](#) category:*

*Click to view products by [Phoenix Contact](#) manufacturer:*

Other Similar products are found below :

[73-6670-7](#) [73-6680-15](#) [73-7797-25](#) [MCJB2-10P6Q7-120](#) [84909-0204](#) [1200700174](#) [1200860368](#) [E16A06002M030](#) [E200102-009-S1](#)  
[AX105346-EW](#) [MT14-187L](#) [17-103530](#) [ERWPAB3002M005](#) [190-038045-01](#) [NK5EPC18RDY](#) [NK5EPC18VLY](#) [NK5EPC18YLY](#)  
[NK5EPC1GRY](#) [NK5EPC4Y](#) [NK5EPC6YLY](#) [NK5EPC8BLY](#) [NK5EPC9YLY](#) [1969343-6](#) [C501100010](#) [C501106002](#) [C501106007](#)  
[C501106015](#) [C501106025](#) [C601102010](#) [C601104010](#) [C601106007](#) [C601106015](#) [2142758-2](#) [2168427-2](#) [CAT1106007](#) [21949-1](#) [2J1866A](#)  
[RJF SFTP 5E 0500](#) [AX100351](#) [MN14CEC/ST](#) [C501100015](#) [C501106004](#) [C501106010](#) [C5F1108007](#) [C601104004](#) [C601106004](#)  
[CA21106004](#) [CA21106010](#) [CA21106015](#) [CA21109007](#)