

Network cable - NBC-FSD/10,0-93B/R4ACR SCO - 1407539

Please be informed that the data shown in this PDF Document is generated from our Online Catalog. Please find the complete data in the user's documentation. Our General Terms of Use for Downloads are valid (<http://phoenixcontact.com/download>)



Network cable, PROFINET CAT5 (100 Mbps), EtherCAT® CAT5 (100 Mbps), 4-position, PVC/PVC, green RAL 6018, shielded, Plug angled RJ45 / IP20, on Socket straight M12 SPEEDCON / IP67, coding: D, cable length: 10 m



Key Commercial Data

Packing unit	1 pc
GTIN	 4 046356 778442
GTIN	4046356778442

Technical data

Dimensions

Length of cable	10 m
-----------------	------

Ambient conditions

Degree of protection	IP65 (M12 connector)
	IP67 (M12 connector)
	IP20 (RJ45 connector)
Ambient temperature (operation)	-25 °C ... 85 °C (M12 connector)
	-25 °C ... 60 °C (RJ45 connector)

General data

Note	This product corresponds to the PROFINET Cabling and Interconnection Technology Guideline for PROFINET regulations, version 2.00, order no: 2.252, Chapter 8.2 Connectors for Outside Environment (Balanced cabling)
	Further products with variable cable type and variable cable length can be found in the accessories section
Rated current at 40°C	1 A
Rated voltage	48 V AC
	60 V DC
Number of positions	4

Network cable - NBC-FSD/10,0-93B/R4ACR SCO - 1407539

Technical data

General data

Signal type/category	PROFINET CAT5 (IEC 11801), 100 Mbps
	EtherCAT® CAT5 (IEC 11801), 100 Mbps
Standards/regulations	M12 connector IEC 61076-2-101
Contact material	CuSn
Contact carrier material	TPU GF
Contact surface material	Ni/Au
Housing material	Plastic
Degree of protection	IP67/IP20
Transmission characteristics (category)	CAT5

Characteristics head 1

Head type	Plug angled RJ45 / IP20
No. of positions (pin connector pattern)	4 (8)
Color	black
Material (component)	CuSn (Contact)
	Ni/Au (Contact surface)
	PA (Contact carriers)
	PA (Housing)
Insertion/withdrawal cycles	≥ 750
Ambient temperature (operation)	-25 °C ... 80 °C
Shielded	yes
Outer sheath, material	PVC
External sheath, color	green RAL 6018
Type type, plug side	Plug angled
Type type, socket side	Socket, straight

Characteristics head 2

Head type	Socket straight M12 SPEEDCON / IP67
No. of positions (pin connector pattern)	4
Coding	D (Data)
Color	black
	gray / black
Material (component)	CuSn (Contact)
	Ni/Au (Contact surface)
	TPU GF (Contact carriers)
	TPU, hardly inflammable, self-extinguishing (Grip)
	Zinc die-cast, nickel-plated (Screw connection)
Insulation resistance	≥ 100 MΩ
Insertion/withdrawal cycles	≥ 100
Torque	0.4 Nm
Ambient temperature (operation)	-25 °C ... 90 °C

Network cable - NBC-FSD/10,0-93B/R4ACR SCO - 1407539

Technical data

Standards and Regulations

Standards/specifications	M12 connector IEC 61076-2-101
--------------------------	-------------------------------

Cable

Cable type	PROFINET PVC stranded CAT5
Cable type (abbreviation)	93B
UL AWM style	21694
Signal type/category	PROFINET CAT5 (IEC 11801), 100 Mbps EtherCAT® CAT5 (IEC 11801), 100 Mbps
Cable structure	1x4xAWG22/7; SF/TQ
Conductor cross section	4x 0.34 mm ²
AWG signal line	22
Conductor structure signal line	7x 0.25 mm
Core diameter including insulation	1.55 mm
Wire colors	White, yellow, blue, orange
Overall twist	Star quad
Shielding	Aluminum-coated foil, tinned copper braided shield
Optical shield covering	85 %
External sheath, color	green RAL 6018
Outer sheath thickness	approx. 0.9 mm
External cable diameter D	6.5 mm ±0.2 mm
Minimum bending radius, fixed installation	3 x D
Minimum bending radius, flexible installation	7 x D
Cable weight	67 kg/km
Outer sheath, material	PVC
Material, inner sheath	PVC
Material conductor insulation	PE
Conductor material	Tin-plated Cu litz wires
Insulation resistance	≥ 500 MΩ*km
Loop resistance	≤ 120.00 Ω/km
Wave impedance	100 Ω ±15 Ω (at 100 MHz)
Near end crosstalk attenuation (NEXT)	80 dB (with 1 MHz) 76 dB (at 4 MHz) 70 dB (at 10 MHz) 65 dB (at 16 MHz) 63 dB (at 20 MHz) 60 dB (at 31.25 MHz) 55 dB (at 62.5 MHz) 50 dB (at 100 MHz)
Attenuation	2.1 dB (with 1 MHz) 4 dB (at 4 MHz) 6.3 dB (at 10 MHz)

Network cable - NBC-FSD/10,0-93B/R4ACR SCO - 1407539

Technical data

Cable

	8 dB (at 16 MHz)
	9 dB (at 20 MHz)
	11.4 dB (at 31.25 MHz)
	16.5 dB (at 62.5 MHz)
	21.3 dB (at 100 MHz)
Signal speed	0.66 c
Signal runtime	5.3 ns/m
Coupling resistance	≤ 20.00 mΩ/m (at 10 MHz)
Nominal voltage, cable	600 V
Test voltage Core/Core	2000 V (50 Hz, 1 min.)
Test voltage Core/Shield	2000 V (50 Hz, 1 min.)
Flame resistance	according to UL 1685 (CSA FT 4)
Resistance to oil	Resistant to oil to a limited extent
Other resistance	UV resistant According to UL 1581, Section 1200
Ambient temperature (operation)	-40 °C ... 70 °C (cable, fixed installation)
	-40 °C ... 70 °C (cable, flexible installation)
Ambient temperature (installation)	-20 °C ... 60 °C
Ambient temperature (storage/transport)	-50 °C ... 70 °C

Environmental Product Compliance

China RoHS	Environmentally friendly use period: unlimited = EFUP-e
	No hazardous substances above threshold values

Drawings

Network cable - NBC-FSD/10,0-93B/R4ACR SCO - 1407539

Schematic diagram

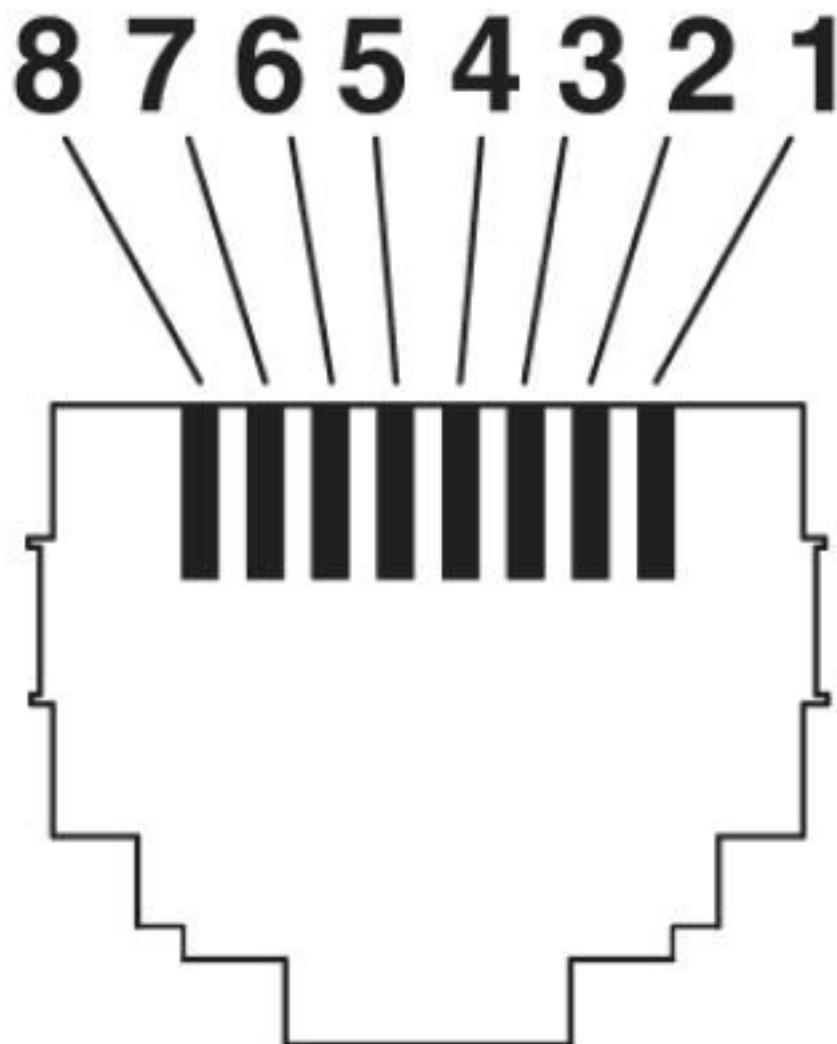

Connector pin assignment plug RJ45

Network cable - NBC-FSD/10,0-93B/R4ACR SCO - 1407539

Dimensional drawing

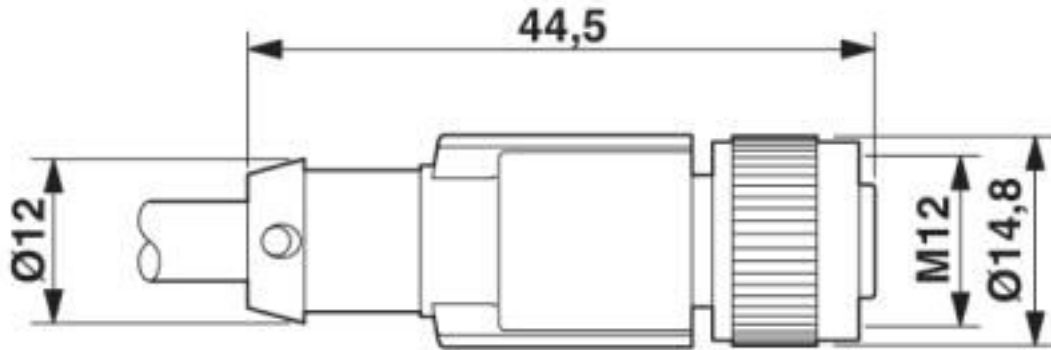

M12 x 1 socket, straight, shielded

Dimensional drawing

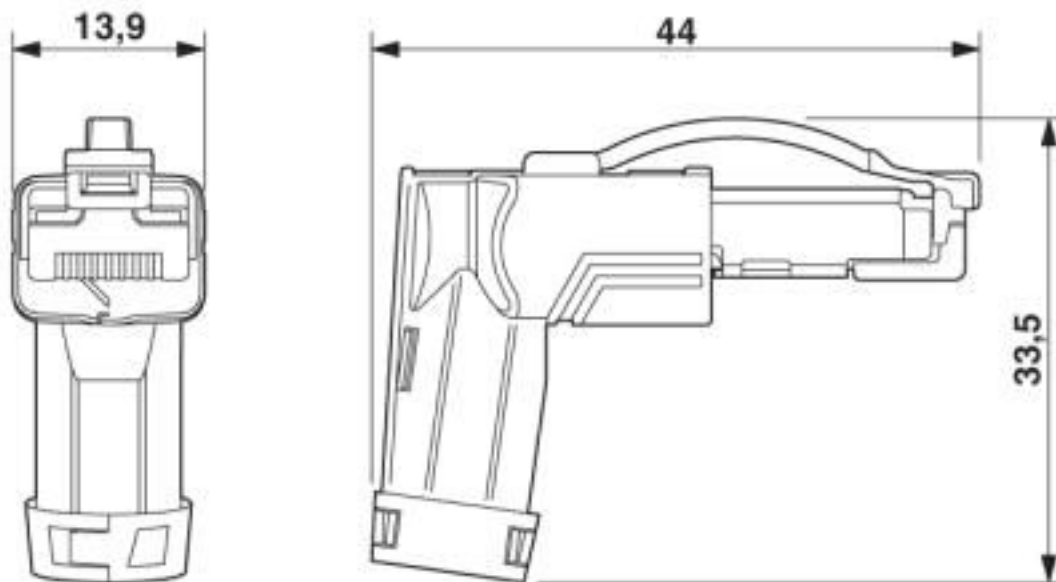

RJ45 connector, IP20, angled

Network cable - NBC-FSD/10,0-93B/R4ACR SCO - 1407539

Circuit diagram

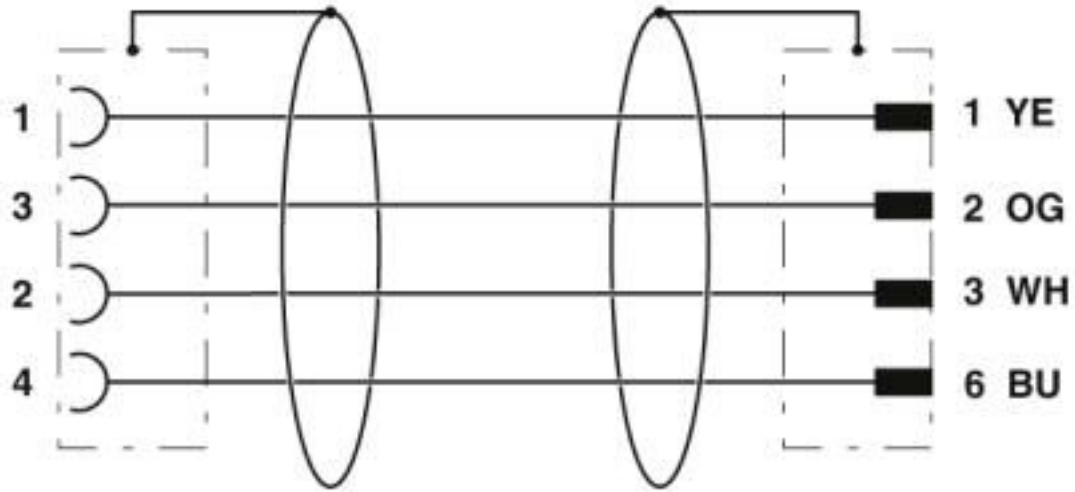

Contact assignment of the M12 socket and the RJ45 plug

Network cable - NBC-FSD/10,0-93B/R4ACR SCO - 1407539

Schematic diagram

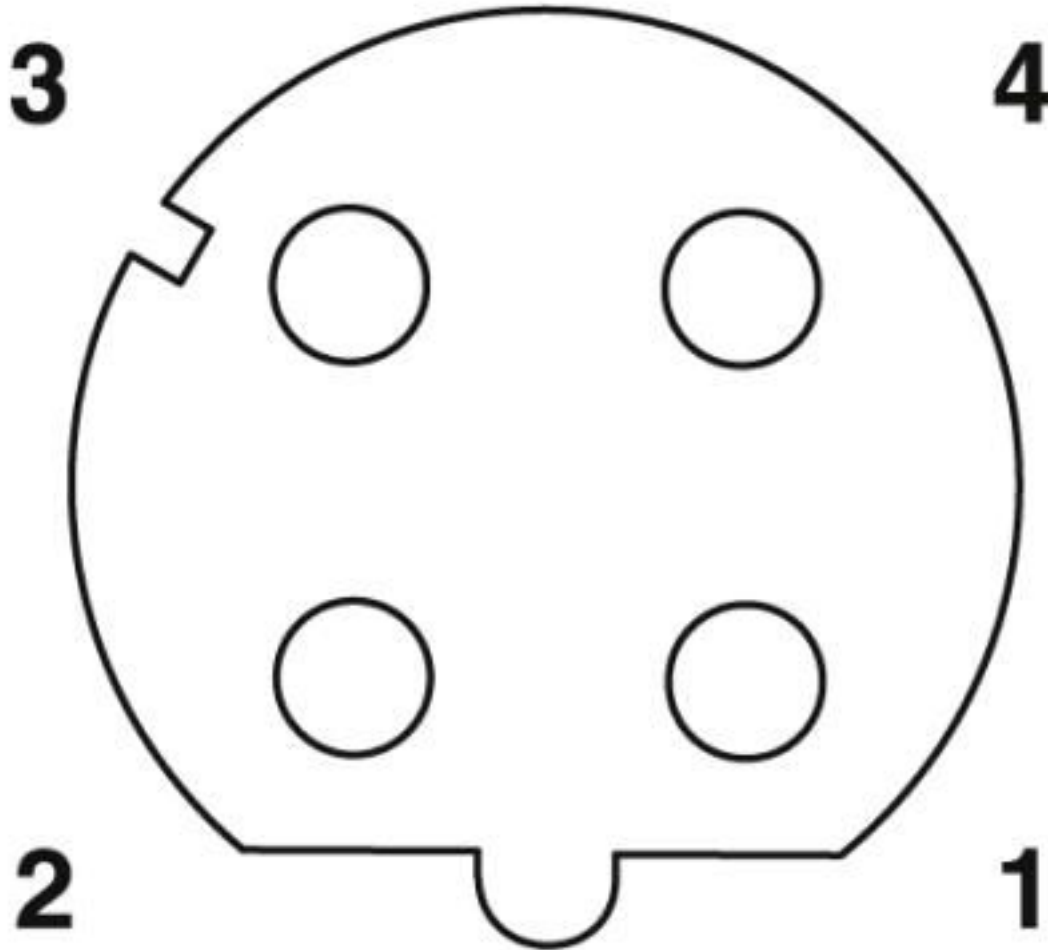

Pin assignment M12 socket, 4-pos., D-coded, female side

Network cable - NBC-FSD/10,0-93B/R4ACR SCO - 1407539

Cable cross section

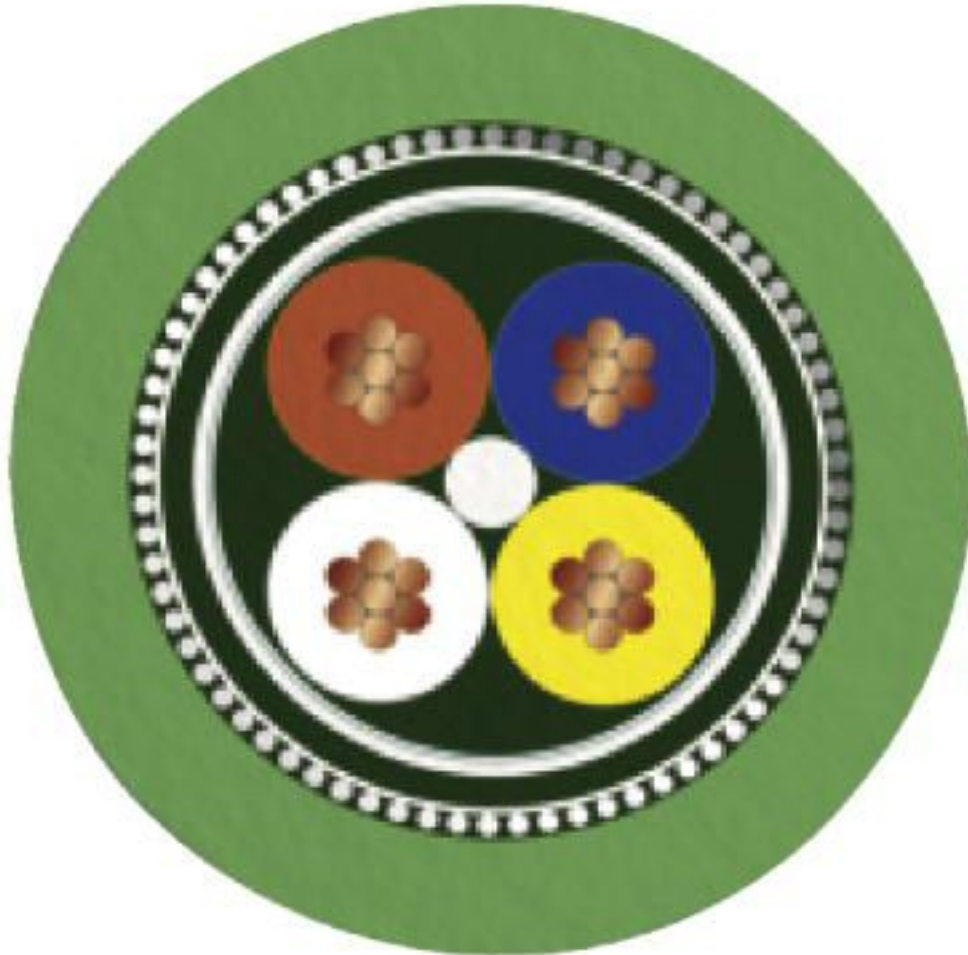

PROFINET PVC stranded CAT5 [93B]

Classifications

eCl@ss

eCl@ss 10.0.1	27060308
eCl@ss 4.0	24010400
eCl@ss 4.1	24010400
eCl@ss 5.0	19030300
eCl@ss 5.1	19030300
eCl@ss 6.0	27061800
eCl@ss 7.0	27061801
eCl@ss 8.0	27061801
eCl@ss 9.0	27060308

Network cable - NBC-FSD/10,0-93B/R4ACR SCO - 1407539

Classifications

ETIM

ETIM 3.0	EC000830
ETIM 4.0	EC001855
ETIM 5.0	EC002599
ETIM 6.0	EC001262
ETIM 7.0	EC001262

UNSPSC

UNSPSC 6.01	31261501
UNSPSC 7.0901	31261501
UNSPSC 11	31261501
UNSPSC 12.01	31261501
UNSPSC 13.2	26121604
UNSPSC 18.0	26121604
UNSPSC 19.0	26121604
UNSPSC 20.0	26121604
UNSPSC 21.0	26121604

Approvals

Approvals

Approvals

UL Listed / cUL Listed / EAC-RoHS / cULus Listed

Ex Approvals

Approval details

UL Listed		http://database.ul.com/cgi-bin/XYV/template/LISEXT/1FRAME/index.htm	FILE E 335024
Nominal voltage UN	30 V		
Nominal current IN	4 A		

cUL Listed		http://database.ul.com/cgi-bin/XYV/template/LISEXT/1FRAME/index.htm	FILE E 335024
Nominal voltage UN	60 V		

Network cable - NBC-FSD/10,0-93B/R4ACR SCO - 1407539

Approvals

Nominal current I _N	0.5 A
--------------------------------	-------

EAC-RoHS		RU D-DE.HB35.B.00387
----------	--	----------------------

cULus Listed	
--------------	--

Accessories

Accessories

Data cable preassembled

Network cable - NBC-MSD-R4AC SCO-PN/.../... - 1408639



Network cable, PROFINET CAT5 (100 Mbps), EtherCAT® CAT5 (100 Mbps), 4-position, Variable cable type, shielded, Plug straight M12 SPEEDCON / IP67, coding: D, on Plug straight RJ45 / IP20, cable length: Free input (0.2 ... 40.0 m)

Network cable - NBC-MSD-R4ACR SCO-PN/.../... - 1408638



Network cable, PROFINET CAT5 (100 Mbps), EtherCAT® CAT5 (100 Mbps), 4-position, Variable cable type, shielded, Plug straight M12 SPEEDCON / IP67, coding: D, on Plug angled RJ45 / IP20, cable length: Free input (0.2 ... 40.0 m)

Network cable - NBC-MRD-R4AC SCO-PN/.../... - 1408632



Network cable, PROFINET CAT5 (100 Mbps), EtherCAT® CAT5 (100 Mbps), 4-position, Variable cable type, shielded, Plug angled M12 SPEEDCON / IP67, coding: D, on Plug straight RJ45 / IP20, cable length: Free input (0.2 ... 40.0 m)

Network cable - NBC-MRD-R4ACR SCO-PN/.../... - 1408631



Network cable, PROFINET CAT5 (100 Mbps), EtherCAT® CAT5 (100 Mbps), 4-position, Variable cable type, shielded, Plug angled M12 SPEEDCON / IP67, coding: D, on Plug angled RJ45 / IP20, cable length: Free input (0.2 ... 40.0 m)

Network cable - NBC-FSD/10,0-93B/R4ACR SCO - 1407539

Accessories

Network cable - NBC-FSD-R4AC SCO-PN/.../... - 1408622



Network cable, PROFINET CAT5 (100 Mbps), EtherCAT® CAT5 (100 Mbps), 4-position, Variable cable type, shielded, Plug straight RJ45 / IP20, on Socket straight M12 SPEEDCON / IP67, coding: D, cable length: Free input (0.2 ... 40.0 m)

Network cable - NBC-FSD-R4ACR SCO-PN/.../... - 1408621



Network cable, PROFINET CAT5 (100 Mbps), EtherCAT® CAT5 (100 Mbps), 4-position, Variable cable type, shielded, Plug angled RJ45 / IP20, on Socket straight M12 SPEEDCON / IP67, coding: D, cable length: Free input (0.2 ... 40.0 m)

Network cable - NBC-FRD-R4AC SCO-PN/.../... - 1408613



Network cable, PROFINET CAT5 (100 Mbps), EtherCAT® CAT5 (100 Mbps), 4-position, Variable cable type, shielded, Plug straight RJ45 / IP20, on Socket angled M12 SPEEDCON / IP67, coding: D, cable length: Free input (0.2 ... 40.0 m)

Network cable - NBC-FRD-R4ACR SCO-PN/.../... - 1408612



Network cable, PROFINET CAT5 (100 Mbps), EtherCAT® CAT5 (100 Mbps), 4-position, Variable cable type, shielded, Plug angled RJ45 / IP20, on Socket angled M12 SPEEDCON / IP67, coding: D, cable length: Free input (0.2 ... 40.0 m)

Plug for cable screw gland

Screw plug - PROT-M12 MS-PA-CHAIN - 1430899

M12 sealing cap with fixing band, for sensor cables, for free M12 sockets



Safety locking

Network cable - NBC-FSD/10,0-93B/R4ACR SCO - 1407539

Accessories

Locking clip - SAC-M12-EXCLIP-F - 1558991



Locking clip for the socket side of sensor/actuator cables with M12 connector and M12 connectors for assembly, for knurl diameter: 15 mm or for Allen key with a wrench size of 14 mm, prevents the disconnection of plug-in connections without tools

Screwdriver tools

Adapter insert - TSD-M SAC-BIT ADAPTER - 1212600



Adapter bit for TSD-M...torque tools, E6.3-1/4" drive with 4 mm hexagon to accommodate SAC bits

Tool - SAC BIT M12-D15 - 1208432



Nut for assembling sensor/actuator cables with M12 connector and M12 connectors for assembly, with a knurl diameter of 15 mm, for 4 mm hexagonal drive

Torque tool

Torque screwdriver - TSD 04 SAC - 1208429



Torque screwdriver, with preset torque of 0.4 Nm and 4 mm hexagonal drive for M12 connectors

Torque screwdriver - TSD-M 1,2NM - 1212224



Torque screw driver, accuracy as per EN ISO 6789 standard, adjustable from 0.3 - 1.2 Nm

Phoenix Contact 2020 © - all rights reserved
<http://www.phoenixcontact.com>

PHOENIX CONTACT GmbH & Co. KG
Flachsmarktstr. 8
32825 Blomberg
Germany
Tel. +49 5235 300
Fax +49 5235 3 41200
<http://www.phoenixcontact.com>

X-ON Electronics

Largest Supplier of Electrical and Electronic Components

Click to view similar products for [Ethernet Cables / Networking Cables](#) category:

Click to view products by [Phoenix Contact](#) manufacturer:

Other Similar products are found below :

[73-6670-7](#) [73-6680-15](#) [73-7797-25](#) [MCJB2-10P6Q7-120](#) [84909-0204](#) [1200700174](#) [1200860368](#) [E16A06002M030](#) [E200102-009-S1](#)
[AX105346-EW](#) [MT14-187L](#) [17-103530](#) [ERWPAB3002M005](#) [190-038045-01](#) [NK5EPC18RDY](#) [NK5EPC18VLY](#) [NK5EPC18YLY](#)
[NK5EPC1GRY](#) [NK5EPC4Y](#) [NK5EPC6YLY](#) [NK5EPC8BLY](#) [NK5EPC9YLY](#) [1969343-6](#) [C501100010](#) [C501106002](#) [C501106007](#)
[C501106015](#) [C501106025](#) [C601102010](#) [C601104010](#) [C601106007](#) [C601106015](#) [2142758-2](#) [2168427-2](#) [CAT1106007](#) [21949-1](#) [2J1866A](#)
[RJF SFTP 5E 0500](#) [AX100351](#) [MN14CEC/ST](#) [C501100015](#) [C501106004](#) [C501106010](#) [C5F1108007](#) [C601104004](#) [C601106004](#)
[CA21106004](#) [CA21106010](#) [CA21106015](#) [CA21109007](#)