

Network cable - NBC-R4RC/2,0-93E/R4RC - 1408942

Please be informed that the data shown in this PDF Document is generated from our Online Catalog. Please find the complete data in the user's documentation. Our General Terms of Use for Downloads are valid (<http://phoenixcontact.com/download>)



Assembled Ethernet cable, CAT5e, shielded, 2-pair, 26 AWG stranded (7-wire), RAL 5021 (water blue), RJ45 plug/IP67 push/pull metal housing to RJ45 plug/IP67 push/pull metal housing, line, length: 2 m



Key Commercial Data

Packing unit	1 pc
GTIN	 4 046356 856713
GTIN	4046356856713

Technical data

Dimensions

Length of cable	2.00 m
-----------------	--------

Ambient conditions

Degree of protection	IP67 (RJ45 connector)
Ambient temperature (operation)	-40 °C ... 70 °C (RJ45 connector)

General data

Rated current at 40°C	1 A
Rated voltage	48 V
Number of positions	4
Standards/regulations	IEC PAS 61076-3-117
Degree of pollution	2
Alternative short product description	Ethernet cable
Locking type	Push Pull
Rated voltage (III/3)	72 V (DC)
Degree of protection	IP65/IP67
Number of slots	1
Transmission characteristics (category)	CAT5

Network cable - NBC-R4RC/2,0-93E/R4RC - 1408942

Technical data

Characteristics head 1

Color	silver
Material (component)	CuSn (Contact)
	Ni/Au (Contact surface)
	PC (Contact carriers)
	Zinc die-cast, nickel-plated (Housing)
Insertion/withdrawal cycles	≥ 750
Ambient temperature (operation)	-40 °C ... 70 °C
Shielded	yes
Outer sheath, material	PUR
External sheath, color	water blue RAL 5021
Type type, plug side	Plug straight
Type type, socket side	Plug, straight

Characteristics head 2

Color	silver
Material (component)	CuSn (Contact)
	Ni/Au (Contact surface)
	PC (Contact carriers)
	Zinc die-cast, nickel-plated (Housing)
Insertion/withdrawal cycles	≥ 750
Ambient temperature (operation)	-40 °C ... 70 °C

Standards and Regulations

Standards/specifications	IEC PAS 61076-3-117
Flammability rating according to UL 94	V2

Cable

Cable type	Ethernet flexible CAT5, 2-pair
Cable type (abbreviation)	93E
UL AWM style	20963 (80°C/30 V)
Signal type/category	Ethernet CAT5 (IEC 11801), 100 Mbps
Cable structure	2x2xAWG26/7; SF/UTP
Conductor cross section	2x 2x 0.14 mm ²
AWG signal line	26
Conductor structure signal line	7x 0.16 mm
Core diameter including insulation	0.98 mm
Wire colors	white/orange-orange, white/green-green
Twisted pairs	2 cores to the pair
Overall twist	Two pairs with two fillers to the core
Shielding	Aluminum-coated foil, tinned copper braided shield
Optical shield covering	70 %
External sheath, color	water blue RAL 5021

Network cable - NBC-R4RC/2,0-93E/R4RC - 1408942

Technical data

Cable

Outer sheath thickness	1.2 mm
External cable diameter D	6.4 mm ±0.2 mm
Minimum bending radius, fixed installation	4 x D
Minimum bending radius, flexible installation	8 x D
Tensile strength GRP	≤ 80 N
Cable weight	42 kg/km
Outer sheath, material	PUR
Material conductor insulation	Foamed PE
Conductor material	Bare Cu litz wires
Standards/specifications	Electrical requirements EN 50288-2-2
Insulation resistance	≥ 500 MΩ*km
Loop resistance	≤ 290.00 Ω/km
Cable capacity	approx. 45 nF/km (at 1 kHz)
Wave impedance	100 Ω ±5 Ω (at 100 MHz)
Near end crosstalk attenuation (NEXT)	65.3 dB (with 1 MHz)
	56.3 dB (at 4 MHz)
	50.3 dB (at 10 MHz)
	47.2 dB (at 16 MHz)
	45.8 dB (at 20 MHz)
	42.9 dB (at 31.25 MHz)
	38.4 dB (at 62.5 MHz)
	35.3 dB (at 100 MHz)
Power-summated near end crosstalk attenuation (PSNEXT)	62.3 dB (with 1 MHz)
	53.3 dB (at 4 MHz)
	47.3 dB (at 10 MHz)
	44.2 dB (at 16 MHz)
	42.8 dB (at 20 MHz)
	39.9 dB (at 31.25 MHz)
	35.4 dB (at 62.5 MHz)
	32.3 dB (at 100 MHz)
Attenuation	3.2 dB (with 1 MHz)
	6 dB (at 4 MHz)
	9.5 dB (at 10 MHz)
	12.1 dB (at 16 MHz)
	13.6 dB (at 20 MHz)
	17.1 dB (at 31.25 MHz)
	24.8 dB (at 62.5 MHz)
	32 dB (at 100 MHz)
Return loss (RL)	23 dB (at 4 MHz)
	24.1 dB (at 8 MHz)

Network cable - NBC-R4RC/2,0-93E/R4RC - 1408942

Technical data

Cable

	25 dB (at 10 MHz)
	25 dB (at 16 MHz)
	25 dB (at 20 MHz)
	23.6 dB (at 31.25 MHz)
	21.5 dB (at 62.5 MHz)
	20.1 dB (at 100 MHz)
Signal runtime	5.3 ns/m
Coupling resistance	≤ 100.00 mΩ/m (at 10 MHz)
Nominal voltage, cable	≤ 100 V (Peak value, not for high-power applications)
Test voltage Core/Core	700 V (50 Hz, 1 min.)
Test voltage Core/Shield	700 V (50 Hz, 1 min.)
Current carrying capacity of cable	2 A (according to DIN VDE 0891-1)
Flame resistance	according to IEC 60332-1-2
	in acc. to UL VW1
Halogen-free	according to IEC 60754-1
Resistance to oil	according to EN 60811-2-1
Ambient temperature (operation)	-40 °C ... 80 °C (cable, fixed installation)
	-20 °C ... 80 °C (cable, flexible installation)
Ambient temperature (installation)	-20 °C ... 80 °C
Ambient temperature (storage/transport)	-20 °C ... 80 °C

Environmental Product Compliance

REACH SVHC	Lead 7439-92-1
China RoHS	Environmentally Friendly Use Period = 50 years
	For details about hazardous substances go to tab "Downloads", Category "Manufacturer's declaration"

Drawings

Network cable - NBC-R4RC/2,0-93E/R4RC - 1408942

Schematic diagram



Connector pin assignment plug RJ45

Network cable - NBC-R4RC/2,0-93E/R4RC - 1408942

Dimensional drawing

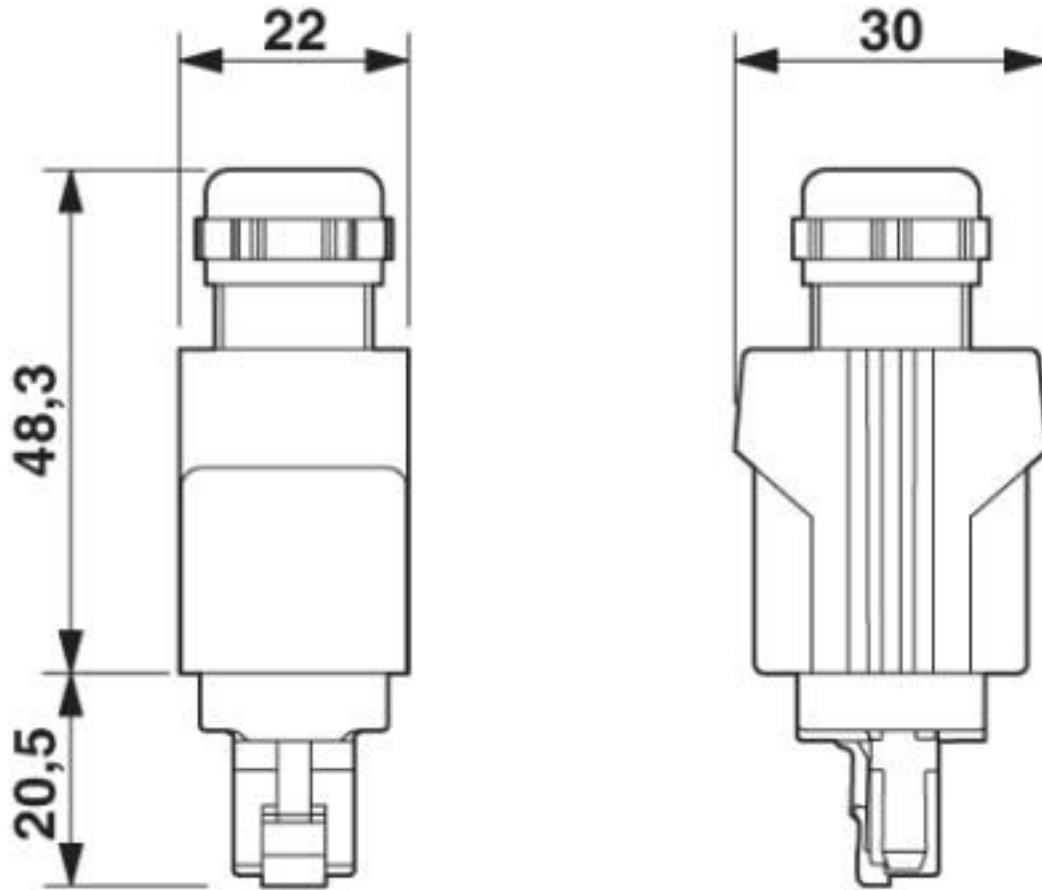

RJ45 Push-Pull connector, IP67

Circuit diagram

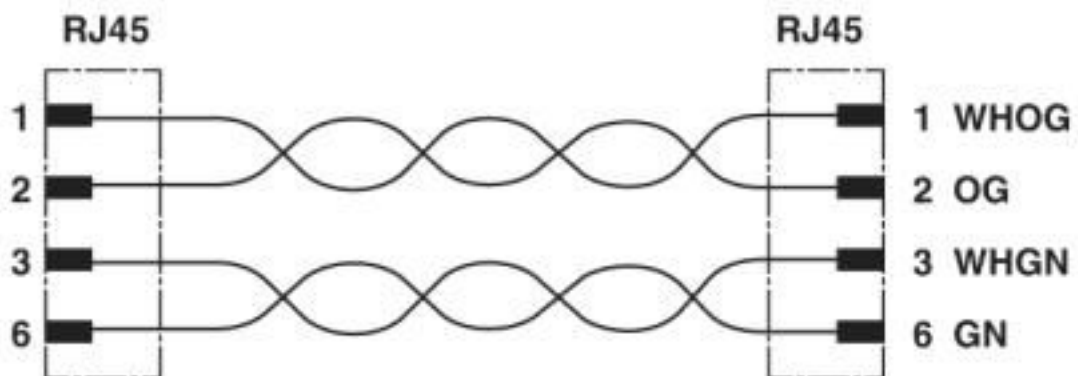

Contact assignment of RJ45 plugs

Network cable - NBC-R4RC/2,0-93E/R4RC - 1408942

Cable cross section

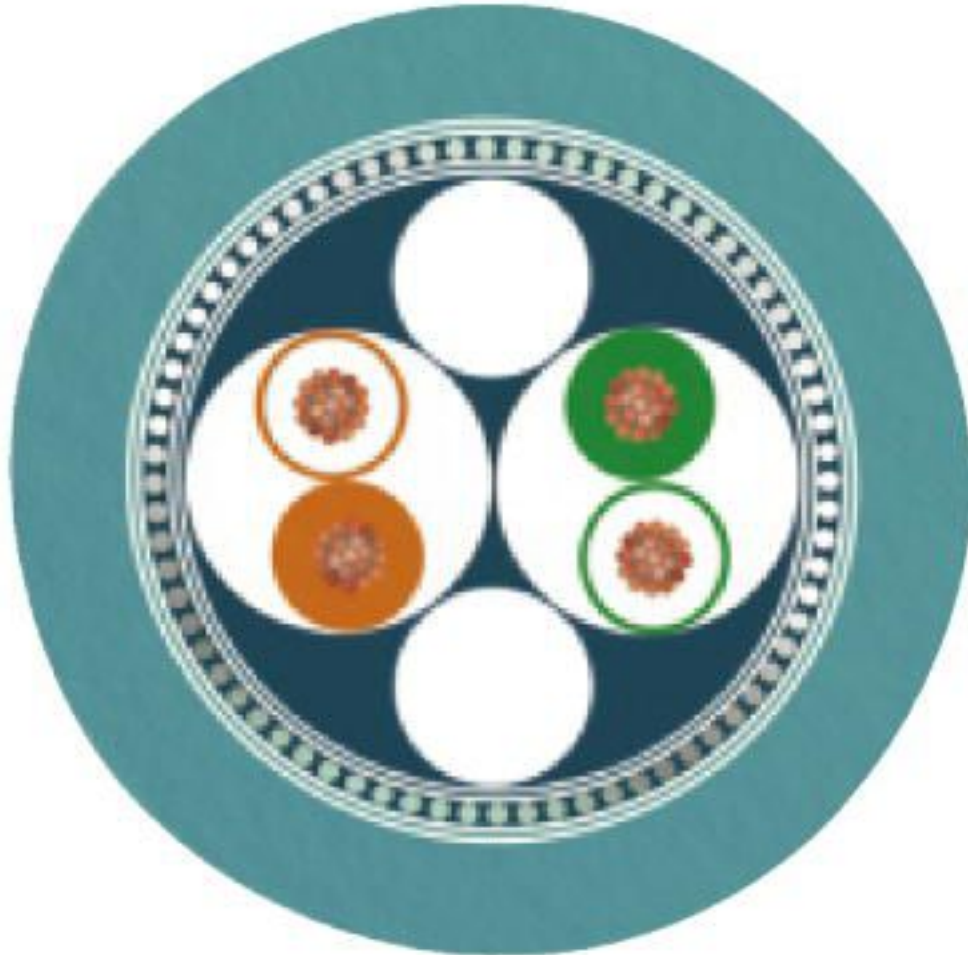

Ethernet flexible CAT5, 2-pair [93E]

Classifications

eCl@ss

eCl@ss 10.0.1	27060308
eCl@ss 4.0	24010400
eCl@ss 4.1	24010400
eCl@ss 5.0	19030300
eCl@ss 5.1	19030300
eCl@ss 6.0	27061800
eCl@ss 7.0	27060308
eCl@ss 8.0	27060308
eCl@ss 9.0	27060308

Network cable - NBC-R4RC/2,0-93E/R4RC - 1408942

Classifications

ETIM

ETIM 3.0	EC000830
ETIM 4.0	EC002599
ETIM 5.0	EC002599
ETIM 6.0	EC001262
ETIM 7.0	EC001262

UNSPSC

UNSPSC 6.01	26121616
UNSPSC 7.0901	26121616
UNSPSC 11	26121604
UNSPSC 12.01	31261501
UNSPSC 13.2	26121604
UNSPSC 18.0	26121604
UNSPSC 19.0	26121604
UNSPSC 20.0	26121604
UNSPSC 21.0	26121604

Approvals

Approvals

Approvals

EAC

Ex Approvals

Approval details

EAC		19060508
-----	---	----------

X-ON Electronics

Largest Supplier of Electrical and Electronic Components

Click to view similar products for [Ethernet Cables / Networking Cables](#) category:

Click to view products by [Phoenix Contact](#) manufacturer:

Other Similar products are found below :

[73-6670-7](#) [73-6680-15](#) [73-7797-25](#) [MCJB2-10P6Q7-120](#) [84909-0204](#) [1200700174](#) [1200860368](#) [E16A06002M030](#) [E200102-009-S1](#)
[AX105346-EW](#) [MT14-187L](#) [17-103530](#) [ERWPAB3002M005](#) [190-038045-01](#) [NK5EPC18RDY](#) [NK5EPC18VLY](#) [NK5EPC18YLY](#)
[NK5EPC1GRY](#) [NK5EPC4Y](#) [NK5EPC6YLY](#) [NK5EPC8BLY](#) [NK5EPC9YLY](#) [1969343-6](#) [C501100010](#) [C501106002](#) [C501106007](#)
[C501106015](#) [C501106025](#) [C601102010](#) [C601104010](#) [C601106007](#) [C601106015](#) [2142758-2](#) [2168427-2](#) [CAT1106007](#) [21949-1](#) [2J1866A](#)
[RJF SFTP 5E 0500](#) [AX100351](#) [MN14CEC/ST](#) [C501100015](#) [C501106004](#) [C501106010](#) [C5F1108007](#) [C601104004](#) [C601106004](#)
[CA21106004](#) [CA21106010](#) [CA21106015](#) [CA21109007](#)