

Bus system cable - SAC-5P-M12MS/ 5,0-92X SH OD - 1410472

Please be informed that the data shown in this PDF Document is generated from our Online Catalog. Please find the complete data in the user's documentation. Our General Terms of Use for Downloads are valid (<http://phoenixcontact.com/download>)



Bus system cable, CANopen®, DeviceNet™, 5-position, FRNC halogen-free, black, shielded, Plug straight M12, coding: A, on free cable end, cable length: 5 m, for outdoor applications, with high-grade steel knurl

Your advantages

- ✓ Easy and safe: 100% electrically tested plug-in components
- ✓ Corrosion protection for all exposed metal parts, thanks to the use of stainless steel type 1.4404
- ✓ Robust throughout: resistant to oil, UV, and ozone, withstands temperatures from -40°C to +105°C
- ✓ Reliable signal transmission – 360° shielding in environments with electromagnetic interference



CANopen®/DeviceNet™

Key Commercial Data

Packing unit	1 pc
GTIN	 4 046356 899383
GTIN	4046356899383

Technical data

Dimensions

Length of cable	5 m
-----------------	-----

Ambient conditions

Ambient temperature (operation)	-40 °C ... 105 °C (Plug / socket)
	-40 °C ... 85 °C (On sudden changes in temperature (according to IEC 60512-11-4))
Degree of protection	IP65
	IP67
	IP68
	IP69K

General

Rated current at 40°C	4 A
Rated voltage	48 V AC

Bus system cable - SAC-5P-M12MS/ 5,0-92X SH OD - 1410472

Technical data

General

	60 V DC
Number of positions	5
Insulation resistance	≥ 100 MΩ
Coding	A - standard
Standards/regulations	M12 connector IEC 61076-2-101
Signal type/category	CANopen® DeviceNet™
Status display	No
Protective circuit/component	unwired
Degree of pollution	3
Insertion/withdrawal cycles	≥ 100
Torque	0.4 Nm (M12 connector)

Material

Flammability rating according to UL 94	V0
Contact material	CuSn
Contact surface material	Ni/Au
Contact carrier material	PP
Material of grip body	PP
Material, knurls	Stainless steel

Pin assignment

Contact Color (signal designation) Contact (optional)	1 (Plug) SR (shield)
	2 (Plug) RD (V+)
	3 (Plug) BK (V-)
	4 (Plug) WH (CAN_H)
	5 (Plug) BU (CAN_L)

Standards and Regulations

Standards/specifications	M12 connector IEC 61076-2-101
Flammability rating according to UL 94	V0

Cable

Cable type	CANopen®/DeviceNet™ outdoor installation, FRNC, black
Cable type (abbreviation)	92X
Cable abbreviation	LI2XCHX02XS
UL AWM style	21281 (80°C/300 V)
Cable structure	2xAWG24/19+2xAWG22/19
Conductor cross section	2x 0.25 mm² (Signal) 2x 0.34 mm² (Power) 1x 0.38 mm² (Drain wire)
AWG signal line	24
AWG power supply	22

Bus system cable - SAC-5P-M12MS/ 5,0-92X SH OD - 1410472

Technical data

Cable

Conductor structure signal line	19x 0.13 mm
Conductor structure, voltage supply	19x 0.16 mm
Core diameter including insulation	1.9 mm (Signal)
	1.4 mm (Power)
Thickness, insulation	0.6 mm (Signal)
	0.3 mm (Power)
Wire colors	Red-black, blue-white
Twisted pairs	2 cores to the pair
Type of pair shielding	Aluminum-lined foil
Overall twist	2 pairs around a drain wire in the center to the core
Shielding	Tinned copper braided shield
Optical shield covering	70 %
External sheath, color	black
Outer sheath thickness	1.15 mm
External cable diameter D	6.9 mm ±0.3 mm
Minimum bending radius, fixed installation	5 x D
Minimum bending radius, flexible installation	10 x D
Cable weight	70 kg/km
Outer sheath, material	FRNC
Material conductor insulation	PE
Conductor material	Tin-plated Cu litz wires
Insulation resistance	≥ 200 MΩ*km (at 20 °C)
Conductor resistance	90 Ω/km (Signal)
	55 Ω/km (Power)
Working capacitance	39.8 nF (at 1 kHz, core/core)
Wave impedance	120 Ω ±12 Ω (f = 1 MHz)
Signal runtime	4.46 ns/m
Nominal voltage, cable	≤ 300 V
Test voltage Core/Core	2000 V (50 Hz, 1 min.)
Test voltage Core/Shield	2000 V (50 Hz, 1 min.)
Flame resistance	According to IEC 60332-3-25 (Cat. D)
Halogen-free	yes
Resistance to oil	yes
Other resistance	UV resistant
Ambient temperature (operation)	-40 °C ... 105 °C

Environmental Product Compliance

REACH SVHC	Lead 7439-92-1
China RoHS	Environmentally Friendly Use Period = 50 years
	For details about hazardous substances go to tab "Downloads", Category "Manufacturer's declaration"

Bus system cable - SAC-5P-M12MS/ 5,0-92X SH OD - 1410472

Drawings

Dimensional drawing

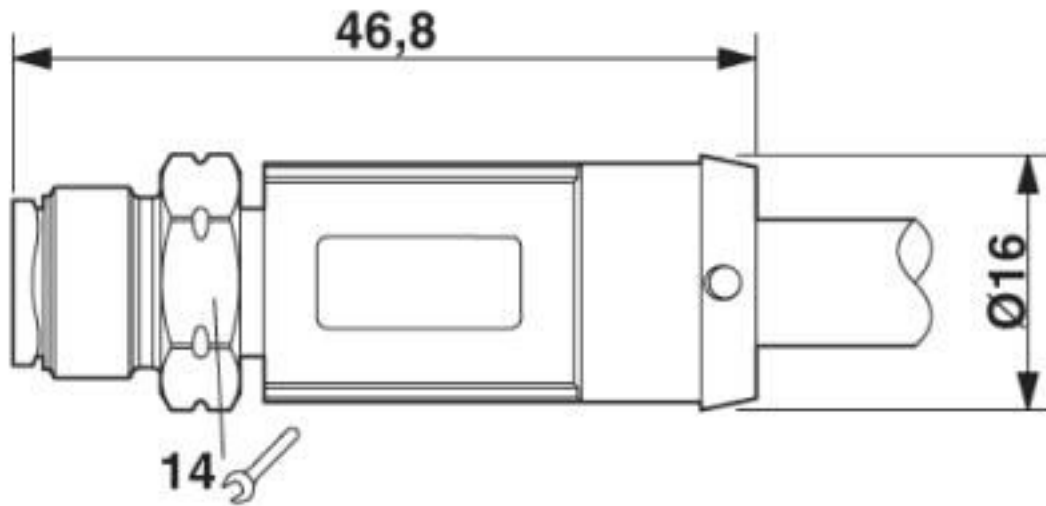

Plug, M12 x 1, straight, shielded

Circuit diagram

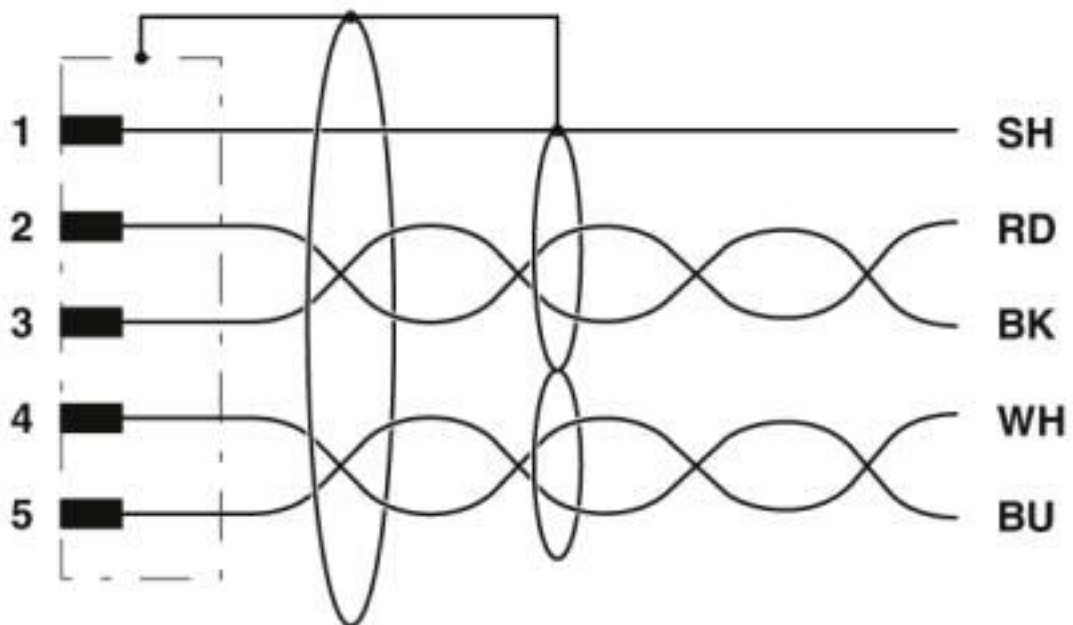

Contact assignment of the M12 plug

Bus system cable - SAC-5P-M12MS/ 5,0-92X SH OD - 1410472

Schematic diagram



Pin assignment M12 male connector, 5-pos., A-coded, male side

Bus system cable - SAC-5P-M12MS/ 5,0-92X SH OD - 1410472

Cable cross section



CANopen[®]/DeviceNet[™] outdoor installation, FRNC, black [92X]

Classifications

eCl@ss

eCl@ss 10.0.1	27060308
eCl@ss 4.0	27060300
eCl@ss 4.1	27060300
eCl@ss 5.0	27061800
eCl@ss 5.1	27061800
eCl@ss 6.0	27279200
eCl@ss 7.0	27279218
eCl@ss 8.0	27279218
eCl@ss 9.0	27060308

Bus system cable - SAC-5P-M12MS/ 5,0-92X SH OD - 1410472

Classifications

ETIM

ETIM 4.0	EC001855
ETIM 5.0	EC002599
ETIM 6.0	EC001262
ETIM 7.0	EC001262

UNSPSC

UNSPSC 13.2	31251501
UNSPSC 18.0	26121604
UNSPSC 19.0	26121604
UNSPSC 20.0	26121604
UNSPSC 21.0	26121604

Approvals

Approvals

Approvals

EAC-RoHS

Ex Approvals

Approval details

EAC-RoHS		RU D- DE.HB35.B.00387
----------	--	--------------------------

Accessories

Accessories

Screwdriver tools

Adapter insert - TSD-M SAC-BIT ADAPTER - 1212600



Adapter bit for TSD-M...torque tools, E6.3-1/4" drive with 4 mm hexagon to accommodate SAC bits

Bus system cable - SAC-5P-M12MS/ 5,0-92X SH OD - 1410472

Accessories

Adapter - SAC BIT M12-W14 - 1212513



Nut for assembling sensor/actuator cables with M12 connector and M12 connectors for assembly, with a hexagonal knurl wrench size of 14 mm, with 4 mm hexagonal drive

Torque tool

Torque screwdriver - TSD 04 SAC - 1208429



Torque screwdriver, with preset torque of 0.4 Nm and 4 mm hexagonal drive for M12 connectors

Torque screwdriver - TSD-M 1,2NM - 1212224



Torque screw driver, accuracy as per EN ISO 6789 standard, adjustable from 0.3 - 1.2 Nm

Phoenix Contact 2020 © - all rights reserved
<http://www.phoenixcontact.com>

PHOENIX CONTACT GmbH & Co. KG
Flachsmarktstr. 8
32825 Blomberg
Germany
Tel. +49 5235 300
Fax +49 5235 3 41200
<http://www.phoenixcontact.com>

X-ON Electronics

Largest Supplier of Electrical and Electronic Components

Click to view similar products for [Sensor Cables / Actuator Cables](#) category:

Click to view products by [Phoenix Contact](#) manufacturer:

Other Similar products are found below :

[60963](#) [60964](#) [703000D02F2002](#) [703001D02F0602](#) [703001D02F300](#) [704000D02F120](#) [773032K02F030](#) [802027107404-1](#) [802027213811-1](#)
[804001A09M150](#) [805001A09M0502](#) [84914-0235](#) [84914-0237](#) [885030A09M020](#) [8R4J30E03C3003](#) [1200651332](#) [1200651713](#) [1200660844](#)
[1200660845](#) [1200661173](#) [1200680071](#) [1200720053](#) [1200720081](#) [1200720099](#) [1200720217](#) [1200800231](#) [1200860125](#) [1200870123](#)
[1200980102](#) [1200650267](#) [1200650298](#) [1200660183](#) [1200660782](#) [1200660849](#) [1200661295](#) [1200661297](#) [1200661342](#) [1200661343](#)
[1200670080](#) [1200670220](#) [1200680331](#) [1200720252](#) [1200730184](#) [1200860344](#) [1200870359](#) [1200870643](#) [1200980008](#) [1200980031](#)
[1210502211](#) [1210400542](#)