

Connector set - HC-EVO-A16UT-BWSC-HH-M25-PLRBK - 1411359

Please be informed that the data shown in this PDF Document is generated from our Online Catalog. Please find the complete data in the user's documentation. Our General Terms of Use for Downloads are valid (<http://phoenixcontact.com/download>)



Connector set, degree of protection: IP66, number of positions: 16, material: PA, connection method: Screw connection, connection cross section: AWG 20- 14



Key Commercial Data

| | |
|--------------|---|
| Packing unit | 1 pc |
| GTIN |  4 046356 929295 |
| GTIN | 4046356929295 |

Technical data

General

| | |
|----------------------------------|--|
| Number of positions | 16+PE |
| Type | D25 |
| Connection method | Screw connection |
| Degree of protection for housing | IP66 |
| | 12 (UL 50e) |
| Connection method | Screw connection |
| Rated voltage (III/3) | 250 V |
| Rated surge voltage | 4 kV |
| Rated current | 20 A |
| Conductor cross section | 0.5 mm ² ... 2.5 mm ² (applies to stranded conductors with ferrules) |
| Connection cross section AWG | 20 ... 14 |
| External cable diameter | 9 mm ... 17 mm |
| Ambient temperature (operation) | -40 °C ... 100 °C |
| Length of the assembly cutout | 74 mm |
| Width of the assembly cutout | 24 mm |
| Housing material | PA |
| Contact carrier material | PC |

Connector set - HC-EVO-A16UT-BWSC-HH-M25-PLRBK - 1411359

Technical data

General

| | |
|-----------------------------|-----|
| Locking latch material | PA |
| Integrated protective cover | Yes |

Standards and Regulations

| | |
|--|----|
| Flammability rating according to UL 94 | V0 |
|--|----|

Environmental Product Compliance

| | |
|------------|---|
| REACH SVHC | Lead 7439-92-1 |
| China RoHS | Environmentally Friendly Use Period = 50 years |
| | For details about hazardous substances go to tab "Downloads", Category "Manufacturer's declaration" |

Drawings

Diagram

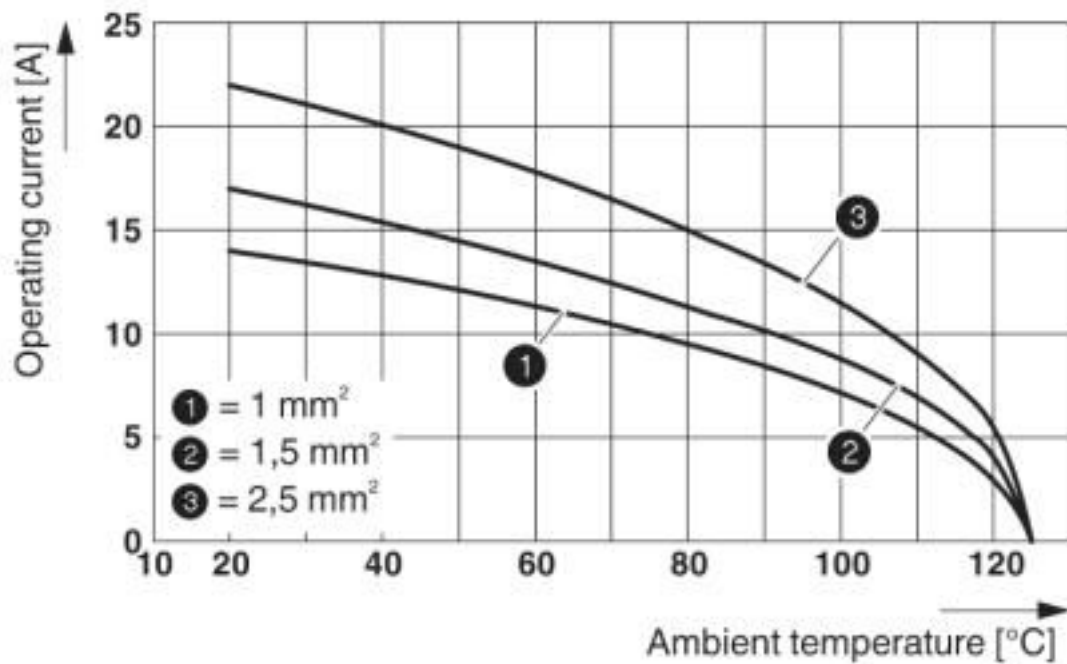

Derating diagram

Connector set - HC-EVO-A16UT-BWSC-HH-M25-PLRBK - 1411359

Dimensional drawing

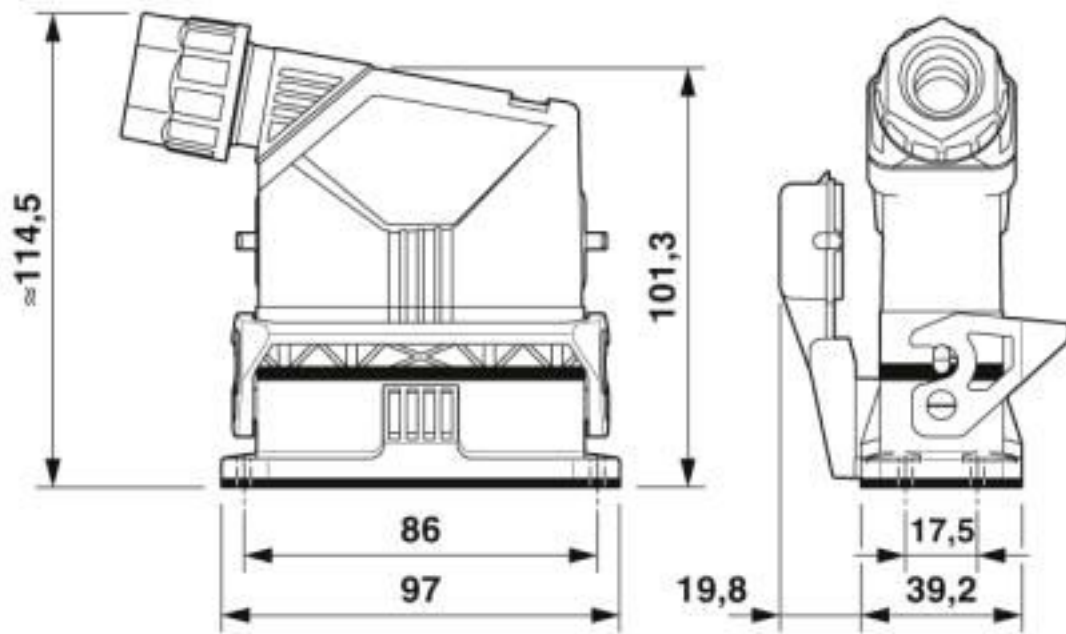

Dimensional drawing

Dimensional drawing

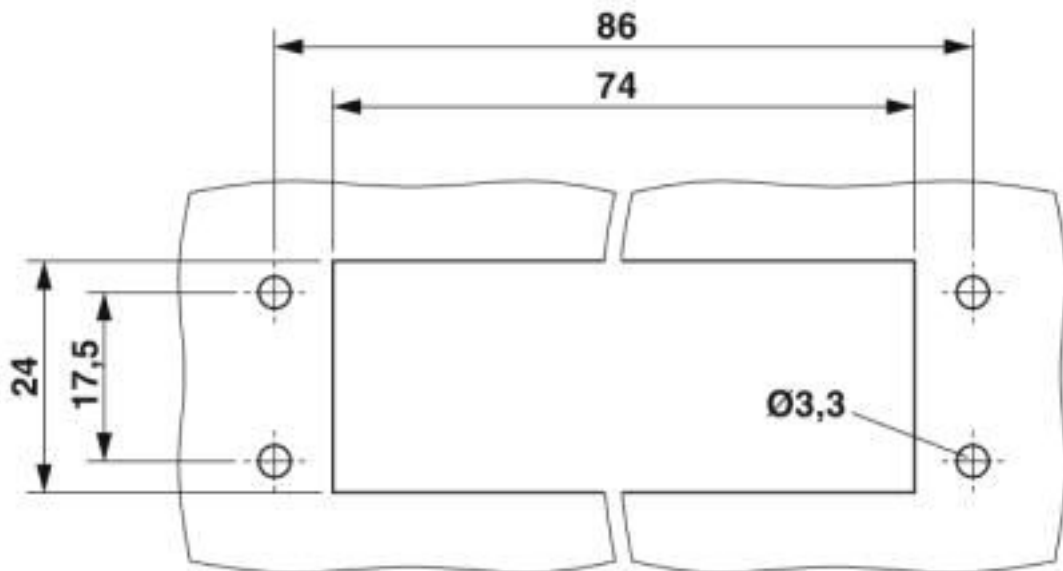

Mounting cutout

Connector set - HC-EVO-A16UT-BWSC-HH-M25-PLRBK - 1411359

Schematic diagram

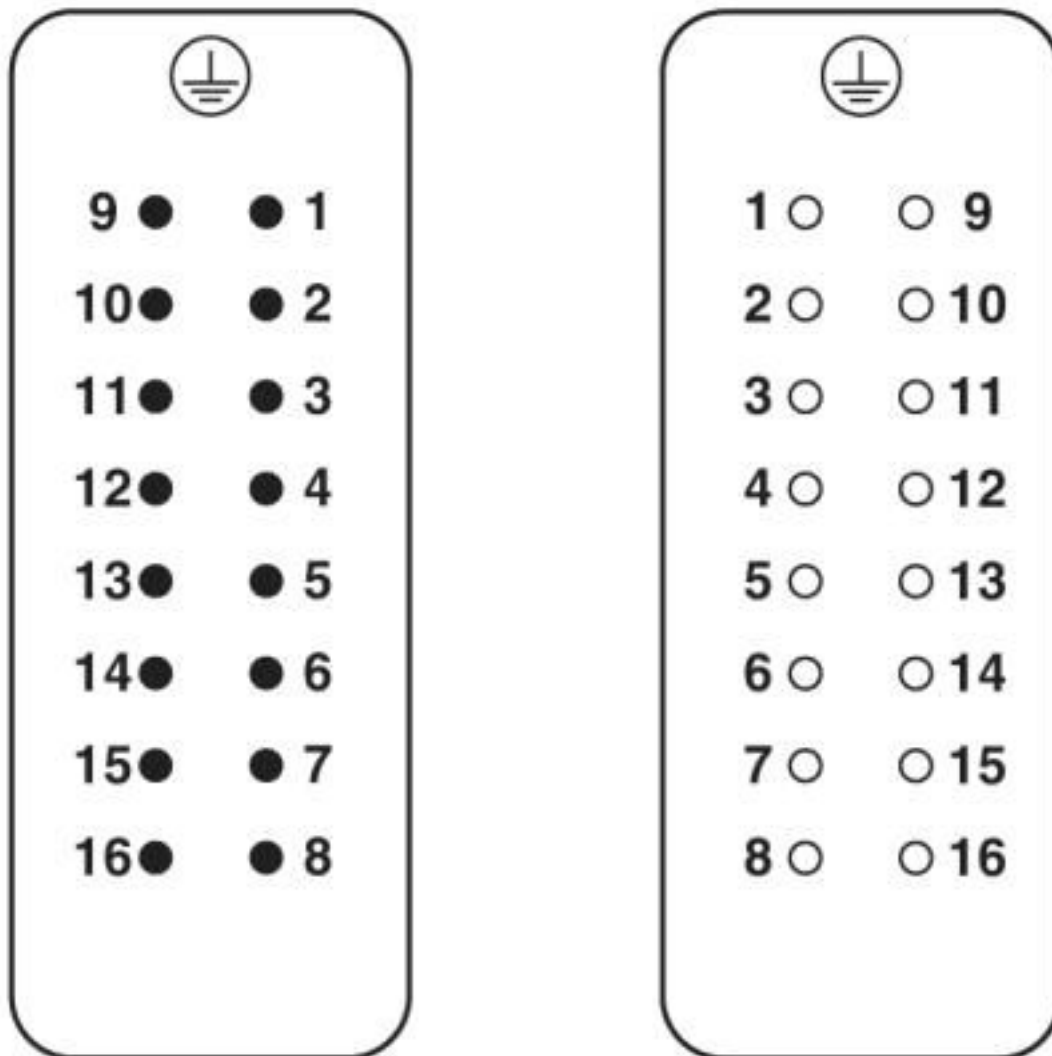

Pin assignment, connection side, pin left, socket right

Articles in set

Housing - HC-EVO-D25-HHFS-PL-BK - 1411347



Sleeve housing D25, for single locking latch, material: PA, cable outlets: 1, straight/lateral, height: 75.5 mm, cable gland: none, support sleeve: no, protective cover: no, Standard

Connector set - HC-EVO-A16UT-BWSC-HH-M25-PLRBK - 1411359

Articles in set

Housing - HC-EVO-D25-BWSC-PLR-BK - 1411345



Panel mounting base D25, with single locking latch, material: PA, protective cover material: PA, height: 26 mm, cable gland: none, support sleeve: no, protective cover: yes, Standard, with flat gasket

Cable gland - HC-D-G-M25-PLRBK - 1411351



EVO plastic cable gland with bayonet locking, for housing series D, size M25, cable diameter: 9 ... 17 mm.

Contact insert - HC-A16-I-UT-M - 1585317



HEAVYCON pin insert, A16 series, 16-pos., screw connection

Contact insert - HC-A16-I-UT-F - 1585320



HEAVYCON female insert, A16 series, 16-pos., screw connection

Classifications

eCl@ss

| | |
|---------------|----------|
| eCl@ss 10.0.1 | 27440101 |
| eCl@ss 4.0 | 27260700 |
| eCl@ss 4.1 | 27260700 |
| eCl@ss 5.0 | 27260700 |
| eCl@ss 5.1 | 27260700 |
| eCl@ss 6.0 | 27260700 |
| eCl@ss 7.0 | 27440101 |
| eCl@ss 8.0 | 27440101 |
| eCl@ss 9.0 | 27440101 |

Connector set - HC-EVO-A16UT-BWSC-HH-M25-PLRBK - 1411359

Classifications

ETIM

| | |
|----------|----------|
| ETIM 4.0 | EC002641 |
| ETIM 5.0 | EC002636 |
| ETIM 6.0 | EC002636 |
| ETIM 7.0 | EC002636 |

UNSPSC

| | |
|-------------|----------|
| UNSPSC 13.2 | 39121409 |
| UNSPSC 18.0 | 39121409 |
| UNSPSC 19.0 | 39121409 |
| UNSPSC 20.0 | 39121409 |
| UNSPSC 21.0 | 39121409 |

Approvals

Approvals

Approvals

EAC / DNV GL / EAC

Ex Approvals

Approval details

| | | |
|-----|---|--------------------------|
| EAC |  | RU C- DE.AI30.B.01102 |
|-----|---|--------------------------|

| | | | |
|--------|---|---|------------|
| DNV GL |  | https://approvalfinder.dnvgl.com/ | TAE000037S |
|--------|---|---|------------|

| | | |
|-----|---|--------------------------|
| EAC |  | RU C- DE.BL08.B.00511 |
|-----|---|--------------------------|

Phoenix Contact 2020 © - all rights reserved
<http://www.phoenixcontact.com>

PHOENIX CONTACT GmbH & Co. KG
Flachmarktstr. 8
32825 Blomberg
Germany
Tel. +49 5235 300
Fax +49 5235 3 41200
<http://www.phoenixcontact.com>

X-ON Electronics

Largest Supplier of Electrical and Electronic Components

Click to view similar products for [Heavy Duty Power Connectors](#) category:

Click to view products by [Phoenix Contact](#) manufacturer:

Other Similar products are found below :

[647757-1](#) [6643411-1](#) [6646058-2](#) [6646137-1](#) [6646138-1](#) [6646479-1](#) [6646608-1](#) [6646786-1](#) [6646940-1](#) [6651091-1](#) [6651525-1](#) [6651529-1](#)
[6651788-1](#) [696475-1](#) [702-32-01109](#) [703-25-02205](#) [73000005059](#) [73000005642](#) [73080965046](#) [765-15-0080A](#) [765-16-0080B](#) [765-18-0080D](#)
[829992-1](#) [902-77-02113](#) [PS00/A0620/6300](#) [129-1J](#) [1409400](#) [AN0024023](#) [E6374G1](#) [e6389g2](#) [157-43GW8](#) [MS3117-14AC](#) [1643543-1](#)
[1650540-1](#) [1651811-2](#) [1766260-1](#) [1766282-1](#) [1766966-1](#) [1791340000](#) [NLDFT-3-BL-L-S120-M40A](#) [NLDFT-N-W-L-C240-M40B](#) [NLS-2-R-](#)
[C240-M40B](#) [NLS-N-W-C240-M40B](#) [NPS-3-BL-T6](#) [1986615-1](#) [2-1589900-8](#) [2199314-1](#) [KA8102](#) [9300480317](#) [SBS50BRN#6](#)