

# Cable gland - HC-B-G-M32-ER-AL - 1411444

Please be informed that the data shown in this PDF Document is generated from our Online Catalog. Please find the complete data in the user's documentation. Our General Terms of Use for Downloads are valid (<http://phoenixcontact.com/download>)



EVO metal cable gland with bayonet locking, B series, size M32, cable diameter: 14 - 21 mm



## Key Commercial Data

Packing unit	1 pc
GTIN	 4 046356 932431
GTIN	4046356932431

## Technical data

### Dimensions

Wrench size, union nut	34 mm
External cable diameter	14 mm ... 21 mm

### Ambient conditions

Degree of protection (IP)	IP66
	IP67
Degree of protection (NEMA)	4 (UL 50e)
	4X (UL 50e)
	12 (UL 50e)
Ambient temperature (operation)	-40 °C ... 125 °C (static)

### General

Type of the screw connection	M32
No. of conductors	1
Material	Die-cast aluminum, corrosion-resistant
Housing material	Die-cast aluminum, corrosion resistant
Cable gland material	Aluminum
Material, pressure screw	Nickel-plated brass
Seal material	NBR

# Cable gland - HC-B-G-M32-ER-AL - 1411444

## Technical data

### General

Cable seal material	NBR
Sealing material	NBR (O-ring)
Shielded	no
Tightening torque, union nut	10.00 Nm
Color	silver

### Environmental Product Compliance

REACH SVHC	Lead 7439-92-1
China RoHS	Environmentally Friendly Use Period = 50 years
	For details about hazardous substances go to tab "Downloads", Category "Manufacturer's declaration"

## Drawings

Dimensional drawing

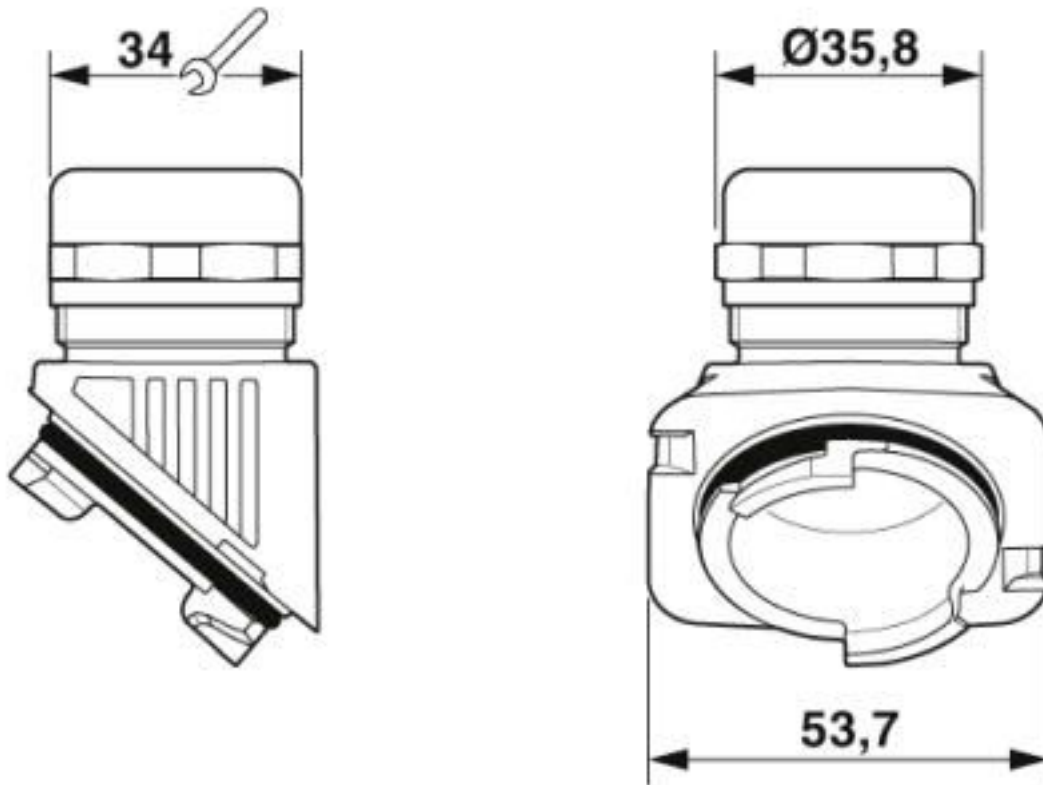

Dimensional drawing

# Cable gland - HC-B-G-M32-ER-AL - 1411444

## Classifications

### eCl@ss

eCl@ss 10.0.1	27144432
eCl@ss 4.0	27140800
eCl@ss 4.1	27140800
eCl@ss 5.0	27149100
eCl@ss 5.1	27143400
eCl@ss 6.0	27149100
eCl@ss 7.0	27149109
eCl@ss 8.0	27149109
eCl@ss 9.0	27144432

### ETIM

ETIM 4.0	EC000441
ETIM 5.0	EC000441
ETIM 6.0	EC000441
ETIM 7.0	EC000441

### UNSPSC

UNSPSC 13.2	39121311
UNSPSC 18.0	39121311
UNSPSC 19.0	39121311
UNSPSC 20.0	39121311
UNSPSC 21.0	39121311

## Approvals

### Approvals

---

#### Approvals

UL Recognized / cUL Recognized / DNV GL / EAC-RoHS / EAC / cULus Recognized

---

#### Ex Approvals





---

### Approval details

UL Recognized		<a href="http://database.ul.com/cgi-bin/XYV/template/LISEXT/1FRAME/index.htm">http://database.ul.com/cgi-bin/XYV/template/LISEXT/1FRAME/index.htm</a>	E255026
---------------	--	---	---------

## Cable gland - HC-B-G-M32-ER-AL - 1411444

### Approvals

cUL Recognized		<a href="http://database.ul.com/cgi-bin/XYV/template/LISEXT/1FRAME/index.htm">http://database.ul.com/cgi-bin/XYV/template/LISEXT/1FRAME/index.htm</a>	E255026
DNV GL		<a href="https://approvalfinder.dnvgl.com/">https://approvalfinder.dnvgl.com/</a>	TAE000037S
EAC-RoHS			RU D- DE.HB35.B.00387
EAC			RU C- DE.AI30.B.01102
cULus Recognized			

Phoenix Contact 2020 © - all rights reserved  
<http://www.phoenixcontact.com>

PHOENIX CONTACT GmbH & Co. KG  
Flachsmarktstr. 8  
32825 Blomberg  
Germany  
Tel. +49 5235 300  
Fax +49 5235 3 41200  
<http://www.phoenixcontact.com>

## X-ON Electronics

Largest Supplier of Electrical and Electronic Components

*Click to view similar products for [Heavy Duty Power Connectors](#) category:*

*Click to view products by [Phoenix Contact](#) manufacturer:*

Other Similar products are found below :

[647757-1](#) [6643411-1](#) [6646058-2](#) [6646137-1](#) [6646138-1](#) [6646479-1](#) [6646608-1](#) [6646786-1](#) [6646940-1](#) [6651091-1](#) [6651525-1](#) [6651529-1](#)  
[6651788-1](#) [696475-1](#) [702-32-01109](#) [703-25-02205](#) [73000005059](#) [73000005642](#) [73080965046](#) [765-15-0080A](#) [765-16-0080B](#) [765-18-0080D](#)  
[829992-1](#) [902-77-02113](#) [PS00/A0620/6300](#) [129-1J](#) [1409400](#) [AN0024023](#) [E6374G1](#) [e6389g2](#) [157-43GW8](#) [MS3117-14AC](#) [1643543-1](#)  
[1650540-1](#) [1651811-2](#) [1766260-1](#) [1766282-1](#) [1766966-1](#) [1791340000](#) [NLDFT-3-BL-L-S120-M40A](#) [NLDFT-N-W-L-C240-M40B](#) [NLS-2-R-](#)  
[C240-M40B](#) [NLS-N-W-C240-M40B](#) [NPS-3-BL-T6](#) [1986615-1](#) [2-1589900-8](#) [2199314-1](#) [KA8102](#) [9300480317](#) [SBS50BRN#6](#)