

## Network cable - NBC-MSD/10,0-93K/FSD SCO - 1411548

Please be informed that the data shown in this PDF Document is generated from our Online Catalog. Please find the complete data in the user's documentation. Our General Terms of Use for Downloads are valid (<http://phoenixcontact.com/download>)



Network cable, Sercos CAT5 (100 Mbps), 4-position, PVC/PVC, signal red RAL 3020, shielded, Plug straight M12 SPEEDCON / IP67, coding: D, on Socket straight M12 SPEEDCON / IP67, coding: D, cable length: 10 m



### Key Commercial Data

Packing unit	1 pc
GTIN	 4 046356 933872
GTIN	4046356933872

### Technical data

#### Dimensions

Length of cable	10 m
-----------------	------

#### Ambient conditions

Degree of protection	IP65 (M12 connector)
	IP67 (M12 connector)
Ambient temperature (operation)	-25 °C ... 85 °C (M12 connector)

#### General data

Rated current at 40°C	4 A
Rated voltage	48 V AC
	60 V DC
Number of positions	4
Signal type/category	Sercos CAT5 (IEC 11801), 100 Mbps
Standards/regulations	M12 connector IEC 61076-2-101
Degree of protection	IP65/IP67
Transmission characteristics (category)	CAT5

#### Characteristics head 1

Head type	Plug straight M12 SPEEDCON / IP67
-----------	-----------------------------------

# Network cable - NBC-MSD/10,0-93K/FSD SCO - 1411548

## Technical data

### Characteristics head 1

No. of positions (pin connector pattern)	4
Coding	D (Data)
Color	black
Material (component)	CuSn (Contact)
	Ni/Au (Contact surface)
	PA (Contact carriers)
	TPU, hardly inflammable, self-extinguishing (Grip)
	Zinc die-cast, nickel-plated (Screw connection)
Insulation resistance	≥ 100 MΩ
Insertion/withdrawal cycles	≥ 100
Torque	0.4 Nm
Ambient temperature (operation)	-25 °C ... 90 °C
Shielded	yes
Outer sheath, material	PVC
External sheath, color	signal red RAL 3020
Type type, plug side	Plug straight
Type type, socket side	Socket, straight

### Characteristics head 2

Head type	Socket straight M12 SPEEDCON / IP67
No. of positions (pin connector pattern)	4
Coding	D (Data)
Color	black
	black
Material (component)	CuSn (Contact)
	Ni/Au (Contact surface)
	TPU GF (Contact carriers)
	TPU, hardly inflammable, self-extinguishing (Grip)
	Zinc die-cast, nickel-plated (Screw connection)
Insulation resistance	≥ 100 MΩ
Insertion/withdrawal cycles	≥ 100
Torque	0.4 Nm
Ambient temperature (operation)	-25 °C ... 90 °C

### Standards and Regulations

Standards/specifications	M12 connector IEC 61076-2-101
--------------------------	-------------------------------

### Cable

Cable type	Sercos III
Cable type (abbreviation)	93K
UL AWM style	21694 (60°C / 600 V)
Signal type/category	Sercos CAT5 (IEC 11801), 100 Mbps

# Network cable - NBC-MSD/10,0-93K/FSD SCO - 1411548

## Technical data

### Cable

Cable structure	1x4xAWG22/7; SF/TQ
Conductor cross section	4x 0.34 mm <sup>2</sup>
AWG signal line	22
Conductor structure signal line	7x 0.25 mm
Core diameter including insulation	approx. 1.55 mm
Wire colors	White, yellow, blue, orange
Type of pair shielding	Aluminum-lined polyester foil
Overall twist	Star quad
Shielding	Tinned copper braided shield
External sheath, color	signal red RAL 3020
Outer sheath thickness	approx. 0.9 mm
External cable diameter D	6.5 mm ±0.2 mm
Minimum bending radius, fixed installation	3 x D
Minimum bending radius, flexible installation	7 x D
Cable weight	68 kg/km
Outer sheath, material	PVC
Material, inner sheath	PVC
Material conductor insulation	PE
Conductor material	Tin-plated Cu litz wires
Insulation resistance	≥ 0.5 GΩ*km
Conductor resistance	≤ 120 Ω/km
Wave impedance	100 Ω ±15 Ω (at 100 MHz)
Signal runtime	5.3 ns/m
Coupling resistance	≤ 20.00 mΩ/m (at 10 Hz)
Nominal voltage, cable	600 V
Test voltage Core/Core	2000 V (50 Hz, 1 min.)
Test voltage Core/Shield	2000 V (50 Hz, 1 min.)
Flame resistance	according to UL 1685 (CSA FT 4)
Resistance to oil	Resistant to oil to a limited extent
Other resistance	UV resistant According to UL 1581, Section 1200
Ambient temperature (operation)	-40 °C ... 70 °C (cable, fixed installation)
	-40 °C ... 70 °C (cable, flexible installation)
Ambient temperature (installation)	-20 °C ... 60 °C
Ambient temperature (storage/transport)	-50 °C ... 70 °C

### Environmental Product Compliance

REACH SVHC	Lead 7439-92-1
China RoHS	Environmentally Friendly Use Period = 50 years
	For details about hazardous substances go to tab "Downloads", Category "Manufacturer's declaration"

# Network cable - NBC-MSD/10,0-93K/FSD SCO - 1411548

## Drawings

Dimensional drawing

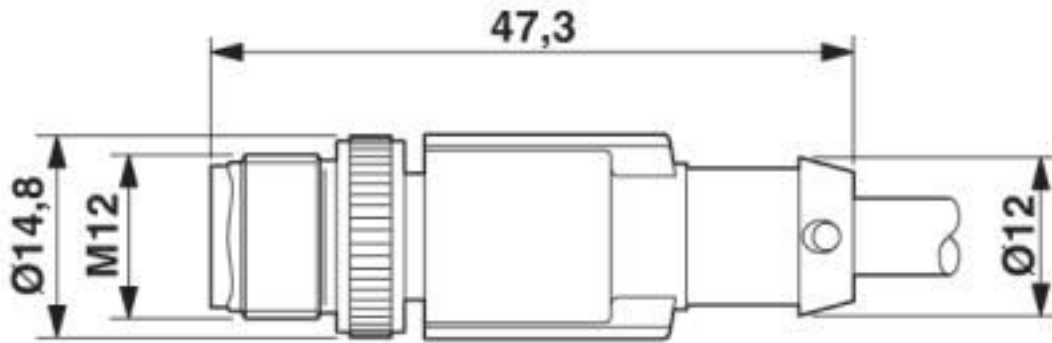

Plug, M12 x 1, straight, shielded

Dimensional drawing

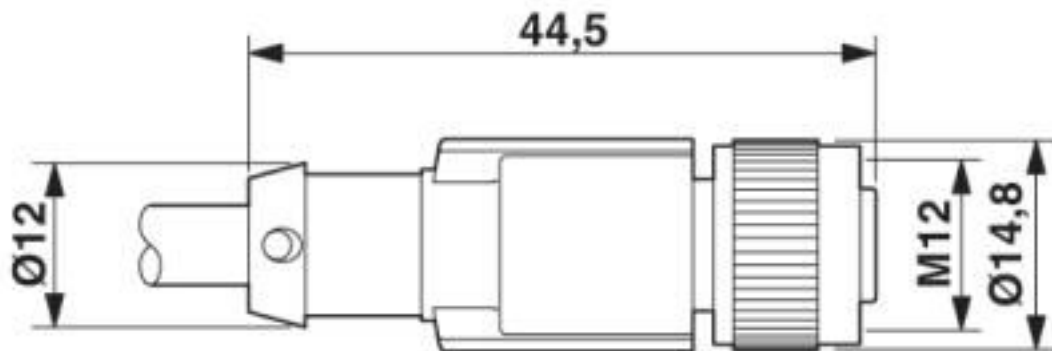

M12 x 1 socket, straight, shielded

Circuit diagram

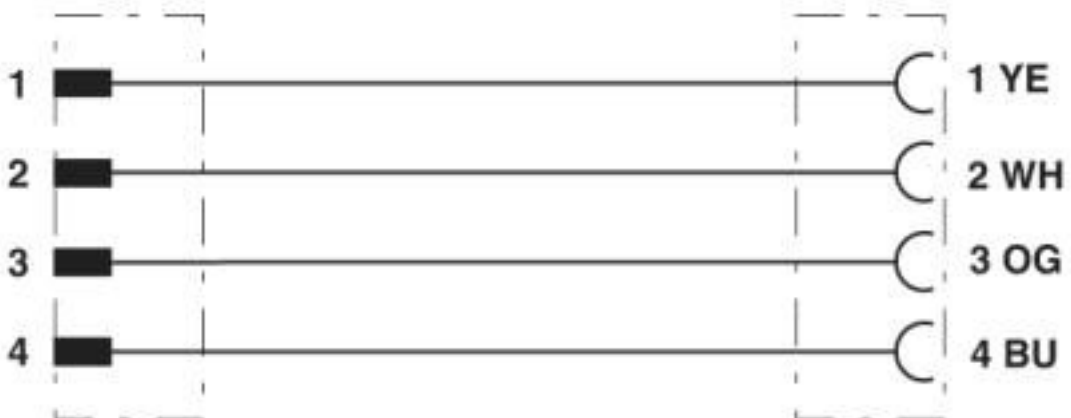

Contact assignment of the M12 connector and the M12 socket

# Network cable - NBC-MSD/10,0-93K/FSD SCO - 1411548

Schematic diagram

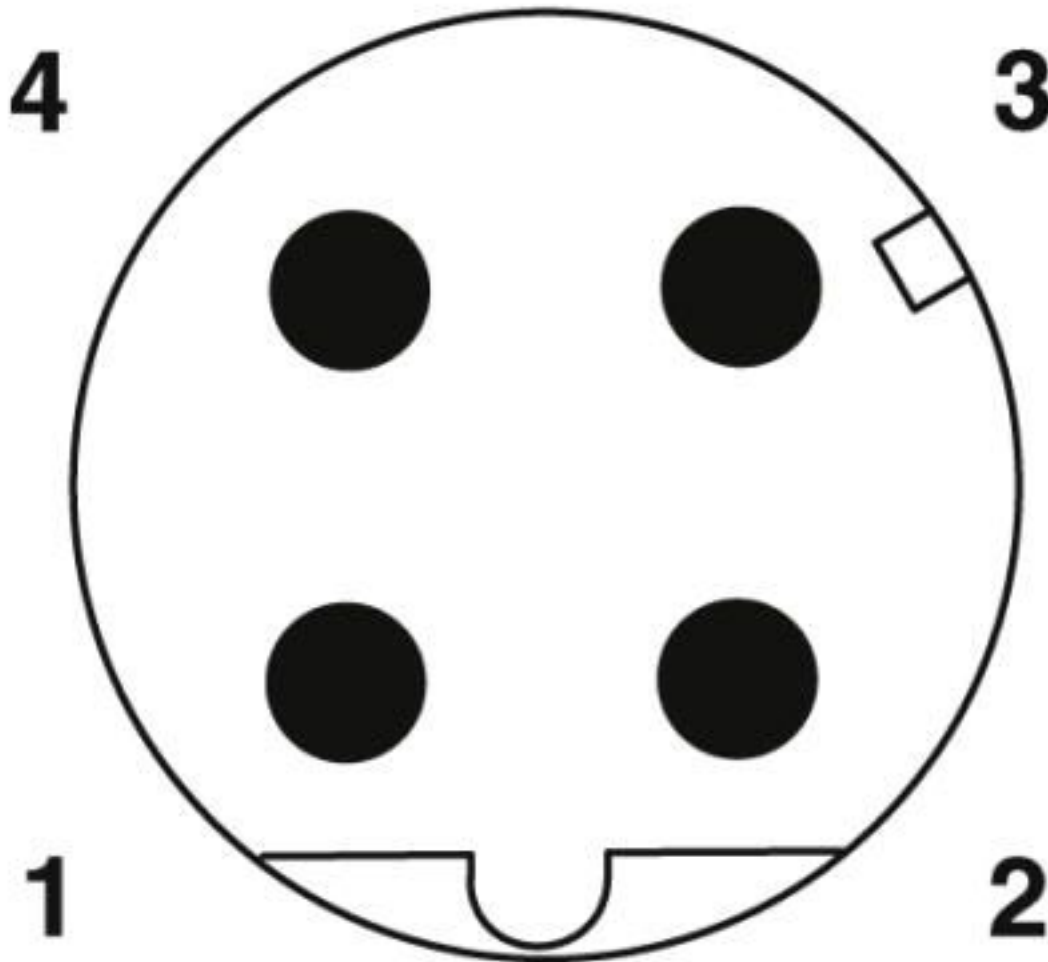

Pin assignment M12 male connector, 4-pos., D-coded, male side

## Network cable - NBC-MSD/10,0-93K/FSD SCO - 1411548

Schematic diagram

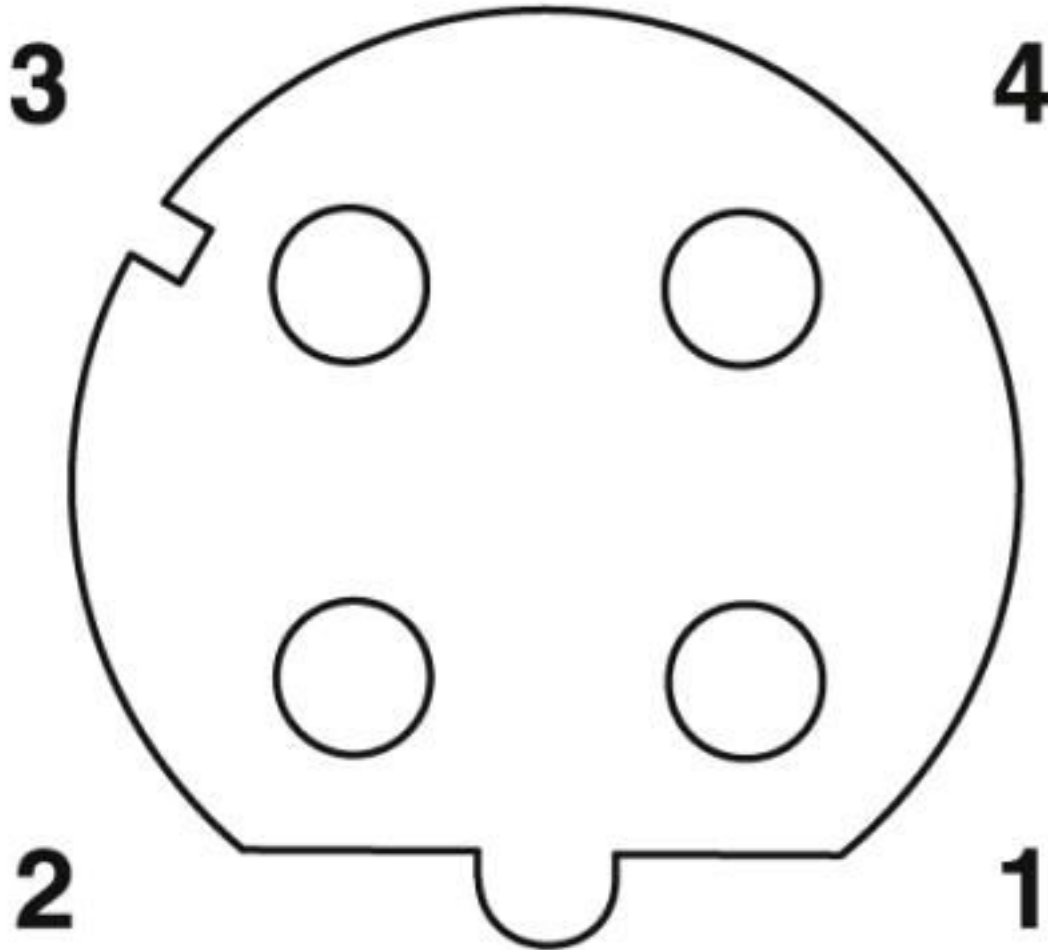

Pin assignment M12 socket, 4-pos., D-coded, female side

# Network cable - NBC-MSD/10,0-93K/FSD SCO - 1411548

Cable cross section

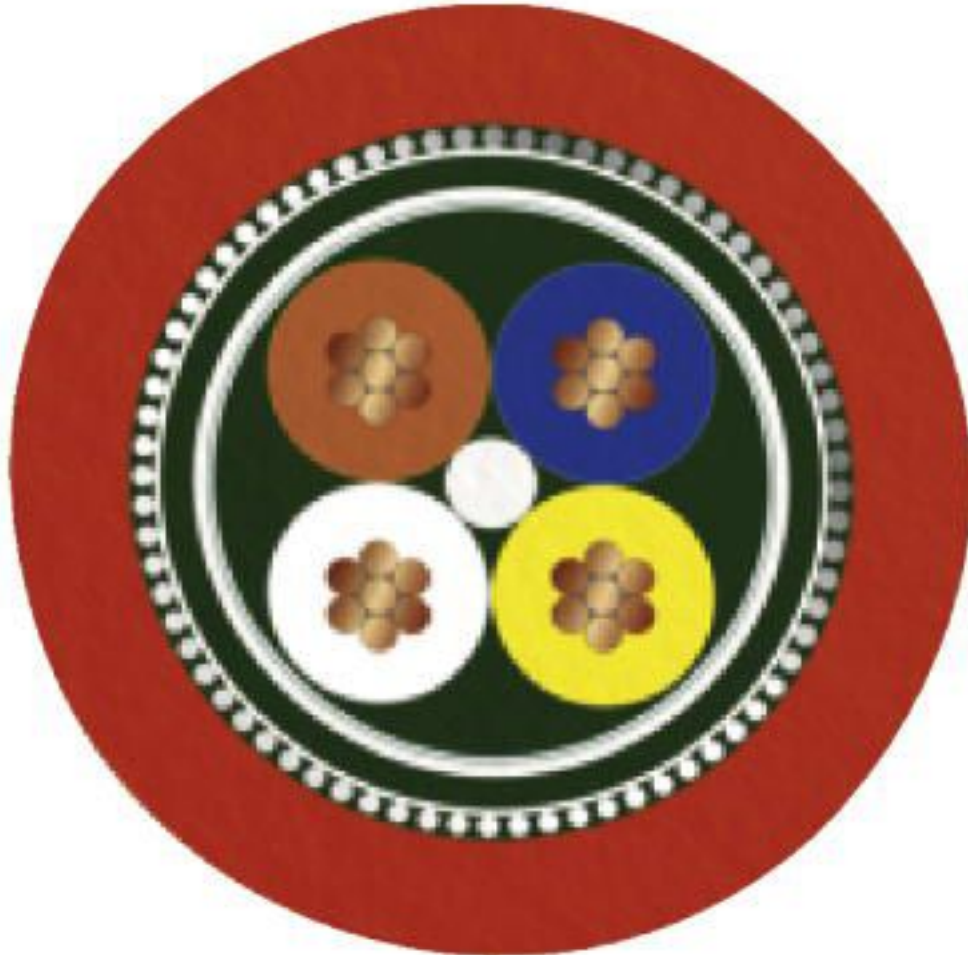

Sercos III [93K]

## Classifications

eCl@ss

eCl@ss 10.0.1	27060308
eCl@ss 4.0	27060300
eCl@ss 4.1	27060300
eCl@ss 5.0	27060300
eCl@ss 5.1	27060300
eCl@ss 6.0	27279200
eCl@ss 7.0	27279218
eCl@ss 8.0	27279218
eCl@ss 9.0	27060308

# Network cable - NBC-MSD/10,0-93K/FSD SCO - 1411548

## Classifications

### ETIM

ETIM 4.0	EC002599
ETIM 5.0	EC002599
ETIM 6.0	EC001262
ETIM 7.0	EC001262

### UNSPSC

UNSPSC 13.2	31251501
UNSPSC 18.0	26121604
UNSPSC 19.0	26121604
UNSPSC 20.0	26121604
UNSPSC 21.0	26121604

## Approvals

### Approvals

---

Approvals

EAC-RoHS

---

Ex Approvals

---

### Approval details

EAC-RoHS		RU D- DE.HB35.B.00387
----------	--	--------------------------

## Accessories

### Accessories

Plug for cable screw gland

Screw plug - PROT-M12 MS-PA-CHAIN - 1430899

M12 sealing cap with fixing band, for sensor cables, for free M12 sockets



Protective cap



## Network cable - NBC-MSD/10,0-93K/FSD SCO - 1411548

### Accessories

Sealing cap - PROT-M12 FS-PA-CHAIN - 1430873

M12 sealing cap made of plastic with fixing band, for sensor cables, for free M12 plugs



---

### Safety locking

Locking clip - SAC-M12-EXCLIP-M - 1558988



Locking clip for the pin side of sensor/actuator cables with M12 connector and M12 connectors for assembly, for knurl diameter: 15 mm or for Allen key with a wrench size of 14 mm, prevents the disconnection of plug-in connections without tools

Locking clip - SAC-M12-EXCLIP-F - 1558991



Locking clip for the socket side of sensor/actuator cables with M12 connector and M12 connectors for assembly, for knurl diameter: 15 mm or for Allen key with a wrench size of 14 mm, prevents the disconnection of plug-in connections without tools

---

### Screwdriver tools

Adapter insert - TSD-M SAC-BIT ADAPTER - 1212600



Adapter bit for TSD-M...torque tools, E6.3-1/4" drive with 4 mm hexagon to accommodate SAC bits

Tool - SAC BIT M12-D15 - 1208432



Nut for assembling sensor/actuator cables with M12 connector and M12 connectors for assembly, with a knurl diameter of 15 mm, for 4 mm hexagonal drive

---

### Torque tool

## Network cable - NBC-MSD/10,0-93K/FSD SCO - 1411548

### Accessories

Torque screwdriver - TSD 04 SAC - 1208429



Torque screwdriver, with preset torque of 0.4 Nm and 4 mm hexagonal drive for M12 connectors

---

Torque screwdriver - TSD-M 1,2NM - 1212224



Torque screw driver, accuracy as per EN ISO 6789 standard, adjustable from 0.3 - 1.2 Nm

---

---

Phoenix Contact 2020 © - all rights reserved  
<http://www.phoenixcontact.com>

PHOENIX CONTACT GmbH & Co. KG  
Flachsmarktstr. 8  
32825 Blomberg  
Germany  
Tel. +49 5235 300  
Fax +49 5235 3 41200  
<http://www.phoenixcontact.com>

## X-ON Electronics

Largest Supplier of Electrical and Electronic Components

*Click to view similar products for [Ethernet Cables / Networking Cables](#) category:*

*Click to view products by [Phoenix Contact](#) manufacturer:*

Other Similar products are found below :

[73-6670-7](#) [73-6680-15](#) [73-7797-25](#) [MCJB2-10P6Q7-120](#) [84909-0204](#) [1200700174](#) [1200860368](#) [E16A06002M030](#) [E200102-009-S1](#)  
[AX105346-EW](#) [MT14-187L](#) [17-103530](#) [ERWPAB3002M005](#) [190-038045-01](#) [NK5EPC18RDY](#) [NK5EPC18VLY](#) [NK5EPC18YLY](#)  
[NK5EPC1GRY](#) [NK5EPC4Y](#) [NK5EPC6YLY](#) [NK5EPC8BLY](#) [NK5EPC9YLY](#) [1969343-6](#) [C501100010](#) [C501106002](#) [C501106007](#)  
[C501106015](#) [C501106025](#) [C601102010](#) [C601104010](#) [C601106007](#) [C601106015](#) [2142758-2](#) [2168427-2](#) [CAT1106007](#) [21949-1](#) [2J1866A](#)  
[RJF SFTP 5E 0500](#) [AX100351](#) [MN14CEC/ST](#) [C501100015](#) [C501106004](#) [C501106010](#) [C5F1108007](#) [C601104004](#) [C601106004](#)  
[CA21106004](#) [CA21106010](#) [CA21106015](#) [CA21109007](#)