

Flush-type connector - SACC-E-M12MSS-3P-M16/0,5 PE - 1411655

Please be informed that the data shown in this PDF Document is generated from our Online Catalog. Please find the complete data in the user's documentation. Our General Terms of Use for Downloads are valid (<http://phoenixcontact.com/download>)



Flush-type connector, Power, 3-position, Plug, M12, S power, Front mounting, M16 x 1.5, Individual wires, cable length: 0.5 m, 1.31 mm², UL/cUL stranded hook-up wire

Your advantages

- ✓ For compact devices: transmit high power in a confined space
- ✓ For industrial infrastructure applications
- ✓ Protection against mismatching thanks to S-coding
- ✓ Pre-assembled with litz wires for immediate use
- ✓ Customer-specific assemblies and litz wire lengths available
- ✓ Sealed on the litz wire side for optimum leak-tightness
- ✓ For high transmission safety: shield connection to the housing with optional EMC nut



Key Commercial Data

Packing unit	1 pc
GTIN	 4 046356 936705
GTIN	4046356936705

Technical data

Dimensions

Length of cable	0.5 m
-----------------	-------

Ambient conditions

Ambient temperature (operation)	-25 °C ... 85 °C (Plug / socket)
Degree of protection	IP67

General

Note	The electrical and mechanical data specified assume that the connector pair is correctly locked and mounted. If the connector is unlocked and if there is a danger of contamination, the connector must be sealed using a protective cap > IP54. Influences arising from litz wires, cables or PCB assembly must also be taken into consideration.
------	--

Flush-type connector - SACC-E-M12MSS-3P-M16/0,5 PE - 1411655

Technical data

General

Rated current at 40°C	16 A
Rated voltage	630 V
Rated surge voltage	6 kV
Number of positions	3
Insulation resistance	≥ 100 MΩ
Coding	S power
Standards/regulations	M12 connector IEC 61076-2-111 In line with
Signal type/category	Power
Status display	No
Overvoltage category	III
Degree of pollution	3
Test voltage	6 kV
Connection method	Individual wires
Insertion/withdrawal cycles	> 100
Torque	3 Nm ... 4 Nm (M12 connector)
Mounting type	Front mounting M16 x 1.5

Material

Flammability rating according to UL 94	V0
Contact material	CuZn
Contact surface material	Au
Contact carrier material	PA
Material, knurls	CuZn alloy, nickel-plated
Sealing material	FKM
Additional material specifications	PU 2K (Grout material)

Cable

Cable type	UL/cUL stranded hook-up wire
Conductor cross section	1.31 mm ²
AWG signal line	16
Core diameter including insulation	2.2 mm
Wire colors	black 1, black 2, green/yellow
Material conductor insulation	mPPE
Conductor material	Bare Cu litz wires
Standards/specifications	M12 connector IEC 61076-2-111 In line with
Flame resistance	in acc. to UL 1581 VW1
Halogen-free	yes
Ambient temperature (operation)	-40 °C ... 105 °C (cable, fixed installation)
	-20 °C ... 105 °C (cable, flexible installation)

Standards and Regulations

Standards/specifications	M12 connector IEC 61076-2-111 In line with
--------------------------	--

Flush-type connector - SACC-E-M12MSS-3P-M16/0,5 PE - 1411655

Technical data

Standards and Regulations

Flame resistance	in acc. to UL 1581 VW1
Halogen-free	yes
Flammability rating according to UL 94	V0
Safety note	WARNING: The connectors may not be plugged in or disconnected under load. Ignoring the warning or improper use may damage persons and/or property.
	<ul style="list-style-type: none"> • WARNING: Commission properly functioning products only. The products must be regularly inspected for damage. Decommission defective products immediately. Replace damaged products. Repairs are not possible.
	<ul style="list-style-type: none"> • WARNING: Only electrically qualified personnel may install and operate the product. They must observe the following safety notes. The qualified personnel must be familiar with the basics of electrical engineering. They must be able to recognize and prevent danger. The relevant symbol on the packaging indicates that only personnel familiar with electrical engineering are allowed to install and operate the product.
	<ul style="list-style-type: none"> • The products are suitable for applications in plant, controller, and electrical device engineering.
	<ul style="list-style-type: none"> • When operating the connectors in outdoor applications, they must be separately protected against environmental influences.
	<ul style="list-style-type: none"> • Assembled products may not be manipulated or improperly opened.
	<ul style="list-style-type: none"> • Only use mating connectors that are specified in the technical data of the standards listed (e.g. the ones listed in the product accessories online at phoenixcontact.com/products).
	<ul style="list-style-type: none"> • When using the product in direct connection with third-party manufacturers, the user is responsible.
	<ul style="list-style-type: none"> • For operating voltages > 50 V AC, conductive connector housings must be grounded
	<ul style="list-style-type: none"> • Ensure that when laying the cable, the tensile load on the connectors does not exceed the upper limit specified in the standards.
	<ul style="list-style-type: none"> • Observe the corresponding technical data. You will find information: <ul style="list-style-type: none"> o On the product o On the packing label o In the supplied documentation o Online at phoenixcontact.com/products under the product
	<ul style="list-style-type: none"> • Only use tools recommended by Phoenix Contact
	<ul style="list-style-type: none"> • Use a protective cap to protect connectors that are not in use. The suitable accessories are available online in the accessory section of the product at phoenixcontact.com/products
	<ul style="list-style-type: none"> • Ensure that the protective or functional ground has been properly connected.
	<ul style="list-style-type: none"> • VDE 0100/1.97 § 411.1.3.2 and DIN EN 60 204/11.98 § 14.1.3 are applicable when combining several circuits in a cable and/or connector
	<ul style="list-style-type: none"> • The connector warms up in normal operation. Depending on the ambient conditions, the surface of the connector can continue to warm up. In this case, the user is responsible for posting warnings (e.g. DIN EN ISO 13732-1:2008-12).

Environmental Product Compliance

REACH SVHC	Lead 7439-92-1
China RoHS	Environmentally Friendly Use Period = 50 years

Flush-type connector - SACC-E-M12MSS-3P-M16/0,5 PE - 1411655

Technical data

Environmental Product Compliance

	For details about hazardous substances go to tab "Downloads", Category "Manufacturer's declaration"
--	---

Drawings

Schematic diagram

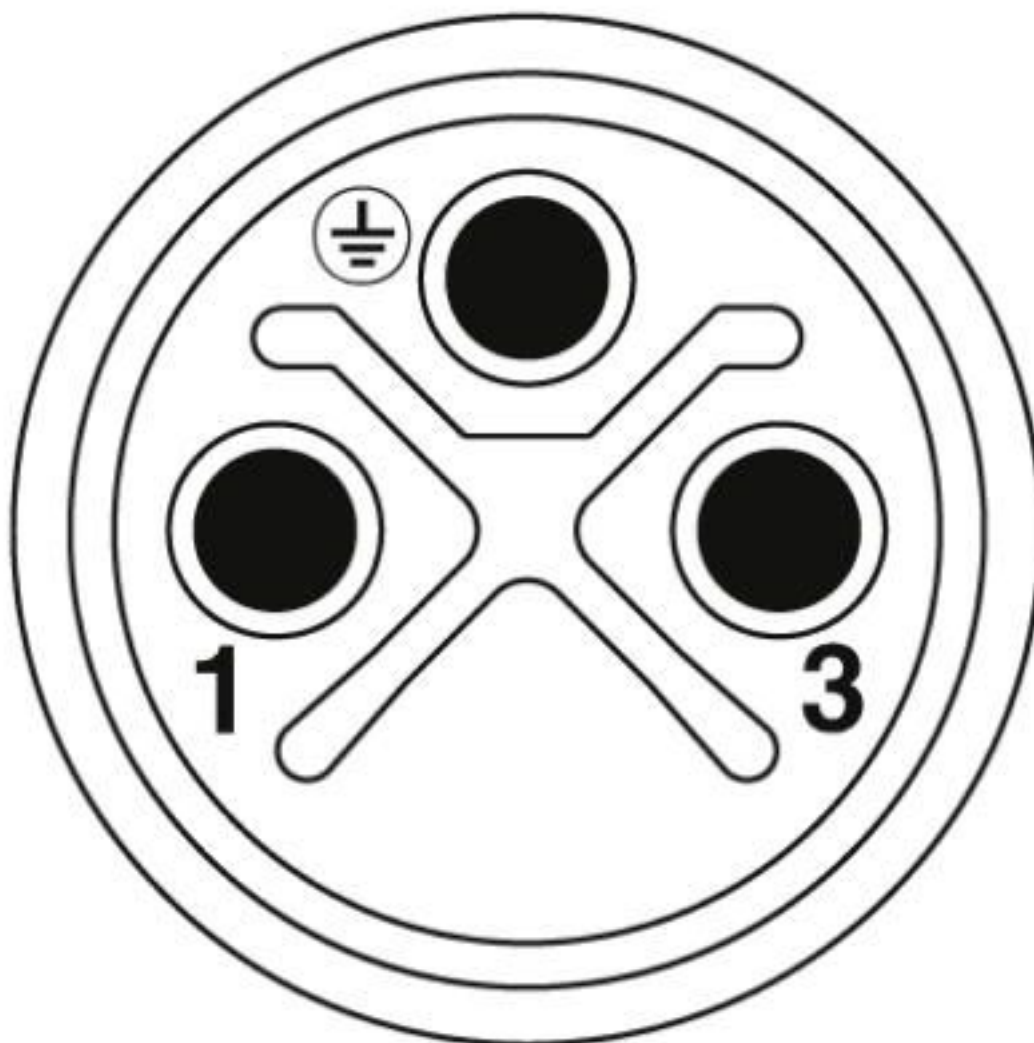

Pin assignment of M12 plug, 3-pos., S-coded, view of pin side

Flush-type connector - SACC-E-M12MSS-3P-M16/0,5 PE - 1411655

Diagram

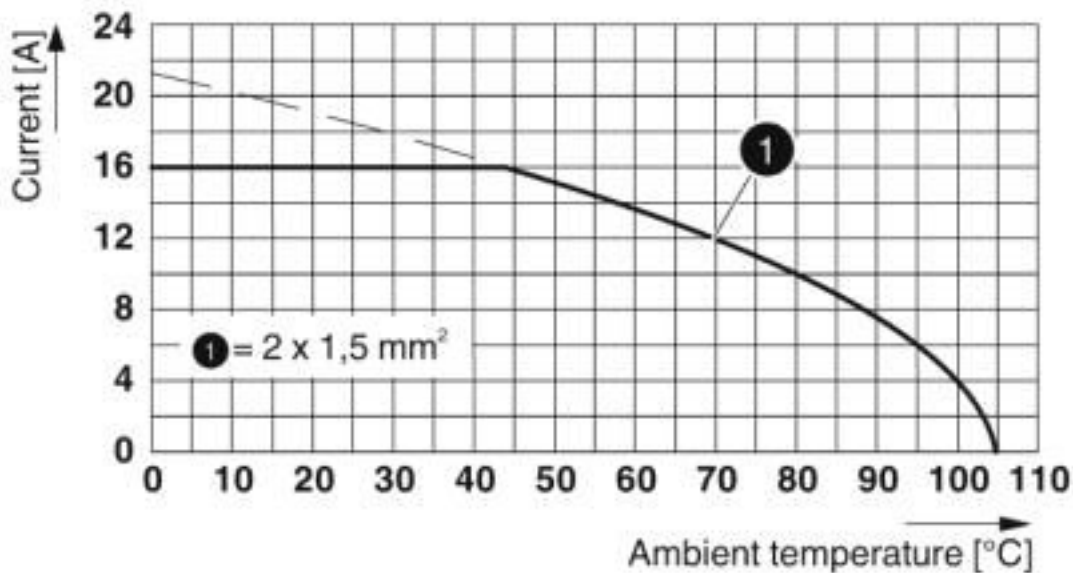

Derating diagram

Dimensional drawing

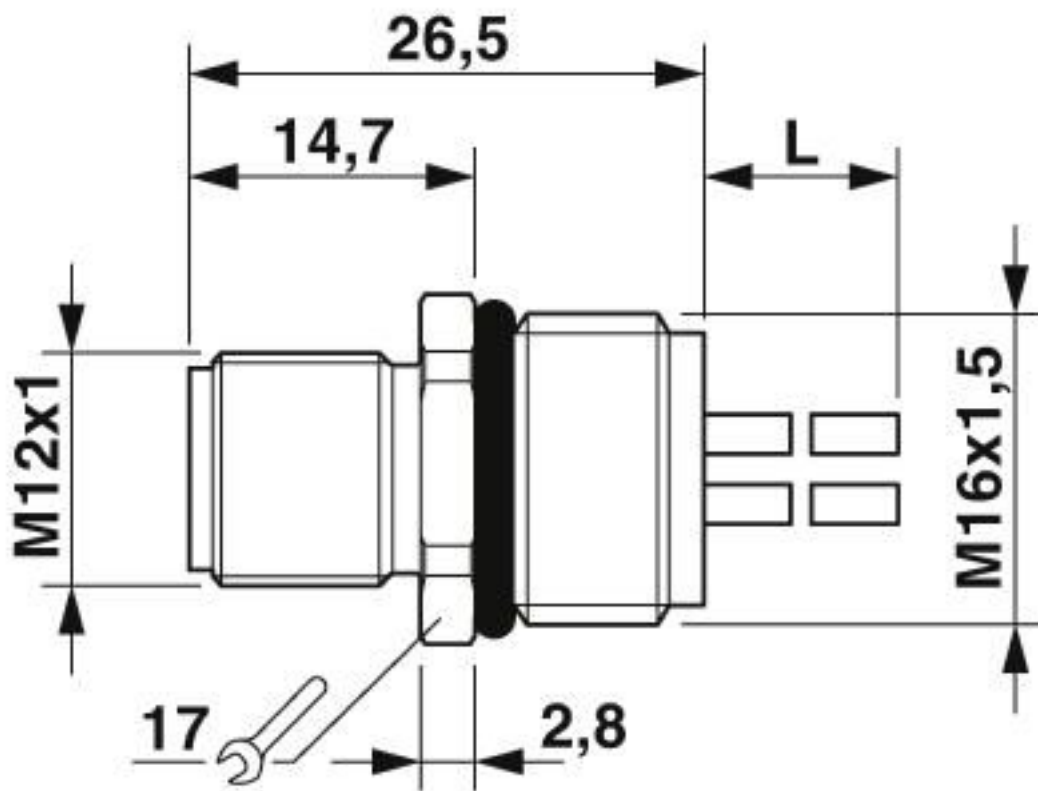

M12 flush-type plug

Flush-type connector - SACC-E-M12MSS-3P-M16/0,5 PE - 1411655

Circuit diagram

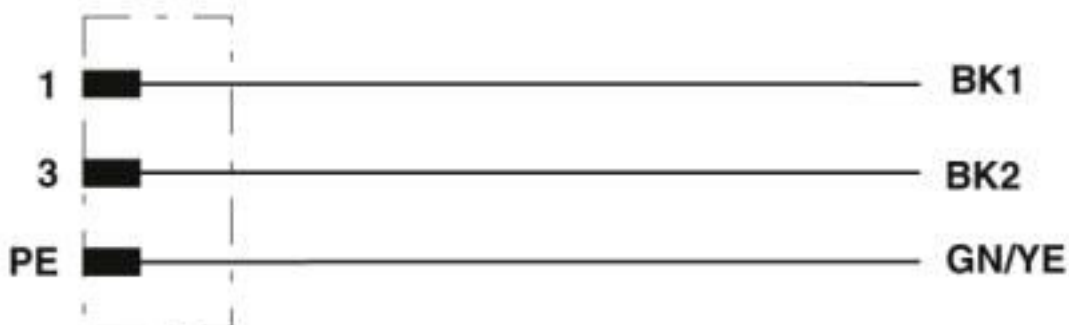

Contact assignment of the M12 plug

Classifications

eCl@ss

eCl@ss 10.0.1	27440102
eCl@ss 4.0	27140800
eCl@ss 4.1	27140800
eCl@ss 5.0	27143400
eCl@ss 5.1	27143400
eCl@ss 6.0	27279200
eCl@ss 7.0	27440103
eCl@ss 8.0	27440103
eCl@ss 9.0	27440102

ETIM

ETIM 4.0	EC002061
ETIM 5.0	EC002061
ETIM 6.0	EC002061

UNSPSC

UNSPSC 13.2	39121413
UNSPSC 18.0	39121413
UNSPSC 19.0	39121413
UNSPSC 20.0	39121413
UNSPSC 21.0	39121413

Approvals

Approvals

Approvals

EAC / cULus Recognized

Flush-type connector - SACC-E-M12MSS-3P-M16/0,5 PE - 1411655

Approvals

Ex Approvals

Approval details

EAC		B.01687
-----	---	---------

cULus Recognized	
------------------	---

Accessories

Accessories

Circular connectors (device side)

Flat nut - SACC-E-MU-M16 - 1504097



Flat nut with M16 thread

Phoenix Contact 2020 © - all rights reserved
<http://www.phoenixcontact.com>

PHOENIX CONTACT GmbH & Co. KG
Flachsmarktstr. 8
32825 Blomberg
Germany
Tel. +49 5235 300
Fax +49 5235 3 41200
<http://www.phoenixcontact.com>

X-ON Electronics

Largest Supplier of Electrical and Electronic Components

Click to view similar products for [Specialised Cables](#) category:

Click to view products by [Phoenix Contact](#) manufacturer:

Other Similar products are found below :

[603PT6](#) [603SS6L](#) [604PT6](#) [604SS6](#) [706000D02F200](#) [910640](#) [1200740077](#) [1200740114](#) [AC172](#) [ACL-SSI-4](#) [R88ACAKA0015SRE](#)
[R88ACAWL005SDE](#) [R88ACRGD0R3C](#) [1300150047](#) [1300660036](#) [1302262116](#) [1300150149](#) [1300220020](#) [1300220104](#) [1300220119](#)
[1301240492](#) [1301810221](#) [1365323-1](#) [1613055](#) [176P12](#) [1971465-2](#) [20240400003](#) [20240400013](#) [2085828-1](#) [20886510030](#) [2-22733-8](#) [22733-](#)
[8](#) [CB-5PSBC-RS](#) [CB-704EC-RS](#) [CB-BATACC-RS](#) [CB-JST3PSW-RS](#) [CB-M12COM-R10](#) [25AC84](#) [25AK84X](#) [25AU25](#) [25FN82](#) [3011-03](#)
[AC118](#) [ACL-HHS-1M\(CAT5E\)](#) [SSL009PC2DC012N](#) [FC2A-KC6C](#) [2085828-2](#) [20886510150](#) [CCS-FCB-5](#) [CCSFCBF2](#)