

Housing - HC-STA-B24-CHWS-1TTM40-ELC-AL - 1412747

Please be informed that the data shown in this PDF Document is generated from our Online Catalog. Please find the complete data in the user's documentation. Our General Terms of Use for Downloads are valid (<http://phoenixcontact.com/download>)



Coupling housings B24, with single locking latch, material: Die-cast aluminum, salt water resistant, cable outlets: 1, straight, height: 77 mm, cable gland: none, support sleeve: no, 1x M40, Standard

Your advantages

- ☑ good shielding in the event of electromagnetic interference



Key Commercial Data

Packing unit	1 pc
GTIN	 4 055626 058993
GTIN	4055626058993

Technical data

Dimensions

Height	77 mm
Width	44 mm
Length	120 mm

Ambient conditions

Degree of protection (IP)	IP66
	IP67
Degree of protection (NEMA)	4 (UL 50e)
	4X (UL 50e)
	12 (UL 50e)
Ambient temperature (operation)	-40 °C ... 125 °C

General

Note	for contact inserts HC-B24, BB46, D64, DD108, HV10/16, M
Size	B24
Housing type	Coupling housings

Housing - HC-STA-B24-CHWS-1TTM40-ELC-AL - 1412747

Technical data

General

Color	gray aluminum
Locking type	with single locking latch
No. of cable outlets	1
Cable outlet	straight
Screw connection	none
Type of the screw connection	1x M40
Housing material	Die-cast aluminum, salt water resistant
Housing surface material	uncoated
Seal material	NBR, conductive
Material lock	PA
Flammability rating according to UL 94	V0 (Interlock)

Environmental Product Compliance

China RoHS	Environmentally Friendly Use Period = 50 years
	For details about hazardous substances go to tab "Downloads", Category "Manufacturer's declaration"

Drawings

Dimensional drawing

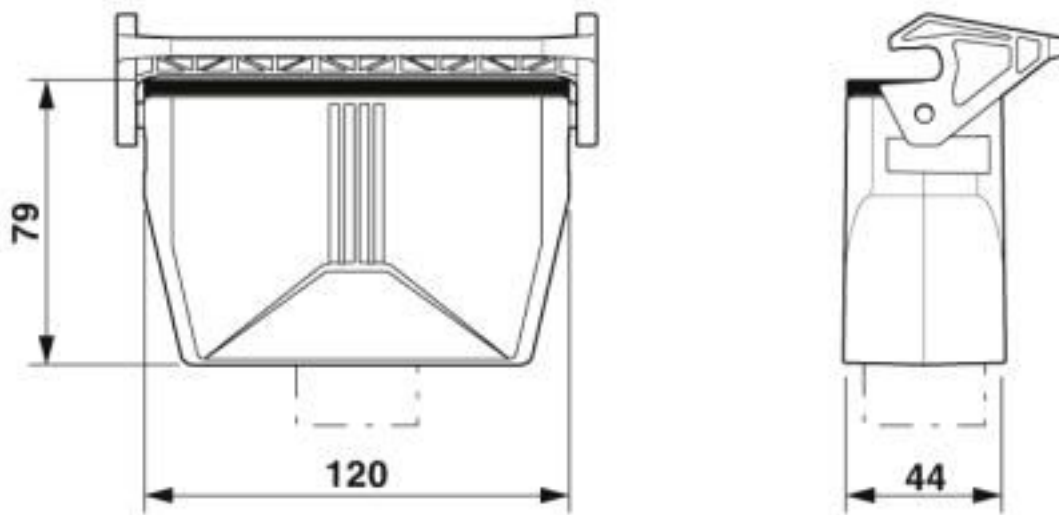

Dimensional drawing

Classifications

eCl@ss

eCl@ss 10.0.1	27440202
eCl@ss 5.1	27261200
eCl@ss 6.0	27261200

Housing - HC-STA-B24-CHWS-1TTM40-ELC-AL - 1412747

Classifications

eCl@ss

eCl@ss 7.0	27440202
eCl@ss 8.0	27440202
eCl@ss 9.0	27440202

ETIM

ETIM 5.0	EC000437
ETIM 6.0	EC000437
ETIM 7.0	EC000437

UNSPSC

UNSPSC 13.2	31261501
UNSPSC 18.0	31261501
UNSPSC 19.0	31261501
UNSPSC 20.0	31261501
UNSPSC 21.0	31261501

Approvals

Approvals

Approvals

UL Recognized / cUL Recognized / EAC / DNV GL / cULus Recognized

Ex Approvals

Approval details

UL Recognized		http://database.ul.com/cgi-bin/XYV/template/LISEXT/1FRAME/index.htm	E255026
---------------	---	---	---------

cUL Recognized		http://database.ul.com/cgi-bin/XYV/template/LISEXT/1FRAME/index.htm	E255026
----------------	---	---	---------

EAC		RU C- DE.AI30.B.01102
-----	---	--------------------------

Housing - HC-STA-B24-CHWS-1TTM40-ELC-AL - 1412747

Approvals

DNV GL		https://approvalfinder.dnvgl.com/	TAE000037S
--------	--	---	------------

cULus Recognized	
------------------	--

Accessories

Accessories

Full screw connection

Cable gland - G-INS-M40-M68N-NNES-S - 1411167



Cable gland, cable gland material: Nickel-plated brass, external cable diameter 19 mm ... 28 mm, shielding: no, connecting thread: M40 x 1.5, color: silver, with O-ring

Cable gland - G-INSEC-M40-M68N-NCRS-S - 1411192



Cable gland, cable gland material: Nickel-plated brass, external cable diameter 19 mm ... 27 mm, shielding: yes, connecting thread: M40 x 1.5, color: silver, with O-ring

Housing latches

Replacement part - HC-STA-B24-SL-PLBK - 1412885



Single locking latch for B24 housing, HC-EVO....AL and HC-STA....AL

Labeled device marker

Housing - HC-STA-B24-CHWS-1TTM40-ELC-AL - 1412747

Accessories

Plastic label - US-EMLP (20X9) CUS - 0830085



Plastic label, can be ordered: by card, white, labeled according to customer specifications, mounting type: adhesive, lettering field size: 20 x 9 mm, Number of individual labels: 75

Seal

Profile gasket - HC-B24-SP-CBK - 1411482



Profile gasket for HEAVYCON EVO supporting base element type B24, conductive

Phoenix Contact 2020 © - all rights reserved
<http://www.phoenixcontact.com>

PHOENIX CONTACT GmbH & Co. KG
Flachsmarktstr. 8
32825 Blomberg
Germany
Tel. +49 5235 300
Fax +49 5235 3 41200
<http://www.phoenixcontact.com>

X-ON Electronics

Largest Supplier of Electrical and Electronic Components

Click to view similar products for [Heavy Duty Power Connectors](#) category:

Click to view products by [Phoenix Contact](#) manufacturer:

Other Similar products are found below :

[647757-1](#) [6643411-1](#) [6646058-2](#) [6646137-1](#) [6646138-1](#) [6646479-1](#) [6646608-1](#) [6646786-1](#) [6646940-1](#) [6651091-1](#) [6651525-1](#) [6651529-1](#)
[6651788-1](#) [696475-1](#) [702-32-01109](#) [703-25-02205](#) [73000005059](#) [73000005642](#) [765-15-0080A](#) [765-16-0080B](#) [765-18-0080D](#) [829992-1](#)
[902-77-02113](#) [PS00/A0620/6300](#) [129-1J](#) [1409400](#) [AN0024023](#) [E6374G1](#) [e6389g2](#) [157-43GW8](#) [MS3117-14AC](#) [1643543-1](#) [1650540-1](#)
[1651811-2](#) [1766260-1](#) [1766282-1](#) [1766966-1](#) [1791340000](#) [NLDFT-3-BL-L-S120-M40A](#) [NLDFT-N-W-L-C240-M40B](#) [NLS-2-R-C240-](#)
[M40B](#) [NLS-N-W-C240-M40B](#) [NPS-3-BL-T6](#) [1986615-1](#) [2-1589900-8](#) [2199314-1](#) [KA8102](#) [9300480317](#) [SBS50BRN#6](#) [29131](#)