

Cable gland - HC-B-GTRS-M40-ER-AL - 1414659

Please be informed that the data shown in this PDF Document is generated from our Online Catalog. Please find the complete data in the user's documentation. Our General Terms of Use for Downloads are valid (<http://phoenixcontact.com/download>)



Set consisting of: EVO metal adapter 1414259 and screw connection with terminal block 1415195, M40



COMPLIANT

Key Commercial Data

Packing unit	1 pc
GTIN	 4 055626 031101
GTIN	4055626031101

Technical data

Dimensions

Wrench size, union nut	46 mm
Wrench size, support	46 mm
External cable diameter	16 mm ... 28 mm

Ambient conditions

Degree of protection (IP)	IP66
	IP67
Ambient temperature (operation)	-40 °C ... 100 °C

General

Type of the screw connection	M40
Type	with external strain relief
No. of conductors	1
Cable gland material	Nickel-plated brass
Material, pressure screw	Nickel-plated brass
Sealing material	EPDM (Screw connection)
Shielded	no
Color	silver

Cable gland - HC-B-GTRS-M40-ER-AL - 1414659

Technical data

Environmental Product Compliance

REACH SVHC	Lead 7439-92-1
China RoHS	Environmentally Friendly Use Period = 50 years
	For details about hazardous substances go to tab "Downloads", Category "Manufacturer's declaration"

Drawings

Dimensional drawing

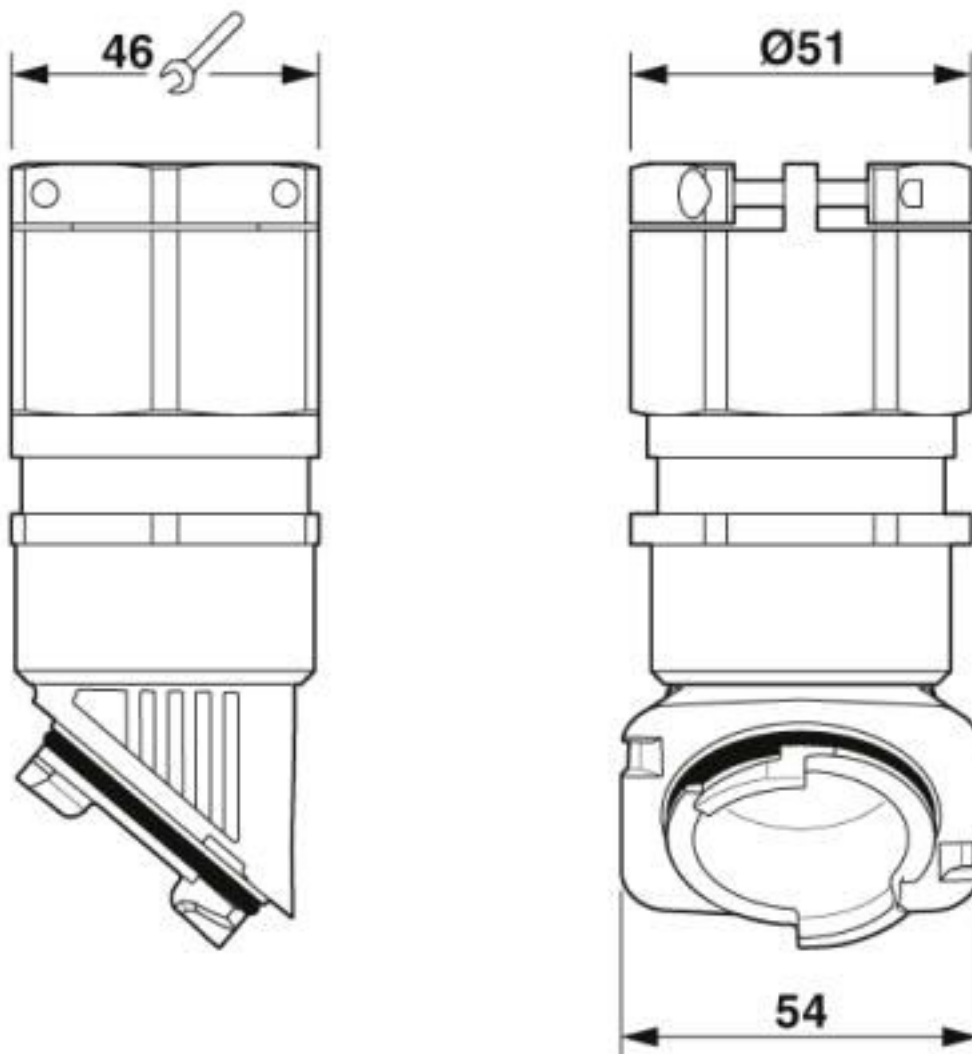

Dimensional drawing

Cable gland - HC-B-GTRS-M40-ER-AL - 1414659

Classifications

eCl@ss

eCl@ss 10.0.1	27144432
eCl@ss 4.0	27140800
eCl@ss 4.1	27140800
eCl@ss 5.0	27149100
eCl@ss 5.1	27143400
eCl@ss 6.0	27149100
eCl@ss 7.0	27149109
eCl@ss 8.0	27149109
eCl@ss 9.0	27144432

ETIM

ETIM 5.0	EC000441
ETIM 6.0	EC000441
ETIM 7.0	EC000441

UNSPSC

UNSPSC 13.2	39121311
UNSPSC 18.0	39121311
UNSPSC 19.0	39121311
UNSPSC 20.0	39121311
UNSPSC 21.0	39121311

Approvals

Approvals

Approvals

EAC-RoHS / EAC

Ex Approvals

Approval details

EAC-RoHS		RU D- DE.HB35.B.00387
----------	--	--------------------------

EAC		RU C- DE.AI30.B.01102
-----	--	--------------------------

Phoenix Contact 2020 © - all rights reserved
<http://www.phoenixcontact.com>

PHOENIX CONTACT GmbH & Co. KG
Flachsmarktstr. 8
32825 Blomberg
Germany
Tel. +49 5235 300
Fax +49 5235 3 41200
<http://www.phoenixcontact.com>

X-ON Electronics

Largest Supplier of Electrical and Electronic Components

Click to view similar products for [Cable Mounting & Accessories](#) category:

Click to view products by [Phoenix Contact](#) manufacturer:

Other Similar products are found below :

[582603-1](#) [009333-000](#) [727844N003](#) [747](#) [809090N001](#) [843188-000](#) [8666](#) [967279N002](#) [DB-11](#) [1300840039](#) [1300900096](#) [1301800416](#)
[1302264450](#) [1300830184](#) [1300830729](#) [1300900039](#) [1301580036](#) [1301850553](#) [1301860939](#) [1302000074](#) [1302261315](#) [1302264431](#)
[1337706-2](#) [APA18-AK](#) [1724](#) [1-787307-1](#) [185491N001](#) [1868](#) [HP-6N](#) [C-202-C](#) [202C221-13-0](#) [CA7308-000](#) [8S23-75FR-CS8184](#) [2684](#) [9648](#)
[3089](#) [988382-000](#) [A72821-000](#) [AA401](#) [173506-000](#) [1823](#) [202C292-13-0](#) [202C302-13-0](#) [2109](#) [300625](#) [3330](#) [3412](#) [356247-1](#) [M9142](#)
[M9143](#)