

T distributor - QPD T 2PE1,5 2X4-9 BK - 1414711

Please be informed that the data shown in this PDF Document is generated from our Online Catalog. Please find the complete data in the user's documentation. Our General Terms of Use for Downloads are valid (<http://phoenixcontact.com/download>)



T distributor, QUICKON connection, number of positions: 2+PE, 0.5 mm² ... 1.5 mm², 690 V, 17.5 A, black, With two QUICKON nuts, cable diameter range: 5 mm ... 9.5 mm

Your advantages

- ✓ Innovative and time saving - QUICKON fast connection for time saving of up to 80 % for on-site connection
- ✓ Convenient: quick and easy assembly without special tools
- ✓ Robust throughout: housing with IP68/IP69K and IK07 protection for a wide range of applications
- ✓ Safer connection thanks to polarization against mismatching and touch-proof protection according to DIN EN 0105
- ✓ Flexible and compact - by connecting connections internally, H and T-distributors can be used to branch master cables or they can be used as star distributors

Key Commercial Data

Packing unit	1 pc
GTIN	
GTIN	4055626032085

Technical data

General

Type	T-distributor
Color	black
Locking type	Screw locking
Connection method	QUICKON connection
	IDC connection
Number of positions	3
Note number of positions	2+PE
Tightening torque, union nut	8 Nm
Tightening torque, counter nut	5 Nm
Number of connections	2
Conductor cross section flexible min.	0.5 mm ²

T distributor - QPD T 2PE1,5 2X4-9 BK - 1414711

Technical data

General

Conductor cross section flexible max.	1.5 mm ²
Conductor cross section solid min.	0.5 mm ²
Conductor cross section solid max.	1.5 mm ²
Conductor cross section AWG min.	20
Conductor cross section AWG max.	16

Cabel

Structure of individual litz in acc. with VDE 0295 / smallest wire diameter	VDE 0295 class 1 to 6/min. 0.15 mm
Wire insulation material	PVC/PE/TPE/rubber
Wire diameter including insulation	1.6 mm ... 3 mm
External cable diameter	5 mm ... 9.5 mm
Position marking	1, 2, PE

Ambient conditions

Degree of protection	IP66
	IP68 (2 m / 24 h)
	IP69K (Distance from the nozzle 150 mm)
Ambient temperature (operation)	-40 °C ... 100 °C
Ambient temperature (storage/transport)	-40 °C ... 100 °C
Temperature when conductor connected	-5 °C ... 50 °C

Electrical characteristics

Nominal current I _N	17.5 A
Nominal voltage U _N	690 V AC
	690 V DC
Rated current	17.5 A
Rated voltage (III/3)	690 V
Rated voltage (III/2)	1000 V
Rated voltage (II/2)	1000 V
Rated surge voltage (III/3)	6 kV
Rated surge voltage (III/2)	8 kV
Rated surge voltage (II/2)	8 kV

Mechanical characteristics

QUICKON connectability	max. 10
Insertion/withdrawal cycles	10 (QUICKON connections max. 10)
Category of shock impact	IK07 (-25 °C)

Material data

Contact material	Cu
Contact surface material	silver-plated
Contact carrier material	PA
Insulating material	PA

T distributor - QPD T 2PE1,5 2X4-9 BK - 1414711

Technical data

Material data

Flammability rating according to UL 94	V0
Overvoltage category	III
Degree of pollution	3

Standards and Regulations

Category of shock impact	IK07 (-25 °C)
Flammability rating according to UL 94	V0

Environmental Product Compliance

REACH SVHC	Lead 7439-92-1
------------	----------------

Drawings

Dimensional drawing

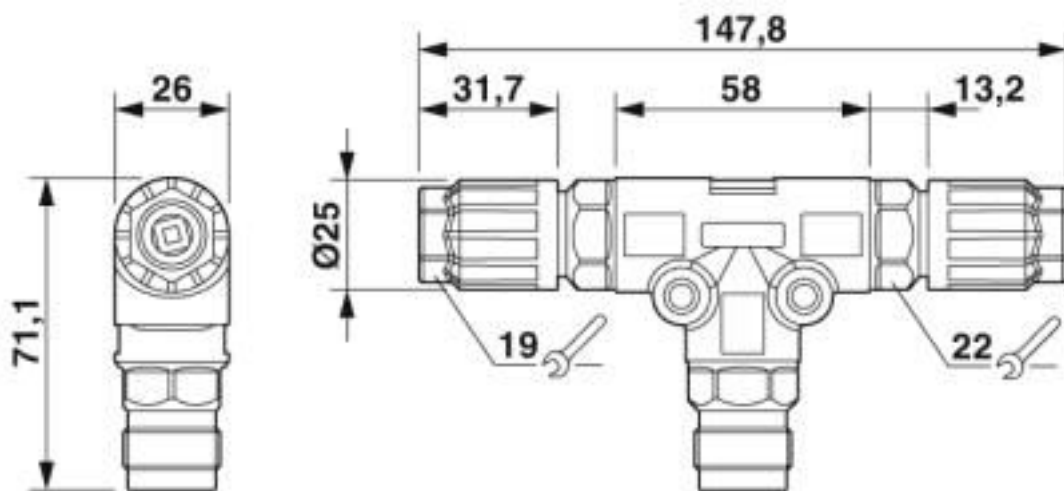

Dimensional drawing

T distributor - QPD T 2PE1,5 2X4-9 BK - 1414711

Circuit diagram

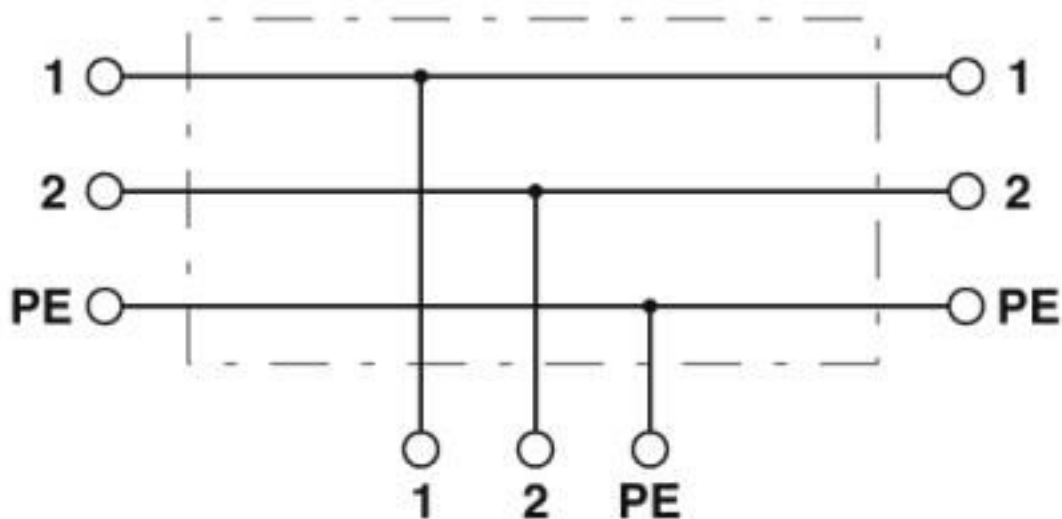

Classifications

eCl@ss

eCl@ss 10.0.1	27440603
eCl@ss 4.0	27140800
eCl@ss 4.1	27140800
eCl@ss 5.0	27143400
eCl@ss 5.1	27143400
eCl@ss 6.0	27143400
eCl@ss 7.0	27440603
eCl@ss 8.0	27440603
eCl@ss 9.0	27440603

ETIM

ETIM 5.0	EC002567
ETIM 6.0	EC002567
ETIM 7.0	EC002567

UNSPSC

UNSPSC 13.2	31251501
UNSPSC 18.0	39121410
UNSPSC 19.0	39121410
UNSPSC 20.0	39121410
UNSPSC 21.0	39121410

Approvals

Approvals

T distributor - QPD T 2PE1,5 2X4-9 BK - 1414711

Approvals

Approvals

EAC / EAC / DNV GL / IECEE CB Scheme / UL Listed / cUL Listed / VDE Zeichengenehmigung / cULus Listed

Ex Approvals

Approval details

EAC			RU C- DE.AI30.B.01102
-----	---	--	--------------------------

EAC			RU C- DE.BL08.B.00511
-----	---	--	--------------------------

DNV GL		https://approvalfinder.dnvgl.com/	TAE00003J5
--------	---	---	------------

IECEE CB Scheme		http://www.iecee.org/	DE1-61559
-----------------	---	---	-----------

UL Listed		http://database.ul.com/cgi-bin/XYV/template/LISEXT/1FRAME/index.htm	E468743
-----------	---	---	---------

Nominal voltage UN	600 V
Nominal current IN	8 A
mm ² /AWG/kcmil	16

cUL Listed		http://database.ul.com/cgi-bin/XYV/template/LISEXT/1FRAME/index.htm	E468743
------------	---	---	---------

Nominal voltage UN	600 V
Nominal current IN	8 A
mm ² /AWG/kcmil	16

T distributor - QPD T 2PE1,5 2X4-9 BK - 1414711

Approvals

VDE Zeichengenehmigung		http://www2.vde.com/de/Institut/Online-Service/VDE-gepruefteProdukte/Seiten/Online-Suche.aspx	40029149
Nominal voltage UN	690 V		
Nominal current IN	17.5 A		
mm ² /AWG/kcmil	0.5-1.5		

cULus Listed	
--------------	--

Accessories

Accessories

Coding element

Coding profile - CP-QPD 3/4X1,5 - 1414729



Coding profile red, for pushing into the QUICKON dome and connector, can be positioned in 90° steps.

Device marking

Engraving material - GPE 13X 9 WH - 0806932



Engraving material, Sheet, white, unlabeled, can be labeled with: PLOTMARK, ENGRAVING UNIT, CMS-P1-PLOTTER, P1 ENGRAVING UNIT, mounting type: adhesive, lettering field size: 13 x 9 mm, Number of individual labels: 120

Plastic label - EMLP (13X9)R - 0819453



Plastic label, Roll, white, unlabeled, can be labeled with: THERMOMARK ROLLMASTER 300/600, THERMOMARK X1.2, THERMOMARK ROLL X1, THERMOMARK ROLL 2.0, THERMOMARK ROLL, mounting type: adhesive, lettering field size: 13 x 9 mm, Number of individual labels: 500

Protective cap

T distributor - QPD T 2PE1,5 2X4-9 BK - 1414711

Accessories

Protective cap - QPD QSK BK 3/4X1,5 FS - 1414722

Protective cap, plastic, for QUICKON connection, black, with retaining cord, IP68



Protective cap - QPD QSK 3/4X1,5 - 1414723



Protective cap plastic, for QPD-QUICKON connection 3(4) x 1.5 mm², IP50

Sealing plugs

Closing cap - SEALING PLUG 7X16 RD - 1400255



Closing cap, material: PA, color: red

Phoenix Contact 2020 © - all rights reserved
<http://www.phoenixcontact.com>

PHOENIX CONTACT GmbH & Co. KG
Flachsmarktstr. 8
32825 Blomberg
Germany
Tel. +49 5235 300
Fax +49 5235 3 41200
<http://www.phoenixcontact.com>

X-ON Electronics

Largest Supplier of Electrical and Electronic Components

Click to view similar products for [Circular Metric Connectors](#) category:

Click to view products by [Phoenix Contact](#) manufacturer:

Other Similar products are found below :

[1424048](#) [1021212](#) [600X518037X](#) [6STD09SAM99B70X](#) [6STD15PCR99B70A](#) [8R4000A16M020](#) [1200910002](#) [1201150041](#) [1203580030](#)
[1200700064](#) [1200700263](#) [1200700416](#) [1200730102](#) [1200770002](#) [1-2823588-2](#) [130203-0054](#) [1300140026](#) [1300150099](#) [1-3637-600-5205](#)
[1545399](#) [1594331](#) [1600413](#) [1612606](#) [1612618](#) [1614660](#) [1A4000-348](#) [CA06EW24-10P-B-03](#) [21036836414](#) [2823064-1](#) [1610759](#) [A1642LK-](#)
[II-T](#) [1R3006A20M005](#) [41-01016](#) [41-40011](#) [41-40017](#) [42-00006](#) [42-01015](#) [4-22279-4](#) [4-22281-1](#) [4-22284-9](#) [43-00002](#) [43-00113](#) [43-00130](#)
[43-01028](#) [43-01034](#) [43-01088](#) [43-01090](#) [43-01203](#) [43-01209](#) [43-01335](#)