

Power cable - SAC-5P-M12MRK/ 3,0-PVC PE - 1414839

Please be informed that the data shown in this PDF Document is generated from our Online Catalog. Please find the complete data in the user's documentation. Our General Terms of Use for Downloads are valid (<http://phoenixcontact.com/download>)



Power cable, 5-position, PVC, black-gray RAL 7021, Plug angled M12, coding: K, on free cable end, cable length: 3 m, for AC current up to 16 A/690 V

Your advantages

- ✓ Easy and safe: 100% electrically tested plug-in components
- ✓ High-performance: AC connectors for up to 16 A and 690 V AC
- ✓ Protection against mismatching, thanks to special K-coding

Key Commercial Data

Packing unit	1 pc
GTIN	 4 055626 034720
GTIN	4055626034720

Technical data

Dimensions

Length of cable	3 m
-----------------	-----

Ambient conditions

Ambient temperature (operation)	-25 °C ... 85 °C (Plug / socket)
Degree of protection	IP65
	IP67 (without preloading, as additional test in accordance with IEC 60529)

General

Rated current at 40°C	16 A
Rated voltage	690 V AC
Number of positions	5
Color handle area	black
Insulation resistance	≥ 100 MΩ
Coding	K - Power

Power cable - SAC-5P-M12MRK/ 3,0-PVC PE - 1414839

Technical data

General

Standards/regulations	M12 connector IEC 61076-2-111
Status display	No
Protective circuit/component	unwired
Overvoltage category	III
Degree of pollution	3
Insertion/withdrawal cycles	≥ 100
Torque	0.4 Nm (M12 connector)

Material

Flammability rating according to UL 94	V0
Contact material	CuZn
Contact surface material	Ni/Au
Contact carrier material	PA
Material of grip body	PP
Material, knurls	Zinc die-cast, nickel-plated

Standards and Regulations

Standards/specifications	M12 connector IEC 61076-2-111
Flammability rating according to UL 94	V0

Cable

UL AWM style	2570 / 10914 (80°C/1000 V)
Conductor cross section	5x 2.5 mm ²
AWG power supply	14
Conductor structure, voltage supply	141x 0.15 mm
Core diameter including insulation	3 mm ±0.1 mm
Thickness, insulation	≥ 0.36 mm
Wire colors	Black 1, black 2, black 3, black 4, green/yellow
External sheath, color	black-gray RAL 7021
Outer sheath thickness	approx. 0.76 mm
External cable diameter D	10.75 mm ±0.3 mm
Minimum bending radius, fixed installation	5 x D
Minimum bending radius, flexible installation	10 x D
Number of bending cycles	2000000
Minimum bending radius, drag chain applications	10 x D
Traversing path	10 m
Traversing rate	3 m/s
Acceleration	10 m/s ²
Cable weight	220 kg/km
Outer sheath, material	PVC
Material conductor insulation	PVC
Conductor material	Bare Cu litz wires

Power cable - SAC-5P-M12MRK/ 3,0-PVC PE - 1414839

Technical data

Cable

Insulation resistance	$\geq 100 \text{ M}\Omega \cdot \text{km}$ (at 20 °C)
Conductor resistance	$\leq 8 \text{ }\Omega/\text{km}$ (at 20 °C)
Nominal voltage, cable	$\leq 1000 \text{ V AC}$
Test voltage, cable	$\geq 10000 \text{ V AC}$ (Spark test)
Flame resistance	According to UL 758/1581 (Cable Flame)
	according to UL 758/1581 FT1
	According to DIN EN 60332-1-2
Resistance to oil	According to DIN EN 60811-404, 168 h at 60 °C
Ambient temperature (operation)	-40 °C ... 80 °C (cable, fixed installation)
	-20 °C ... 80 °C (cable, flexible installation)

Environmental Product Compliance

REACH SVHC	Lead 7439-92-1
China RoHS	Environmentally Friendly Use Period = 50 years
	For details about hazardous substances go to tab "Downloads", Category "Manufacturer's declaration"

Drawings

Power cable - SAC-5P-M12MRK/ 3,0-PVC PE - 1414839

Dimensional drawing

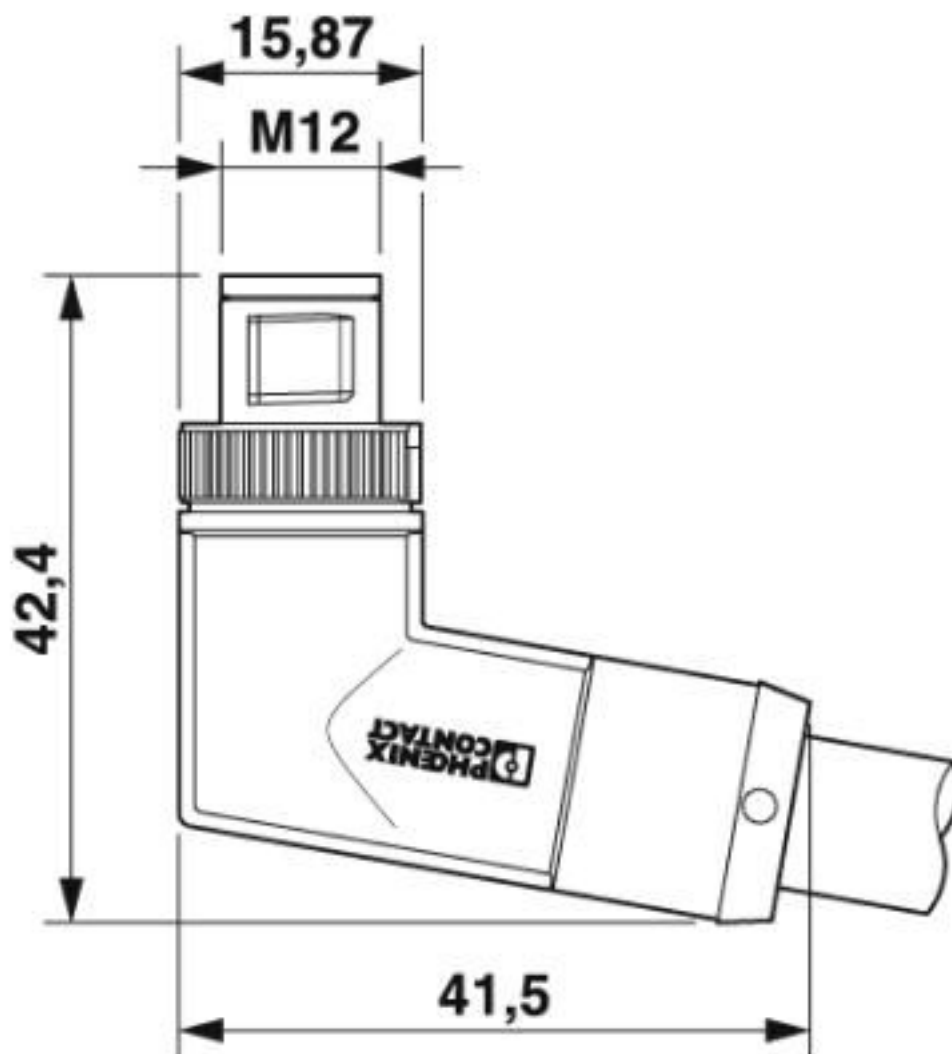

M12 x 1 male plug, angled

Power cable - SAC-5P-M12MRK/ 3,0-PVC PE - 1414839

Schematic diagram

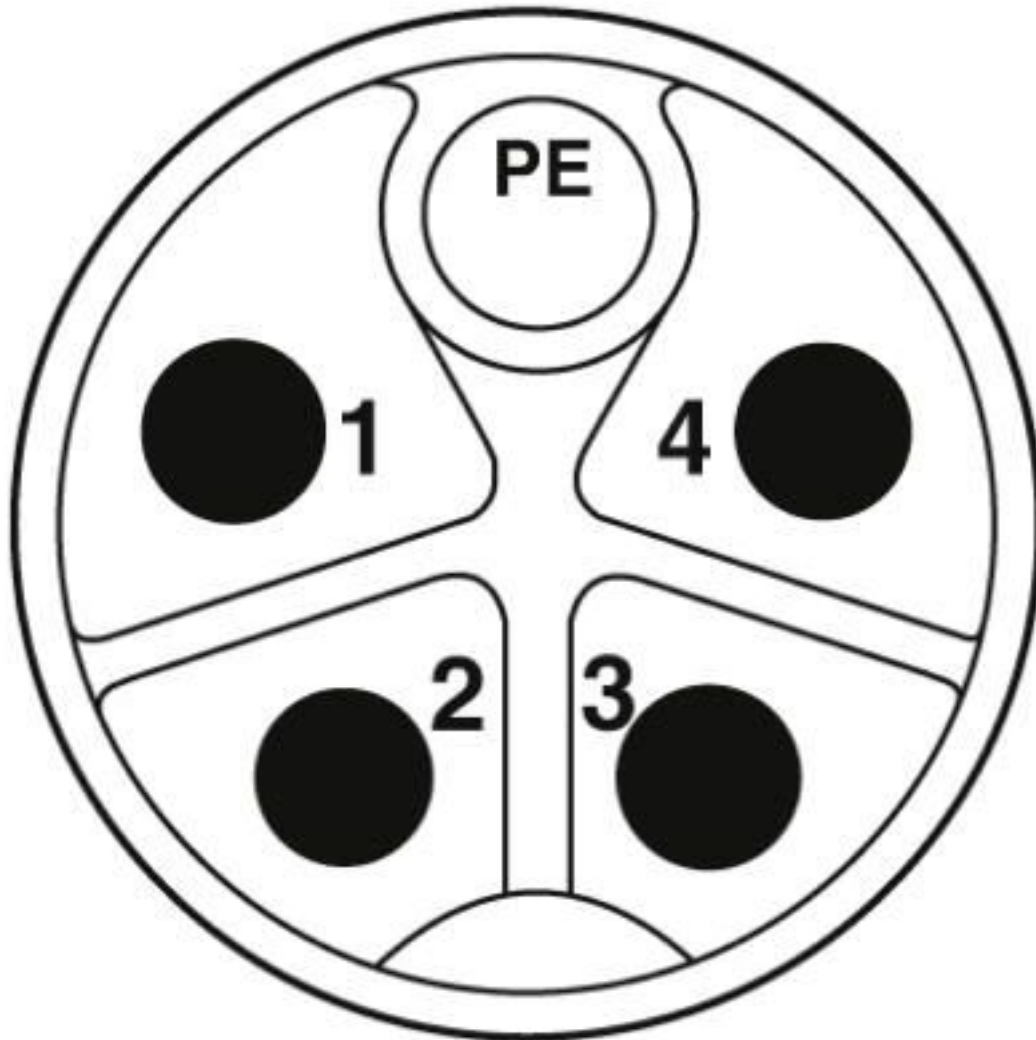

Connector pin assignment of M12 plug, 5-pos., K-coded, pin side view

Power cable - SAC-5P-M12MRK/ 3,0-PVC PE - 1414839

Diagram

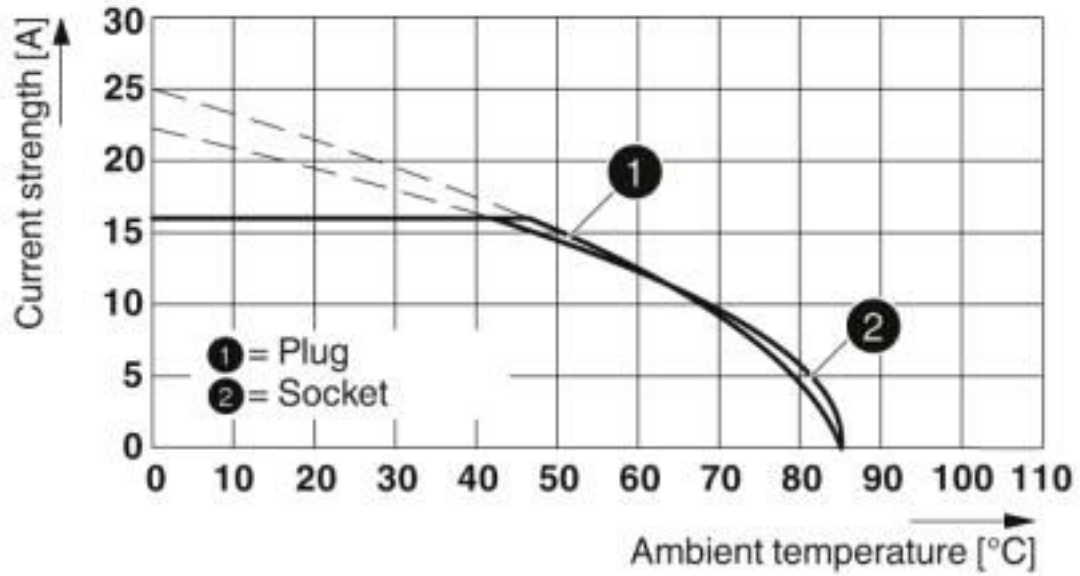

Circuit diagram

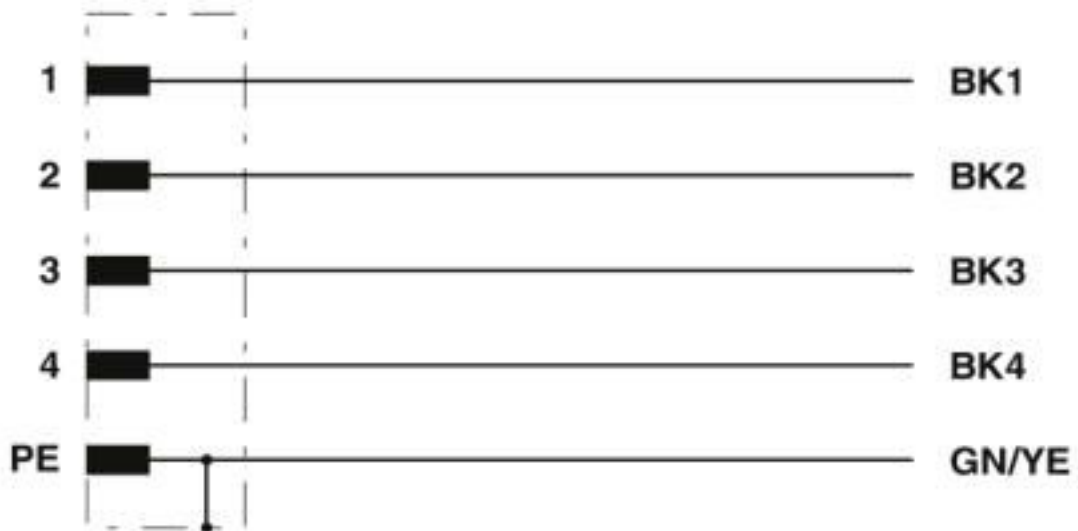

Contact assignment of the M12 plug

Power cable - SAC-5P-M12MRK/ 3,0-PVC PE - 1414839

Cable cross section



PVC black [PVC]

Classifications

eCl@ss

eCl@ss 10.0.1	27440203
eCl@ss 4.0	24010400
eCl@ss 4.1	24010400
eCl@ss 5.0	19030300
eCl@ss 5.1	19030300
eCl@ss 6.0	27279200
eCl@ss 7.0	27279218
eCl@ss 8.0	27440203
eCl@ss 9.0	27440203

Power cable - SAC-5P-M12MRK/ 3,0-PVC PE - 1414839

Classifications

ETIM

ETIM 5.0	EC002311
ETIM 6.0	EC002311
ETIM 7.0	EC002311

Approvals

Approvals

Approvals

UL Listed / cUL Listed / EAC-RoHS / EAC / cULus Listed

Ex Approvals

Approval details

UL Listed		http://database.ul.com/cgi-bin/XYV/template/LISEXT/1FRAME/index.htm	E468743
Nominal voltage UN		600 V	
Nominal current IN		16 A	
mm ² /AWG/kcmil		14	

cUL Listed		http://database.ul.com/cgi-bin/XYV/template/LISEXT/1FRAME/index.htm	E468743
Nominal voltage UN		600 V	
Nominal current IN		16 A	
mm ² /AWG/kcmil		14	

EAC-RoHS		RU D- DE.HB35.B.00387
----------	---	--------------------------

EAC		RU C- DE.BL08.B.00286
-----	---	--------------------------

Power cable - SAC-5P-M12MRK/ 3,0-PVC PE - 1414839

Approvals

cULus Listed



Accessories

Accessories

Protective cap

Sealing cap - PROT-M12 FS - 1560251



M12 sealing cap for unoccupied M12 plugs of the sensor/actuator cable, flush-type plugs and I/O devices in the field

Screwdriver tools

Tool - SAC BIT M12-D16 - 1200305



Nut for assembling sensor/actuator cables with M12 connector and M12 connectors for assembly, knurl diameter: 16 mm, for 4 mm hexagonal drive

Phoenix Contact 2020 © - all rights reserved
<http://www.phoenixcontact.com>

PHOENIX CONTACT GmbH & Co. KG

Flachsmarktstr. 8

32825 Blomberg

Germany

Tel. +49 5235 300

Fax +49 5235 3 41200

<http://www.phoenixcontact.com>

X-ON Electronics

Largest Supplier of Electrical and Electronic Components

Click to view similar products for [Sensor Cables / Actuator Cables](#) category:

Click to view products by [Phoenix Contact](#) manufacturer:

Other Similar products are found below :

[60963](#) [60964](#) [703000D02F2002](#) [703001D02F0602](#) [703001D02F300](#) [704000D02F120](#) [773032K02F030](#) [802027107404-1](#) [802027213811-1](#)
[804001A09M150](#) [805001A09M0502](#) [84914-0235](#) [84914-0237](#) [885030A09M020](#) [8R4J30E03C3003](#) [1200651332](#) [1200651713](#) [1200660844](#)
[1200660845](#) [1200661173](#) [1200680071](#) [1200720053](#) [1200720081](#) [1200720099](#) [1200720217](#) [1200800231](#) [1200860125](#) [1200870123](#)
[1200980102](#) [1200650267](#) [1200650298](#) [1200660183](#) [1200660782](#) [1200660849](#) [1200661295](#) [1200661297](#) [1200661342](#) [1200661343](#)
[1200670080](#) [1200670220](#) [1200680331](#) [1200720252](#) [1200730184](#) [1200860344](#) [1200870359](#) [1200870643](#) [1200980008](#) [1200980031](#)
[1210502211](#) [1210400542](#)