

## Power cable - SAC-5P-M12MRL/ 1,5-280 FE - 1414850

Please be informed that the data shown in this PDF Document is generated from our Online Catalog. Please find the complete data in the user's documentation. Our General Terms of Use for Downloads are valid (<http://phoenixcontact.com/download>)



Power cable, 5-position, PUR halogen-free, gray RAL 7001, Plug angled M12, coding: L, on free cable end, cable length: 1.5 m, for direct current up to 16 A/63 V

### Your advantages

- ✓ Easy and safe: 100% electrically tested plug-in components
- ✓ High-performance: DC connectors for up to 16 A and 63 V DC
- ✓ Protection against mismatching, thanks to special L-coding
- ✓ Our standard: robust halogen-free PUR cable

### Key Commercial Data

|              |   |
|--------------|---|
| Packing unit | 1 pc  |
| GTIN         | <br>4 055626 034829 |
| GTIN         | 4055626034829   |

### Technical data

#### Dimensions

|                 |       |
|-----------------|-------|
| Length of cable | 1.5 m |
|-----------------|-------|

#### Ambient conditions

|                                 |                                  |
|---------------------------------|----------------------------------|
| Ambient temperature (operation) | -25 °C ... 85 °C (Plug / socket) |
| Degree of protection            | IP65                             |
|                                 | IP67                             |

#### General

|                       |          |
|-----------------------|----------|
| Rated current at 40°C | 16 A     |
| Rated voltage         | 63 V DC  |
| Number of positions   | 5        |
| Color handle area     | black    |
| Insulation resistance | ≥ 100 MΩ |

# Power cable - SAC-5P-M12MRL/ 1,5-280 FE - 1414850

## Technical data

### General

|                              |                               |
|------------------------------|-------------------------------|
| Coding                       | L - Power                     |
| Standards/regulations        | M12 connector IEC 61076-2-111 |
| Status display               | No                            |
| Protective circuit/component | unwired                       |
| Overvoltage category         | III                           |
| Degree of pollution          | 3                             |
| Insertion/withdrawal cycles  | ≥ 100                         |
| Torque                       | 0.4 Nm (M12 connector)        |

### Material

|  |                              |
|--|------------------------------|
| Flammability rating according to UL 94 | V0                           |
| Contact material                       | CuZn                         |
| Contact surface material               | Ni/Au                        |
| Contact carrier material               | PA                           |
| Material of grip body                  | PP                           |
| Material, knurls                       | Zinc die-cast, nickel-plated |

### Standards and Regulations

|  |                               |
|--|-------------------------------|
| Standards/specifications               | M12 connector IEC 61076-2-111 |
| Flammability rating according to UL 94 | V0                            |

### Cable

|   |                                 |
|---|---------------------------------|
| Cable type                                      | PUR halogen-free gray           |
| Cable type (abbreviation)                       | 280                             |
| UL AWM style                                    | 20233 / 10493 (80°C/300 V)      |
| Conductor cross section                         | 5x 2.5 mm <sup>2</sup>          |
| AWG power supply                                | 14                              |
| Conductor structure, voltage supply             | 141x 0.15 mm                    |
| Core diameter including insulation              | 2.85 mm ±0.1 mm                 |
| Thickness, insulation                           | ≥ 0.31 mm                       |
| Wire colors                                     | Brown, white, blue, black, gray |
| External sheath, color                          | gray RAL 7001                   |
| Outer sheath thickness                          | approx. 0.76 mm                 |
| External cable diameter D                       | 9.65 mm ±0.25 mm                |
| Minimum bending radius, fixed installation      | 5 x D                           |
| Minimum bending radius, flexible installation   | 10 x D                          |
| Number of bending cycles                        | 4000000                         |
| Minimum bending radius, drag chain applications | 10 x D                          |
| Traversing path                                 | 10 m                            |
| Traversing rate                                 | 3 m/s                           |
| Acceleration                                    | 10 m/s <sup>2</sup>             |
| Cable weight                                    | 185 kg/km                       |

## Power cable - SAC-5P-M12MRL/ 1,5-280 FE - 1414850

### Technical data

#### Cable

|                                 |   |
|---------------------------------|---|
| Outer sheath, material          | PUR   |
| Material conductor insulation   | PP  |
| Conductor material              | Bare Cu litz wires  |
| Insulation resistance           | $\geq 1 \text{ G}\Omega \cdot \text{km}$ (at 20 °C)         |
| Conductor resistance            | $\leq 8 \text{ }\Omega/\text{km}$ (at 20 °C)                |
| Nominal voltage, cable          | $\leq 300 \text{ V AC}$                                     |
| Test voltage, cable             | $\geq 3000 \text{ V AC}$ (Spark test)                       |
| Flame resistance                | According to UL 758/1581 (Cable Flame)                      |
|                                 | according to UL 758/1581 FT1                                |
|                                 | According to DIN EN 60332-1-2                               |
| Halogen-free                    | in accordance with DIN VDE 0472 part 815                    |
|                                 | in accordance with DIN EN 50267-2-1                         |
| Resistance to oil               | according to DIN EN 60811-404, 168 h at 100 °C              |
| Other resistance                | Hydrolysis and microbe resistant as per VDE 0282 section 10 |
|                                 | Low adhesion  |
|                                 | abrasion-resistant  |
|                                 | Resistant to salt water                                     |
| Ambient temperature (operation) | -50 °C ... 80 °C (cable, fixed installation)                |
|                                 | -30 °C ... 80 °C (cable, flexible installation)             |

#### Environmental Product Compliance

|            |   |
|------------|---|
| REACH SVHC | Lead 7439-92-1  |
| China RoHS | Environmentally Friendly Use Period = 50 years  |
|            | For details about hazardous substances go to tab "Downloads", Category "Manufacturer's declaration" |

#### Drawings

# Power cable - SAC-5P-M12MRL/ 1,5-280 FE - 1414850

Dimensional drawing

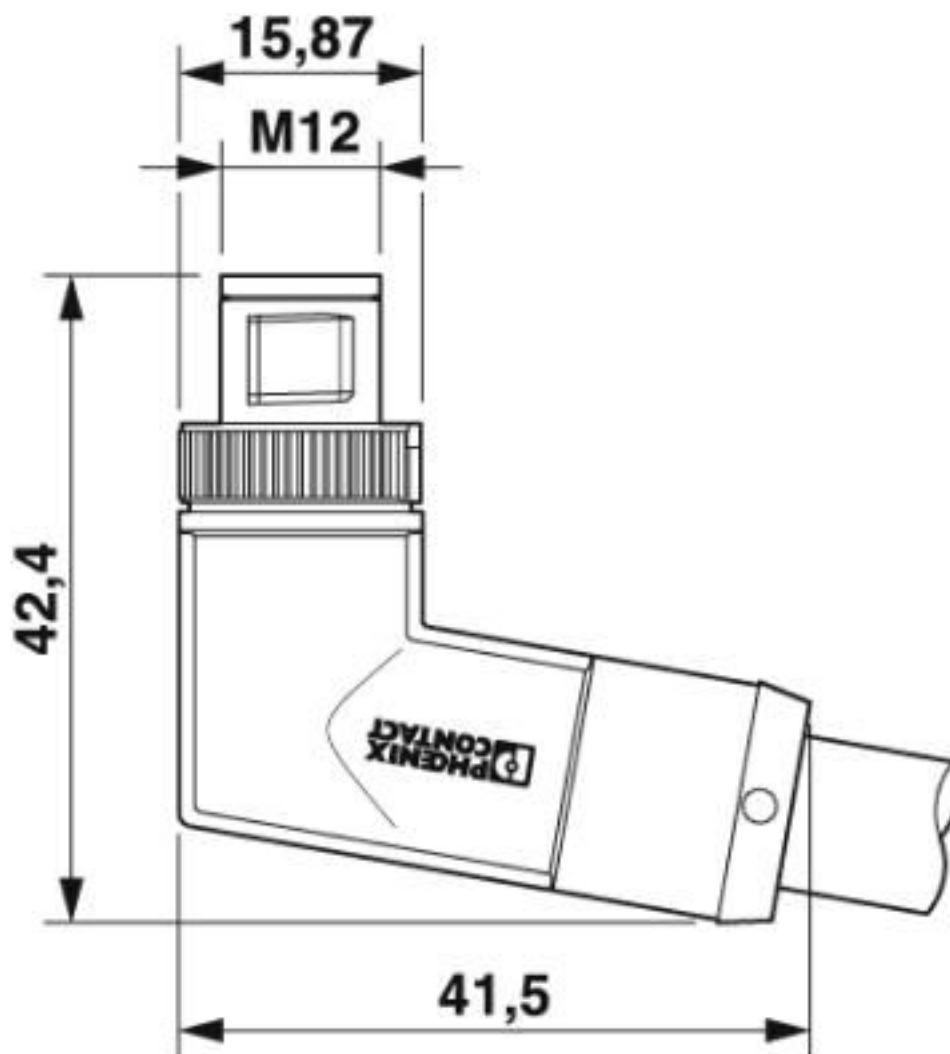

M12 x 1 male plug, angled

# Power cable - SAC-5P-M12MRL/ 1,5-280 FE - 1414850

Schematic diagram

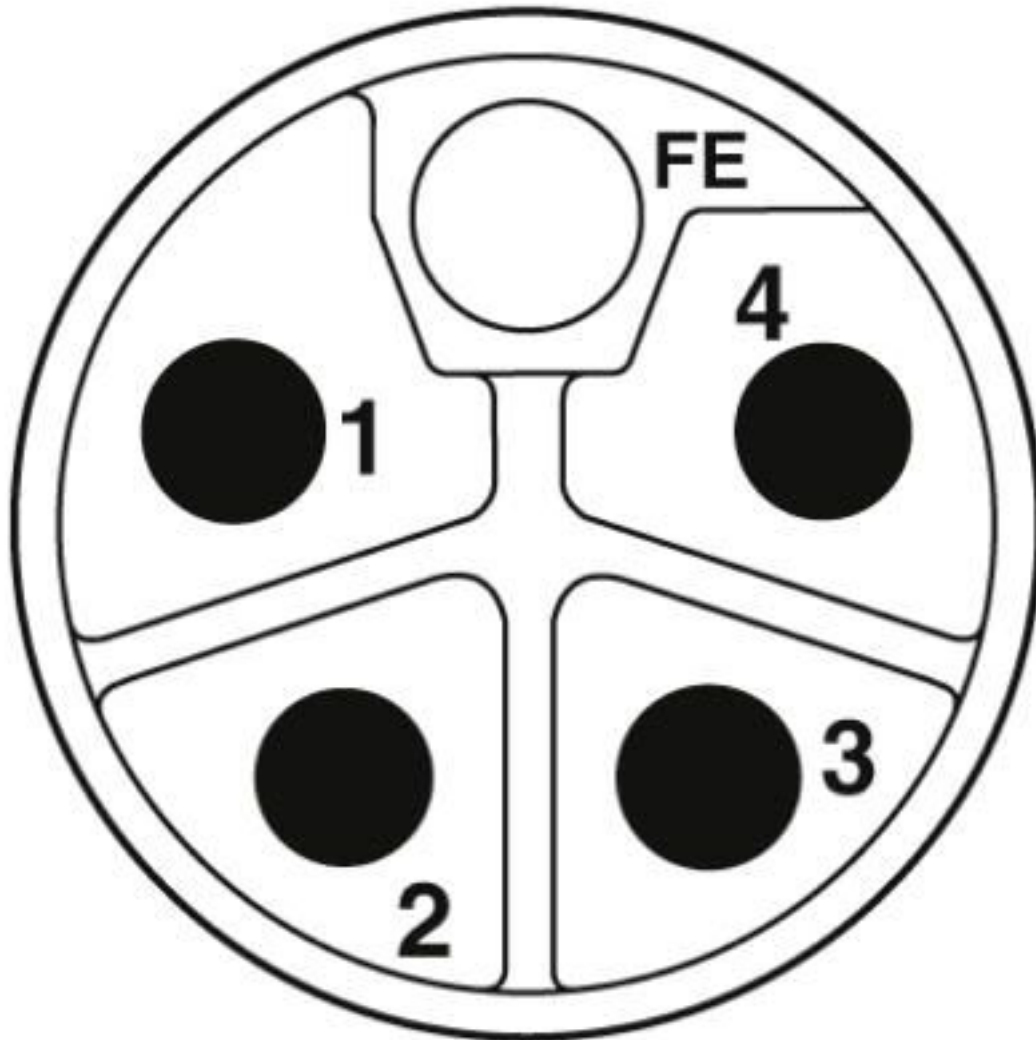

Pin assignment of M12 connector, 5-pos., L-coded, pin side view

# Power cable - SAC-5P-M12MRL/ 1,5-280 FE - 1414850

Diagram

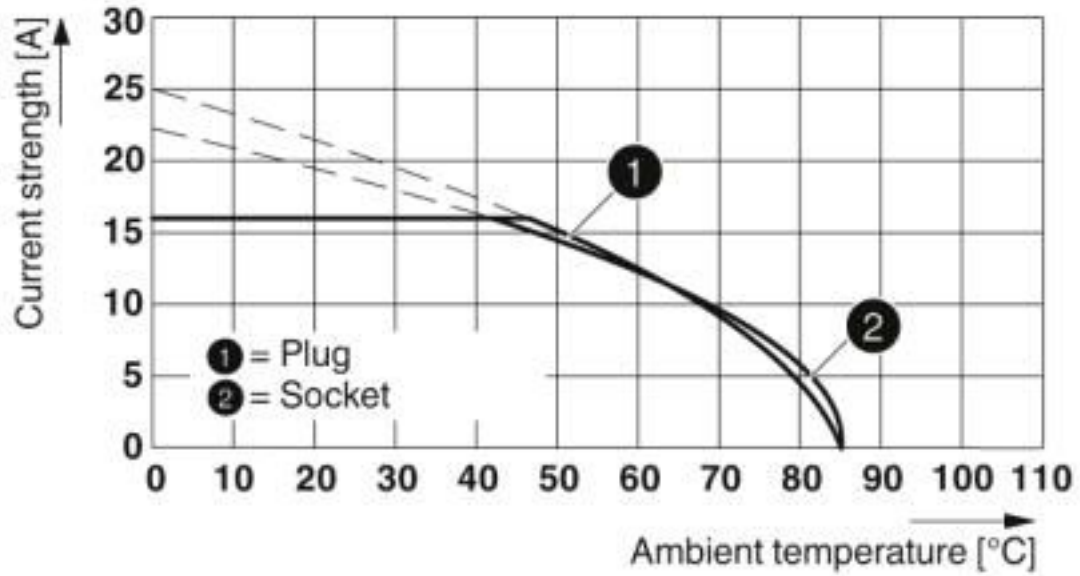

Current carrying capacity

Circuit diagram

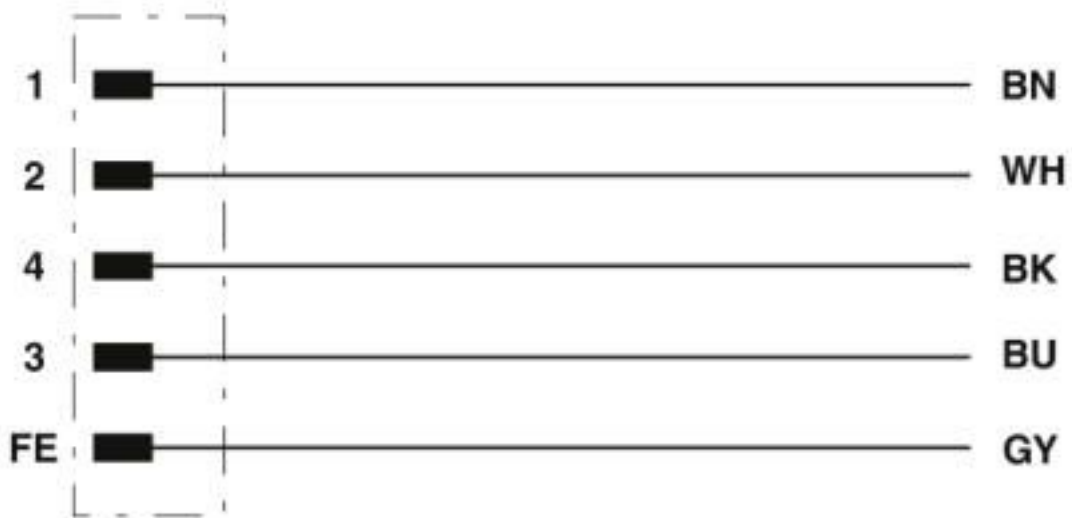

Contact assignment of the M12 plug

# Power cable - SAC-5P-M12MRL/ 1,5-280 FE - 1414850

Cable cross section

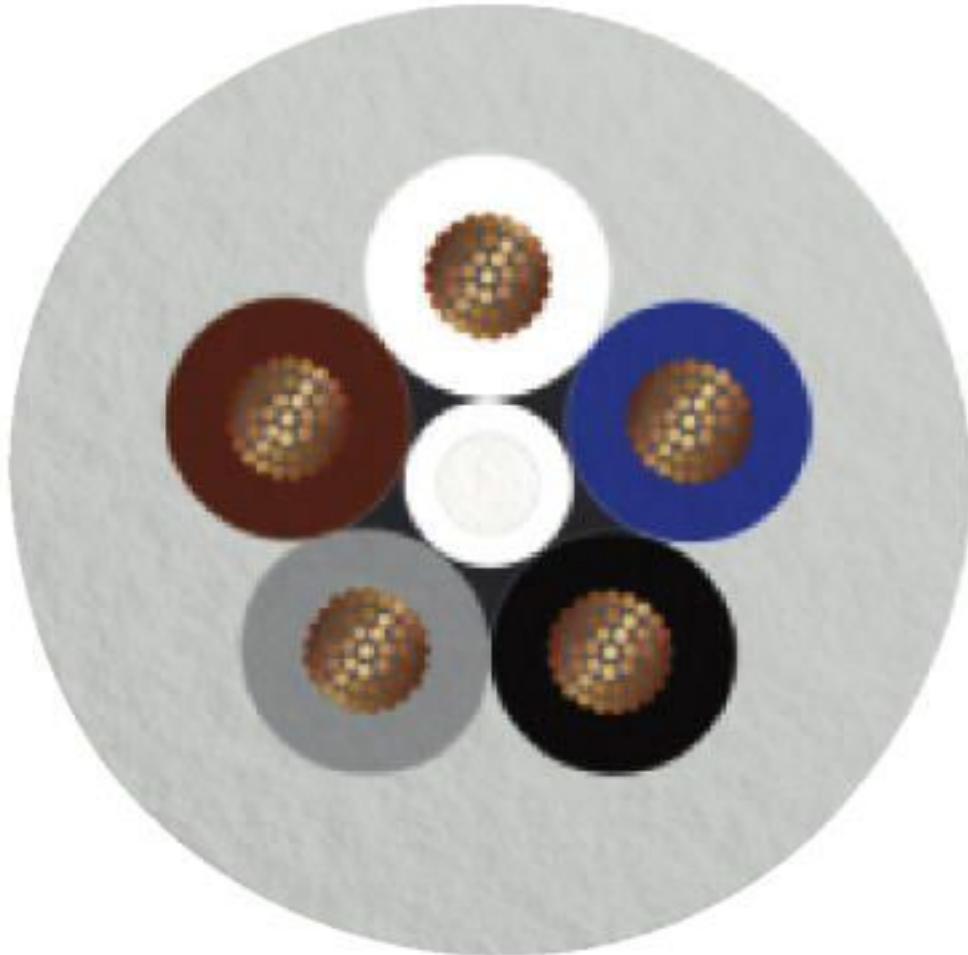

PUR halogen-free gray [280]

## Classifications

eCl@ss

|               |          |
|---------------|----------|
| eCl@ss 10.0.1 | 27440203 |
| eCl@ss 4.0    | 24010400 |
| eCl@ss 4.1    | 24010400 |
| eCl@ss 5.0    | 19030300 |
| eCl@ss 5.1    | 19030300 |
| eCl@ss 6.0    | 27279200 |
| eCl@ss 7.0    | 27279218 |
| eCl@ss 8.0    | 27440203 |
| eCl@ss 9.0    | 27440203 |

# Power cable - SAC-5P-M12MRL/ 1,5-280 FE - 1414850

## Classifications

### ETIM

|          |          |
|----------|----------|
| ETIM 5.0 | EC002311 |
| ETIM 6.0 | EC002311 |
| ETIM 7.0 | EC002311 |

## Approvals

### Approvals

#### Approvals

UL Listed / cUL Listed / EAC-RoHS / EAC / cULus Listed

#### Ex Approvals

### Approval details

|                            |   |   |         |
|----------------------------|---|---|---------|
| UL Listed                  |  | <a href="http://database.ul.com/cgi-bin/XYV/template/LISEXT/1FRAME/index.htm">http://database.ul.com/cgi-bin/XYV/template/LISEXT/1FRAME/index.htm</a> | E468743 |
| Nominal voltage UN         |   | 63 V  |         |
| Nominal current IN         |   | 16 A  |         |
| mm <sup>2</sup> /AWG/kcmil |   | 14  |         |

|                            |   |   |         |
|----------------------------|---|---|---------|
| cUL Listed                 |  | <a href="http://database.ul.com/cgi-bin/XYV/template/LISEXT/1FRAME/index.htm">http://database.ul.com/cgi-bin/XYV/template/LISEXT/1FRAME/index.htm</a> | E468743 |
| Nominal voltage UN         |   | 63 V  |         |
| Nominal current IN         |   | 16 A  |         |
| mm <sup>2</sup> /AWG/kcmil |   | 14  |         |

|          |   |                          |
|----------|---|--------------------------|
| EAC-RoHS |  | RU D-<br>DE.HB35.B.00387 |
|----------|---|--------------------------|

|     |   |                          |
|-----|---|--------------------------|
| EAC |  | RU C-<br>DE.BL08.B.00286 |
|-----|---|--------------------------|



## Power cable - SAC-5P-M12MRL/ 1,5-280 FE - 1414850

### Approvals

cULus Listed



### Accessories

#### Accessories

##### Protective cap

Sealing cap - PROT-M12 FS - 1560251



M12 sealing cap for unoccupied M12 plugs of the sensor/actuator cable, flush-type plugs and I/O devices in the field

### Screwdriver tools

Tool - SAC BIT M12-D16 - 1200305



Nut for assembling sensor/actuator cables with M12 connector and M12 connectors for assembly, knurl diameter: 16 mm, for 4 mm hexagonal drive

Phoenix Contact 2020 © - all rights reserved  
<http://www.phoenixcontact.com>

PHOENIX CONTACT GmbH & Co. KG  
Flachsmarktstr. 8  
32825 Blomberg  
Germany  
Tel. +49 5235 300  
Fax +49 5235 3 41200  
<http://www.phoenixcontact.com>

## X-ON Electronics

Largest Supplier of Electrical and Electronic Components

*Click to view similar products for [Sensor Cables / Actuator Cables](#) category:*

*Click to view products by [Phoenix Contact](#) manufacturer:*

Other Similar products are found below :

[60963](#) [60964](#) [703000D02F2002](#) [703001D02F0602](#) [703001D02F300](#) [704000D02F120](#) [773032K02F030](#) [802027107404-1](#) [802027213811-1](#)  
[804001A09M150](#) [805001A09M0502](#) [84914-0235](#) [84914-0237](#) [885030A09M020](#) [8R4J30E03C3003](#) [1200651332](#) [1200651713](#) [1200660844](#)  
[1200660845](#) [1200661173](#) [1200680071](#) [1200720053](#) [1200720081](#) [1200720099](#) [1200720217](#) [1200800231](#) [1200860125](#) [1200870123](#)  
[1200980102](#) [1200650267](#) [1200650298](#) [1200660183](#) [1200660782](#) [1200660849](#) [1200661295](#) [1200661297](#) [1200661342](#) [1200661343](#)  
[1200670080](#) [1200670220](#) [1200680331](#) [1200720252](#) [1200730184](#) [1200860344](#) [1200870359](#) [1200870643](#) [1200980008](#) [1200980031](#)  
[1210502211](#) [1210400542](#)